



Sportster® II Dual Fuel™ Stove

Dual Fuel™ Stove Instructions for use

© 2019 The Coleman Company, Inc.
www.coleman.com

533 Series



IMPORTANT

CONSUMER/USER: This instruction manual contains important information necessary for the proper assembly and safe use of the appliance. Read and follow all warnings and instructions before assembling and using the appliance. Follow all warnings and instructions when using the appliance. Keep this manual for future reference.

If you have questions about assembly, operation, servicing or repair of this appliance, please call Coleman at 1-800-835-3278 or TDD:1-316-832-8707. In Canada call 1-800-387-6161.

English

FOR YOUR SAFETY



Do not store or use gasoline or other liquids with flammable vapors in the vicinity of this or any other appliance.

DANGER



CARBON MONOXIDE HAZARD

- **This appliance can produce carbon monoxide which has no odor.**
- **Using it in an enclosed space can kill you.**
- **Never use this appliance in an enclosed space such as a camper, tent, car or home.**

This manual contains important information about the assembly, operation and maintenance of this outdoor liquid fueled appliance. General safety information is presented on this page and is also located throughout these instructions. Particular attention should be paid to information accompanied by the safety alert symbol “ DANGER”, “ WARNING”, “ CAUTION”.

Keep this manual for future reference and to educate new users of this product. This manual should be read in conjunction with the labeling on the product.

Safety precautions are essential when any Coleman® fueled equipment is involved. These precautions are necessary when using, storing, and servicing. Using this equipment with the respect and caution demanded will reduce the possibilities of personal injury or property damage.

The following symbols shown below are used extensively throughout these instructions. Always heed these precautions, as they are essential when using any Coleman® fueled equipment.

DANGER

DANGER indicates an imminently hazardous situation which, if not avoided, will result in death or serious injury.

WARNING

WARNING indicates a potentially hazardous situation which, if not avoided, could result in death or serious injury.

CAUTION

CAUTION indicates a potentially hazardous situation which, if not avoided, may result in minor or moderate personal injury, or property damage.

DANGER

Failure to comply with the precautions and instructions provided with these stoves can result in death, serious bodily injury and property loss or damage from hazards of fire, explosion, burn, asphyxiation, and/or carbon monoxide poisoning.

Only persons who can understand and follow the instructions should use or service these stoves.

If you need assistance or information such as an instruction manual or labels, contact The Coleman Company, Inc.

CALIFORNIA PROPOSITION 65:

 **WARNING:** This fuel, and byproducts or combustion of this fuel, contains Carbon Monoxide, which is known to the State of California to cause cancer and birth defects or other reproductive harm. For more information go to www.P65Warnings.ca.gov

WARNING

This multi-fuel appliance may be fueled by Coleman® Liquid Fuel or unleaded gasoline.

- Never use kerosene or leaded automotive fuel.
- Store fuel in a clean, properly marked container away from flame (including pilot lights), other sources of ignition, or excessive heat.

DANGER



• EXPLOSION - FIRE HAZARD

- During lighting and operation, this product can be a source of ignition. Never use the stove in spaces that contain or may contain volatile or airborne combustibles, or products such as gasoline, solvents, paint thinner, dust particles or unknown chemicals. Minimum clearances from combustible materials: 24 inches from the sides and 48 inches from the top.
- Provide adequate clearances around air openings into the combustion chamber.

DANGER



• EXPLOSION - FIRE HAZARD

- Coleman® Liquid Fuel and gasoline are extremely flammable; handle with care. Fuel vapors are invisible, explosive, and can be ignited by ignition sources may feet away.
- Always fill outdoors.
- Never open a pressurized Coleman® fuel tank or fill fuel tank near flame (including pilot lights), or other ignition sources. It is normal for a pressurized fuel tank to vent a small amount of fuel mist when unscrewing the fuel cap. Be sure stove has no flame before unscrewing the fuel cap.

WARNING

Not for home or recreational vehicle use.

We cannot foresee every use which may be made of our products.

Check with your local fire safety authority if you have questions about use.

Other standards govern the use of fuel and heat producing products for specific uses. Your local authorities can advise you about these.

- Use only Coleman® accessories or parts.
- During stove set-up, check all fittings for leaks using soapy water. Never use a flame.

WARNING



• BURN HAZARD

- Never leave stove unattended when hot or in use.
- Keep out of reach of children.

DANGER



• CARBON MONOXIDE HAZARD

- This stove is a combustion appliance. All combustion appliances produce carbon monoxide (CO) during the combustion process. This product is designed to produce extremely minute, non-hazardous amounts of CO if used and maintained in accordance with all warnings and instructions. Do not block air flow into or out of the stove.
- Carbon Monoxide (CO) poisoning produces flu-like symptoms, watery eyes, headaches, dizziness, fatigue and possibly death. You can't see it and you can't smell it. It's an invisible killer. If these symptoms are present during operation of this product **get fresh air immediately!**
- **For outdoor use only.**
- **Never use inside house, camper, tent, vehicle or other unventilated or enclosed areas. This stove consumes air (oxygen). Do not use in unventilated or enclosed areas to avoid endangering your life.**

CAUTION

• SERVICE SAFETY

- Keep all connections and fittings clean. Inspect fuel cap for dirt or damage after refilling the fuel tank. Wipe up any spilled fuel and dispose of in a safe place.
- Use as a cooking appliance only. Never alter in any way or use with any device or part not expressly approved by Coleman®.
- Clean stove frequently to avoid grease accumulation and possible grease fires.
- Check all connections for leaks. **Liquid fuel present at connections indicates a leak.**

Technical Characteristics

Input: 10,500 BTU/HR Coleman® Liquid Fuel or unleaded gasoline.

Category: Direct pressure multi-fuel stove.

Fuel: Coleman® Liquid Fuel or unleaded gasoline.

⚠ WARNING

1. Coleman® Liquid Fuel is extremely flammable, handle with extreme care. Fuel vapors are invisible, explosive, and can be ignited by ignition sources many feet away.
2. Always fill outdoors. Never open or fill fuel tank near flame (including pilot lights), or other ignition sources. It is normal for a pressurized fuel tank to vent a small amount of fuel mist when unscrewing the fuel cap.
3. Always light and use stove outdoors; never inside house, camper, tent, or other unventilated or enclosed areas.
4. **This stove consumes air (oxygen). Do not use in unventilated or enclosed areas to avoid endangering your life.**
5. This stove is designed to use Coleman® Liquid Fuel or unleaded gasoline.
6. Store fuel in a clean, properly marked container away from flame (including pilot lights), other sources of ignition, or excessive heat.
7. Use for cooking only. Never alter in any way or use with any device or part not expressly approved by Coleman®. Never use as a space heater. Never leave stove unattended while burning.
8. Keep stove away from flammables. Never allow fabric, clothing, or any flammable material come within 48 inches of the top and 24 inches of all sides of the stove.
9. When stove is in use, all metal parts of the stove assembly and generator become extremely hot. **DO NOT TOUCH.**
10. Never place heavy or large capacity utensils on stove.
11. **Keep out of reach of children.**

Thank you for purchasing your new Coleman® multi-fuel stove. We recommend operating your new stove in a safe location outside your home to familiarize yourself with its multi-fuel operation before your next outdoor experience.

Helpful Hints

- Coleman® Liquid Fuel is recommended when using the stove in temperatures below 40° F or in high elevation.
- For best results, always use Coleman® Filter/Funnel Part No. 5103A700T.
- If necessary, unleaded gasoline may be substituted for Coleman® Liquid Fuel.
- Do not use kerosene in this stove.

To Set Up

⚠ DANGER



• CARBON MONOXIDE HAZARD

- For outdoor use only.
- Never use inside house, camper, tent, vehicle or other unventilated or enclosed areas. This lantern consumes air (oxygen). Do not use in unventilated or enclosed areas to avoid endangering your life.

Filling the tank

Always fill outdoors. Never fill tank, loosen or remove fuel cap near flame (including pilot lights), or other ignition sources.

■ With stove on level surface, move RED FUEL LEVER to off position. (Fig. 1)

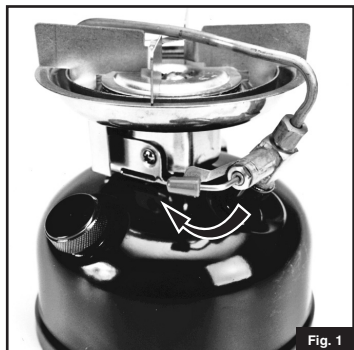

Fig. 1

- Close PUMP KNOB firmly. (Fig. 2)



Fig. 2

- Remove FUEL CAP. Using a funnel or suitable filling device, fill with clean, fresh fuel (Fig. 3). Do not tip stove.
- Replace FUEL CAP on fuel container. Tighten firmly. Move fuel container away from stove. WIPE UP ANY SPILLED FUEL AND DISPOSE OF IN A SAFE PLACE.



Fig. 3

Pumping

Be sure RED FUEL LEVER is in off position. (Fig. 4)

- Open PUMP KNOB one full turn. (Fig. 5)



Fig. 4



Fig. 5

- With thumb over hole in PUMP KNOB, pump approximately 30 full strokes. (Fig. 6)



Fig. 6

- Close PUMP KNOB. (Fig. 7)



Fig. 7

Leak Check

- Make sure FUEL VALVE is fully "OFF".
- CHECK FOR LEAKS in one or more ways. Look for fuel mist or a wet appearance of fuel on surfaces. Listen for hiss of escaping gas. Smell for fuel odor. Never use a flame. Do not use if leaking. (Fig. 8)

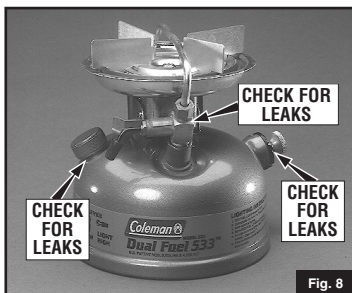

Fig. 8

To Light

⚠ WARNING

- Perform leak test outdoors.
- Extinguish all open flames.
- NEVER leak test when smoking.
- Do not use the outdoor stove until connection has been leak tested and does not leak.

⚠ WARNING



• BURN HAZARD

- Never leave stove unattended when hot or in use.
- Keep out of reach of children.

NEVER FILL OR LIGHT STOVE INSIDE HOUSE, CAMPER, OR TENT.

- Hold lit match at BURNER, then turn RED FUEL LEVER to high (LIGHT) position. (Fig. 9)



- When burner lights, open PUMP KNOB one turn (Fig. 10) and pump for 30 full strokes (Fig. 11).



- Close PUMP KNOB. (Fig. 12)

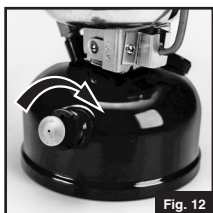

- **CAUTION:** If fuel or flames appear below BURNER, immediately turn RED FUEL LEVER off. Allow stove to cool. Turn stove upside down to empty any fuel accumulated in burner and wipe dry. Review instructions then relight stove.

- Adjust flame to desired heat with RED FUEL LEVER. (Fig. 13)



- Additional pumping may be required for full heat output (Fig. 14)



For temperatures below freezing

- Note: In temperatures below freezing preheating paste may be required. Place a generous amount of PRE-HEATING PASTE on BURNER CAP beneath the GENERATOR. (Fig. 15)



- Light the paste (Fig. 16). After the paste is almost consumed, follow the previous lighting instructions.



To Turn Off

- Move RED FUEL VALVE from off to high several times. (Fig. 17)



- Latch RED FUEL VALVE in off position. (Fig. 18)



- Be sure flame is extinguished. Flame will linger on burner for 1-2 minutes after fuel valve is "OFF".

⚠ WARNING

- Always turn fuel valve off before unscrewing fuel cap from fuel tank. Never remove fuel cap near ignition sources, while stove is lit, or hot to touch.

To Transport

- Allow to cool completely before transporting. Transport in an upright position.

To Store

- Make sure stove is cool.
- Move stove away from flame (including pilot lights) and other ignition sources.

• MAINTENANCE

- Keep stove area clear and free from combustible materials, gasoline and other flammable vapors and liquids.
- Do not obstruct the flow of combustion and ventilation air.
- A good flame should be blue with minimal yellow tip. Some yellow tips on flames are acceptable as long as no carbon or soot deposits appear.
- Wipe clean with soft cloth and mild dish detergent. Do not use abrasives.

Troubleshooting

Symptom	Problem	Solution
Burner will not light or flame self-extinguished.	Fuel tank empty.	Refill fuel tank with clean and fresh Coleman® Liquid Fuel or unleaded fuel.
Burner will not light or flame is low or flame self-extinguished.	Little or no pressure in fuel tank.	Check that fuel cap is tight and pump 30 strokes.
Burner self-extinguishes during one minute warm-up.	Generator is not fully warmed up.	In temperatures below freezing preheating paste may be required. Place a generous amount of preheating paste on burner cap beneath the generator.
Yellow flame.	Excess fuel in burner.	A yellow flame is normal until the generator warms up. If yellow flame persists, turn off stove, allow flame to self-extinguish and the stove to cool. If necessary, invert stove to remove excess liquid fuel from the burner. Follow lighting instructions.
Low heat.	Generator tip plugged.	Turn red fuel lever back and forth several times to clean generator tip. Be sure to use only fresh and clean fuel.
Low heat.	Faulty generator.	Replace with a new generator. This is a normal periodic maintenance procedure. The generator life is dependent on the type of fuel used. Generator life is extended by using clean Coleman® Liquid Fuel.
Persistent small yellow flame.	Faulty generator.	Replace with a new generator.
Persistent high yellow flame.	Failure in the fuel delivery system.	May need to replace pump assembly. Please contact Consumer Service (see page 9).
Yellow smokey flame.	Spider webs, insects, or other obstruction in the burner and air tube.	Remove burner to inspect and clean the burner and air tube.
Pump does not pressurize the liquid fuel canister.	Pump seals are dry or worn.	Squirt a few drops of oil in the OIL HOLE in the pump cap. This will keep the pump functioning properly (Fig. 19). If this does not correct the problem, replace the pump seals or purchase a new pump assembly.
Intermittent yellow flame after extended use on low heat setting.	Flame requires adjustment.	Adjust the flame to a slightly higher level with the red fuel lever.

Replacement Parts List

No.	Part No.	Description
1	220C1401	Fuel Cap
2	220A6201	Pump Repair Kit
3	3000005101	Generator
4	508A5571	Valve Assembly
5	400-3451	Burner Ring Set
6	413C3021	Burner Bowl
7	639-1091	Pump Cup & Nut
8	400-0601	Screw Pkg. (6)
9	200-6381	Check Valve & Stem Assy.
10	400B5151	Valve Stem Assy.

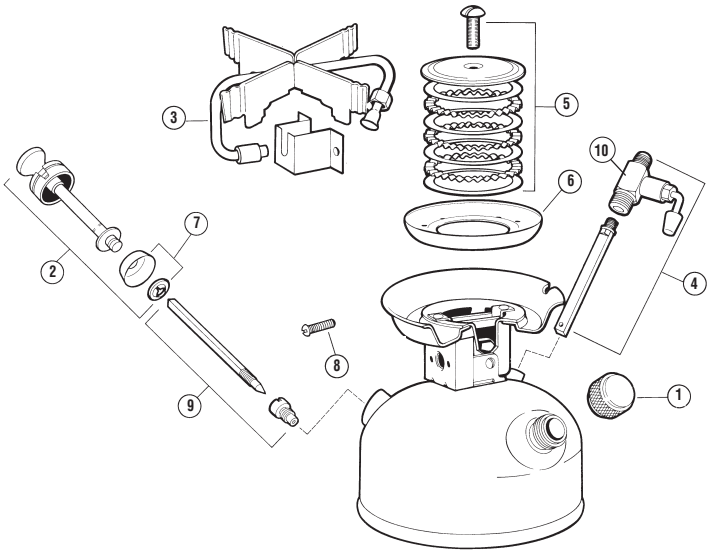

Warranty

Limited Five Year Warranty

The Coleman Company, Inc. ("Coleman") warrants that for a period of five (5) years from the date of original retail purchase, this product will be free from defects in material and workmanship. Coleman, at its option, will repair or replace this product or any component of the product found to be defective during the warranty period. Replacement will be made with a new or remanufactured product or component. If the product is no longer available, replacement may be made with a similar product of equal or greater value. This is your exclusive warranty.

This warranty is valid for the original retail purchaser from the date of initial retail purchase and is not transferable. Keep the original sales receipt. Proof of purchase is required to obtain warranty performance. Coleman dealers, service centers, or retail stores selling Coleman® products do not have the right to alter, modify or in any way change the terms and conditions of this warranty.

What This Warranty Does Not Cover

This warranty does not cover normal wear of parts, parts that are not genuine Coleman® parts, or damage resulting from any of the following: negligent use or misuse of the product; commercial use of the product; use contrary to the operating instructions; disassembly, repair or alteration by anyone other than Coleman or an authorized service center. Further, the warranty does not cover Acts of God, such as fire, flood, hurricanes and tornadoes. Warranty void if damage to the product results from the use of a part other than a genuine Coleman® part.

COLEMAN SHALL NOT BE LIABLE FOR DEFECTS THAT ARE CAUSED BY THE USE OF UNAUTHORIZED PARTS OR SERVICE. COLEMAN SHALL NOT BE LIABLE FOR ANY INCIDENTAL OR CONSEQUENTIAL DAMAGES CAUSED BY THE BREACH OF ANY EXPRESS OR IMPLIED WARRANTY OR CONDITIONS. EXCEPT TO THE EXTENT PROHIBITED BY APPLICABLE LAW, ANY IMPLIED WARRANTY OF MERCHANTABILITY OR FITNESS FOR A PARTICULAR PURPOSE IS LIMITED IN DURATION TO THE DURATION OF THE ABOVE WARRANTY OR CONDITIONS. SOME STATES OR JURISDICTIONS DO NOT ALLOW THE EXCLUSION OR LIMITATION OF INCIDENTAL OR CONSEQUENTIAL DAMAGES OR LIMITATIONS ON HOW LONG AN IMPLIED WARRANTY LASTS, SO THE ABOVE LIMITATIONS OR EXCLUSION MAY NOT APPLY TO YOU. THIS WARRANTY GIVES YOU SPECIFIC LEGAL RIGHTS, AND YOU MAY ALSO HAVE OTHER RIGHTS THAT VARY FROM STATE TO STATE.

How to Obtain Warranty Service

Take the product to an authorized Coleman® service center. You can find the nearest authorized Coleman® service center by visiting www.coleman.com or calling 1-800-835-3278 or TDD 1-316-832-8707. If a service center is not conveniently located, attach to the product a tag that includes your name, address, daytime telephone number and description of the problem. Include a copy of the original sales receipt. Carefully package the product and send either by courier or insured mail with shipping and insurance prepaid to:

The Coleman Company, Inc.
3600 North Hydraulic
Wichita, KS 67219

The costs of transporting the product to Coleman or an authorized service center for warranty service is the responsibility of the purchaser.

Do not mail products with fuel in tanks, or with disposable propane cylinders.

DO NOT RETURN THIS PRODUCT TO THE PLACE OF PURCHASE.

If you have any questions regarding this warranty please call 1-800-835-3278 or TDD 1-316-832-8707.

Things You Should Know

1. Preheating paste is available at most stores that sell backpacking equipment.
2. Rinse tank twice a year with fresh fuel to remove sediment, gum formations, and moisture accumulations.
3. Seasonally or before storage, squirt a few drops of oil into the OIL HOLE in the pump cap. This will keep the pump functioning properly. (Fig. 19)





4. The red fuel lever moves a small needle in and out of the generator gas tip. If stove is hard to light or does not produce full heat output, turn red fuel lever back and forth several times to clean generator.
5. Unleaded fuels may vary in quality and can affect generator life and performance. If you are having a problem with your stove or generator using unleaded fuel, replace the generator and try a different brand of unleaded fuel.
6. The usual storage areas for camping and picnic equipment are the basement, attic, or garage. To avoid the accumulation of dust, cobwebs, etc., that is common in these areas, place your stove in a plastic bag and seal it with a rubber band.
7. For repair service call one of the numbers listed below for location of your nearest Coleman® Service Center. If stove must be mailed to a Service Center, attach to the product a tag that includes your name, address, daytime telephone number and a description of problem. Do NOT send LPG canister. Carefully package the product and send either by **courier** or **insured mail** with shipping and **insurance** prepaid to:

The Coleman Company, Inc.
3600 N. Hydraulic • Wichita, KS 67219 U.S.A.
1-800-835-3278 • TDD:1-316-832-8707
8. If not completely satisfied with the performance of this product, please call one of the numbers listed above.



The Coleman Company, Inc. • 3600 North Hydraulic • Wichita, KS 67219 U.S.A.
1-800-835-3278 • TDD:1-316-832-8707

© 2019 The Coleman Company, Inc. All rights reserved. Coleman®, , , and Sportster® are registered trademarks and Dual Fuel™ is a trademark of The Coleman Company, Inc.

www.coleman.com

4010008346 (ECN20067638-04)