



www.gracobaby.com

Contender™ GO

CONVERTIBLE CAR SEAT

Read This Instruction Manual

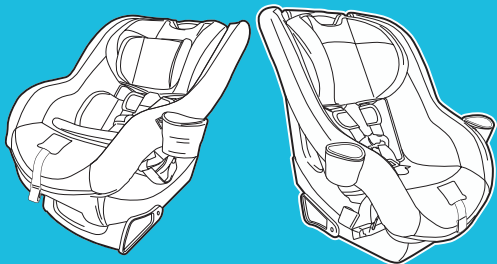

NWL0001299514C 8/21

Do not install or use this child restraint until you read and understand the instructions in this manual.

FAILURE TO PROPERLY USE THIS CHILD RESTRAINT INCREASES THE RISK OF SERIOUS INJURY OR DEATH IN A SUDDEN STOP OR CRASH.

1 Important

Pages 6-23

1-A A Quick Guide to Your Manual

1-B Welcome to the Graco Family!

1-C Right Mode of Use

1-D Before You Begin

Register This Child Restraint

If You Need Help

Certification

Car Seat's Useful Life

Vehicle Seat Protection

Warm Weather Use

1-E Safety Warnings

2 Features

Pages 24-29

2-A Car Seat Features

3 Rear-Facing

Pages 30-44

3-A Rear-Facing Use

3-B Install Rear-Facing with Lower Anchor Attachment

3-C Install Rear-Facing with Vehicle Seat Belt

4 Forward-Facing

Pages 45-58

4-A Forward-Facing Use

4-B Install Forward-Facing with LATCH

4-C Install Forward-Facing with Vehicle Seat Belt

5 Securing Child

Pages 59-66

5-A Securing Child 5-Point Harness

6 Accessories

Pages 67-68

6-A Accessories

7 Moving the Lower Anchor Attachment *Pages 69-71*

7-A Moving the Lower Anchor Attachment

8 Vehicle Information

Pages 72-82

- 8-A How to Uninstall Lower Anchor Connectors and Tether**
- 8-B Choosing Vehicle Seat Location**
- 8-C Unsafe Vehicle Seat Locations**
- 8-D Vehicle Seat Belts**

9 Care & Cleaning

Pages 83-86

- 9-A Cleaning Seat Pad**
- 9-B Cleaning Buckle**
- 9-C Cleaning Harness, Lower Anchor Attachment and Tether**



1-A A Quick Guide to Your Manual

This car seat is for children: ***Rear-Facing: 5-40 lb (2.2-18 kg)***
 Forward Facing: 22-65 lb (10-30 kg)

- Children less than 22 lb (10 kg) **MUST** use this car seat rear-facing. Review section 1-C for more information.

Note: Preterm or low birth weight infants may be at special risk in a vehicle or aircraft. According to the AAP, these infants may suffer breathing issues if improperly reclined in a car seat. When rear-facing, use the corrected age for preemies. Graco advises that you have your physician or hospital staff evaluate your infant and recommend the proper car seat or car bed before you and your infant leave the hospital.

Get to Know Your Car Seat

Review section 2-A to see all of the features of this infant car seat.

What Seating Location Should I Use?

The best seating location for this infant car seat is one that:

- Is recommended by your vehicle owner's manual, and
- Results in a secure installation of this car seat.

Some vehicles have specific requirements for where the car seat can be installed, so be sure to check your vehicle owner's manual for available seating positions, if any.

Review section 8-B, 8-C and 8-D of this manual AND your vehicle owner's manual.

! WARNING!



NEVER place this child restraint rear-facing in a vehicle seating location that has an active front air bag.

In the event there is no back seat, review your vehicle owner's manual to see how to use your child restraint.

According to accident statistics, children are safer when properly restrained in the rear seating positions than in the front seating positions. The center of the back seat can be the safest during a possible side impact.



i
1 Important

Which Installation Method Should I Use?

This car seat can be installed in your vehicle using either the vehicle seat belt **OR** the lower anchor attachment. Both are equally safe to use. **INSTALL USING ONLY ONE METHOD.**

Vehicle Seat Belt: Review section 8 and your vehicle owner's manual to learn how to install your car seat with the vehicle seat belts.

LATCH or Lower Anchor Attachment: The LATCH system or lower anchor attachment allows you to securely attach your safety seat in your car without using the vehicle seat belt and possibly to get a better fit. All 2003 and newer model year vehicles are required to have a LATCH system, although some manufacturers began including LATCH earlier. Some vehicle owner manuals use the term ISOFIX to identify the LATCH system.

What is LATCH?

LATCH consists of lower anchors and a tether anchor, which are built in to your vehicle, and a lower anchor attachment and a tether that are built into your car seat. The lower anchor attachment is used **INSTEAD** of the vehicle's seat belt to secure the child seat to the vehicle. The tether is used **IN ADDITION** to the lower anchor attachment **OR** the vehicle's seat belt to secure a forward-facing car seat to the vehicle.

Review your vehicle owner's manual for exact location and use.

**Vehicle Tether
Anchor Points**

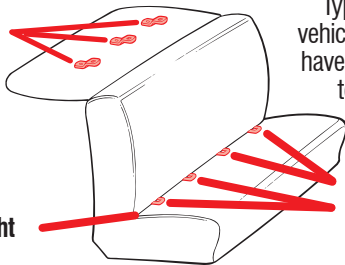

Vehicle Seat Belt

Typical seat in a passenger vehicle. Other vehicle types may have different lower anchor and tether anchor locations.

**Vehicle Lower
Anchor Points**



When Installing This Car Seat

Lower Anchor Attachment

The lower anchor attachment consists of two lower anchors, which are built in to your vehicle, and lower anchor connectors that are built in your car seat. Review section 3-B & 4-B of this manual AND your vehicle owner's manual before installing.

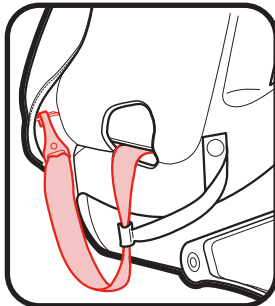
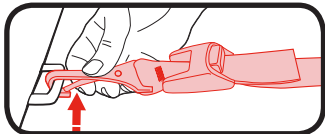

Vehicle Seat Belt

There are two types of vehicle seat belts that can be used. Lap/Shoulder Seat Belt or Lap Only Seat Belt. Review section 3-C & 4-C of this manual AND your vehicle owner's manual before installing.

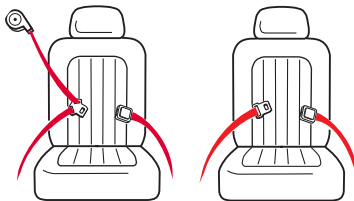

i 1 Important

Does Your Car Seat Fit Your Child Correctly?

To make sure your child is secured properly, review section 3, 4 and 5 to understand all of the actions you need to take to properly adjust the car seat to fit your child.

For Rear-Facing, You Need to Adjust:

Harness Height, Rear-Facing

Harness straps at or just below the child's shoulders **(A)** and top of head **must** be 1" (2.5 cm) below the headrest adjustment handle **(B)**. Review section 5.

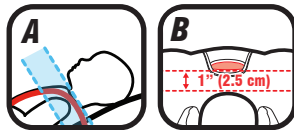

Buckle Position (C)

The correct slot is the one that is closest to your child without being underneath them. Review section 5.

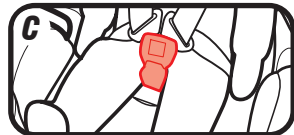

Harness Tightness (D)

If your fingers slide off the harness straps without pinching the straps, it is tight enough. Review section 5.

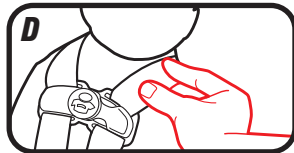

For Forward-Facing, You Need to Adjust:

Harness Height, Forward-Facing

Harness straps at or just above the child's shoulders **(A)** and top of child's ears below top of headrest **(B)**. Review section 5.

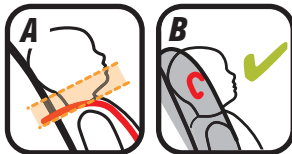

Buckle Position (C)

The correct slot is the one that is closest to your child without being underneath them. Review section 5.

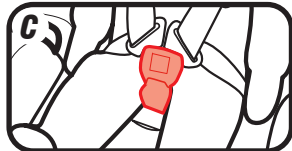

Harness Tightness (D)

If your fingers slide off the harness straps without pinching the straps, it is tight enough. Review section 5.

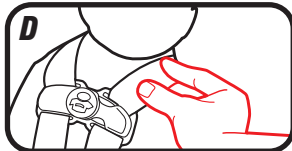

i 1 Important

Did You Do Everything Correctly?

Rear-Facing Installation

Car Seat Does Not Move More than 1” (2.5 cm) at the Belt Path (A)

Review section 3

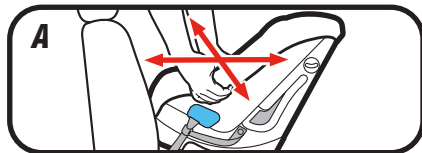

Level Indicator's Ball in the Correct Blue Zone (B)

Review section 3

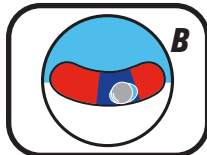

Harness Straps at or Just Below Child's Shoulders (C)

Review section 5



Chest Clip Even With Armpits (D)

Review section 5

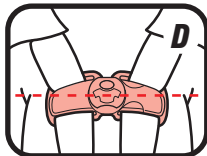

Cannot Pinch Harness Straps at the Shoulder (E)

Review section 5



Forward-Facing Installation

Use the Tether Strap when using Forward-Facing (A)

When used properly, the tether helps reduce injury in a sudden stop or crash.

Review section 4

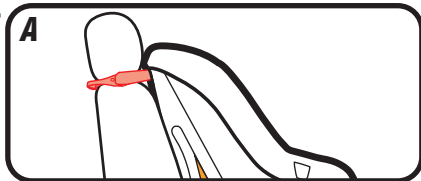

Car Seat Does Not Move More than 1" (2.5 cm) at the Belt Path (B)

Review section 4

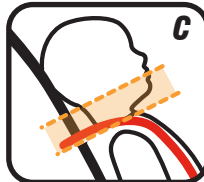
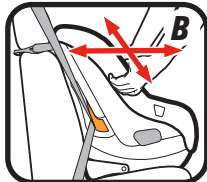

Harness Straps at or Just Above Child's Shoulders (C)

Review section 5

Chest Clip Even With Armpits (D)

Review section 5

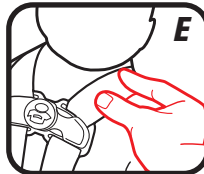
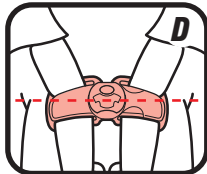

Cannot Pinch Harness Straps at the Shoulder (E)

Review section 5

i 1 Important



1 Important

1-B Welcome to the Graco Family!

Your child's safety depends on you. No car seat can guarantee protection from injury in every situation, but proper use helps reduce the risk of serious injury or death.

Even if this car seat seems easy to figure out on your own, you must follow the detailed instructions in this instruction manual to ensure the steps below are performed correctly.

1-C Right Mode of Use



1 Important

5 lb
(2.2 kg)

22 lb
(10 kg)

40 lb
(18 kg)

65 lb
(30 kg)

Rear-Facing with 5-Point Harness

Must be 49" (125 cm) or less:

5-22 lb (2.2-10 kg) less than 1 year old **MUST** be rear-facing.

22-40 lb (10-18 kg) **SHOULD** be rear-facing.*

Forward-Facing with 5-Point Harness

Must be 49" (125 cm) or less:

22-40 lb (10-18 kg) can sit upright unassisted **CAN** be forward-facing.

40-65 lb (18-30 kg) **MUST** be forward-facing.*

*Check your local and state laws and the AAP/NHTSA recommendations. See page 21 for more information.



1 Important

1-D Before You Begin

Register This Child Restraint

Please fill out the prepaid registration postcard attached to the harness and mail it in today **or register online at www.gracobaby.com/carseatregistration.**

Child restraints could be recalled for safety reasons. You must register this restraint to be reached in a recall. Send your name, address, and the restraint's model number and manufacturing date to:

Graco Children's Products, Inc.
Attn: Customer Service
P.O. Box 169, Elverson, PA 19520-9901
or call 1-800-345-4109
or register online at
www.gracobaby.com/carseatregistration

For recall information, call the U.S. Government's Vehicle Safety Hotline at 1-888-327-4236 (TTY: 1-800-424-9153), or go to <http://www.NHTSA.gov>.

For future reference or if you change addresses, record the model name, model number, date of manufacture and purchase date of this car seat on the below. You can find this information either on the registration card if you still have it or on the date label located on the back of the car seat.

Model Name	_____
Model Number	_____
Date of Manufacture	_____
Date of Purchase	_____

If You Need Help

In the U.S.A, please contact our Customer Service Department with any questions you may have concerning parts, use, or maintenance. When you contact us, please have your product's model number and date of manufacture ready so that we may help you efficiently. These numbers can be found on a sticker on the back side of your car seat.

For additional resources or to get your car seat checked by a child passenger safety technician, please visit the following web sites:

www.nhtsa.gov • www.seatcheck.org • www.safekids.org



1 Important

Certification

This child restraint meets or exceeds all applicable requirements of Federal motor vehicle safety standard 213 for use in motor vehicles.



This child seat is certified for use in aircraft. Use only on forward-facing aircraft seats. Follow the instructions for vehicle installation. For rear-facing installation, see section 3-C and 8-D Lap Belt Installation. For forward-facing installation, see section 4-C and 8-D Lap Belt Installation, but do not use tether.

Contact the airline for their specific policies.

Car Seat's Useful Life

STOP using this car seat and throw it away 7 years after the date of manufacture. Look for this sticker on back of the car seat.

Graco Children's Products Inc. advises against loaning or passing along a car seat unless you know the complete history of the product. We also advise against purchasing a car seat second hand.

Vehicle Seat Protection

Protect vehicle seat. Use a car seat mat, towel, or thin blanket under and behind car seat.



1 Important

Warm Weather Use

Car seat parts can get very hot in the sun or warm weather. **To avoid burns, always check before putting child in car seat.**

1-E Safety Warnings

No car seat can guarantee protection from injury in every situation, but proper use helps reduce the risk of serious injury or death. **READ THIS MANUAL CAREFULLY.**

!WARNING!

Failure to follow these instructions and child restraint's labels can result in child striking the vehicle's interior during a sudden stop or crash.



! NEVER PLACE THIS CHILD RESTRAINT REAR-FACING IN A VEHICLE SEATING LOCATION THAT HAS AN ACTIVE FRONT AIR BAG.

If an air bag inflates, it can hit the child and car seat with great force and cause serious injury or death to your child.

- ! Review your vehicle owner's manual for more information about air bags and car seat use.**
- ! If your vehicle does not have a back seat, review your vehicle owner's manual.**
- ! Choose the correct mode of use for the car seat depending on your child's size. Infants less than 22 lb (10 kg) MUST use this car seat rear-facing.**



1 Important

! Children are safer riding rear-facing and should ride rear-facing as long as possible, until they reach the maximum rear-facing height or weight rating for their car seat. Then children should ride forward-facing, using the built-in harness system for as long as possible until they reach the maximum forward-facing weight or height for their car seat. Be sure to check your local and state laws, as well AAP and NHTSA recommendations, for car seat usage.*

! Select a suitable location for the car seat in your vehicle.

! Secure car seat with a vehicle seat belt or lower anchor attachment that is properly routed as shown in this manual.

* Graco supports the American Academy of Pediatrics and National Highway Traffic Safety Administration's Car Seat Guidelines. Visit www.gracobaby.com/en-US/safety for information on car seat usage recommendations.



1 Important

- ! Vehicle seat belt system MUST hold car seat securely. Not all vehicle seat belts can be used with a car seat.**
- ! If vehicle seat belt does not hold car seat securely, read “Vehicle Seat Belts” section 8-D and your vehicle owner’s manual.**
- ! Always secure car seat with lower anchor attachment or a vehicle seat belt, even when unoccupied. In a crash, an unsecured car seat can injure passengers.**
- ! If car seat is in a crash, it must be replaced. DO NOT use it again! A crash can cause unseen damage and using it again could result in serious injury or death.**
- ! DO NOT use car seat if it is damaged or missing parts.**
- ! DO NOT use accessories or parts other than those provided by Graco except for a thin towel or mat to protect your vehicle seat or rolled towels or pool noodles to help get your car seat level. Their use could alter the performance of the car seat.**



1 Important

! DO NOT remove LATCH system from car seat. If using vehicle seat belt to secure car seat, lower anchor connectors must be stored.

! Never leave child unattended, even when sleeping. Child may become tangled in harness straps and suffocate or strangle.

! Rear-facing car seat must be properly leveled:

- Too reclined can result in injury or ejection.
- Too upright can result in breathing difficulties.



! Never attach two lower anchor connectors to one vehicle lower anchor point unless specifically allowed by the vehicle manufacturer.

! Do not use both the vehicle belt and lower anchor attachment at the same time when using the car seat rear or forward facing.

2-A Car Seat Features



2 Features

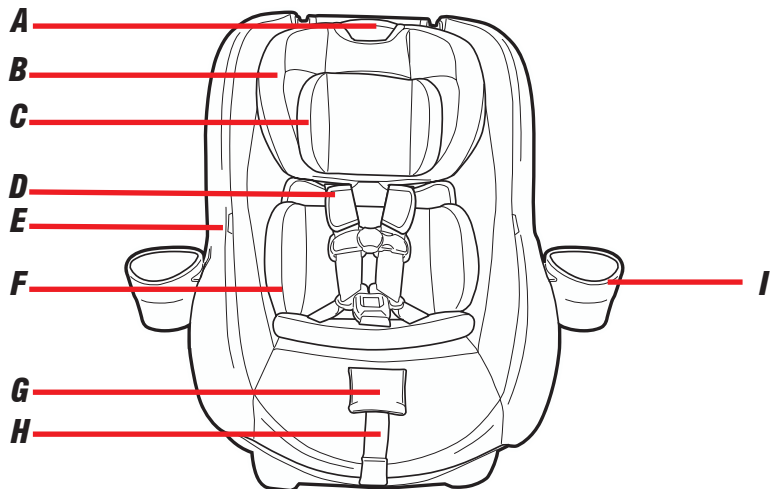

A Headrest/Harness Height Adjustment Handle

B Headrest

C Infant Head Support

D Harness Covers

E Buckle Tongue Storage
(Fuss Free Harness)

F Infant Body Support

G Harness Adjustment Lever (under flap)

H Harness Adjustment Strap

I Cup Holders

J Harness Straps

K Chest Clip

L Buckle Tongues

M Buckle

N Buckle Strap

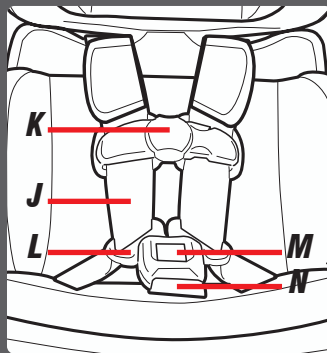

2 Features



2 Features

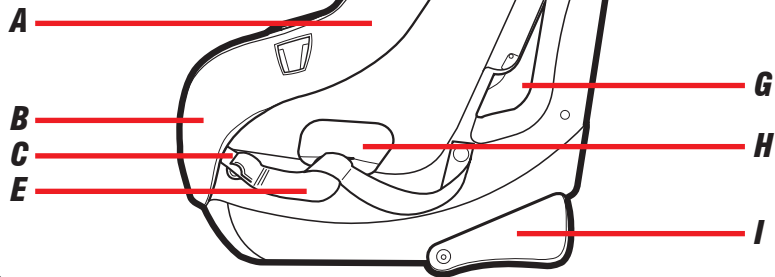
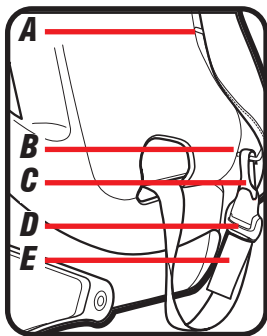

- A Forward-Facing Lower Anchor Connector Storage Bar**
- B Rear-Facing Lower Anchor Connector Storage Bar**
- C Lower Anchor Connector**
- D Lower Anchor Adjuster**
- E Lower Anchor Strap**
(Stored)
- F Level Indicator**
- G Forward-Facing Belt Path**
- H Rear-Facing Belt Path**
- I Recline Foot**



2 Features



2 Features

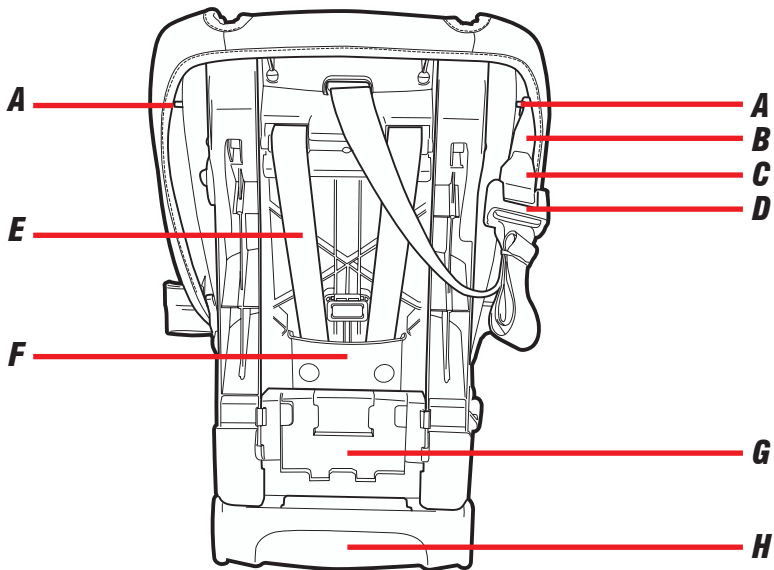

- A Tether Storage Bars**
- B Tether Hook**
- C Tether Strap**
- D Tether Strap Adjuster**
- E Harness Straps**
- F Harness Cover Plate**
- G Instruction Manual Storage**
- H Recline Foot**
- I Splitter Plate**
(Under Seat)

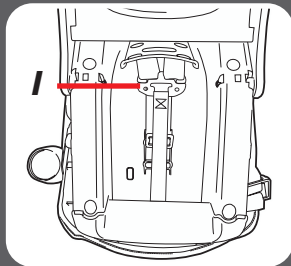

Bottom of Seat



2 Features

3-A Rear-Facing Use

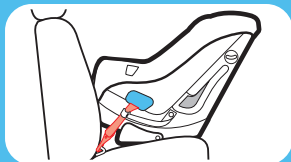

Lower Anchor Attachment

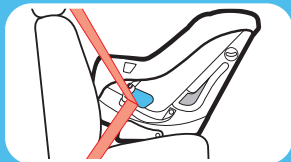

**Vehicle Seat Lap/
Shoulder Belt**

Visit www.gracobaby.com and the Graco® Contender™ GO Convertible Car Seat product page to view installation videos.

Rear-Facing:
5-40 lb (2.2-18 kg) and whose top of head is at least 1 inch (2.5 cm) below the headrest adjustment handle

- Infants who weigh less than 22 lb (10 kg) **MUST be rear-facing.**
- Place car seat rear-facing in the vehicle back seat.
- Make sure lower anchor strap or vehicle seat belt is routed through the rear-facing belt path marked with a blue label.
- Install this car seat tightly in your vehicle. Car seat **should not move** at the rear-facing belt path more than 1 inch (2.5 cm) from side to side, front to back.
- Check recline level making sure the ball is within the blue area. Vehicle **MUST** be on level ground.



- Harness straps need to be **at or just below** the top of child's shoulders and chest clip is at **armpit level**.
- Recheck the level indicator with child in seat.
- Children are safer riding rear-facing and should ride rear-facing as long as possible, until they reach maximum rear-facing height or weight rating for their car seat. Then children should ride forward-facing, using the built-in harness system for as long as possible until they reach the maximum forward-facing weight or height for their car seat. Be sure to check local and state laws, as well as AAP and NHTSA recommendations, for car seat usage.

⚠ WARNING!



NEVER place this child restraint rear-facing in a vehicle seating location that has an active front air bag.

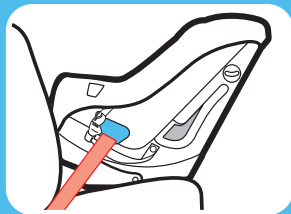

Vehicle Seat Lap Belt



3-A Rear Facing



3-A Rear Facing

When reading the level indicator,

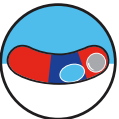
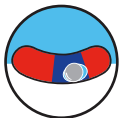

Vehicle **MUST** be on level ground.

Use corrected age for preemies.

- If the ball is entirely in the light blue area, the restraint is level for infants 0+ months in age.
- If the ball is entirely in the dark blue area, the restraint is level for a child 3+ months in age.
- If the ball is not completely in the blue areas, the child restraint is **NOT** level. You must adjust your recline.
- If needed, rolled towels may be placed under the car seat at the vehicle seat crease, until the ball is completely in the blue area.

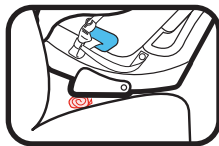

3-B Install Rear-Facing with Lower Anchor Attachment

Review your vehicle owner's manual for lower anchor location and use.

1. Store Tether Strap

Attach tether hook to the plastic bar on either side of the car seat at the top of the seat.

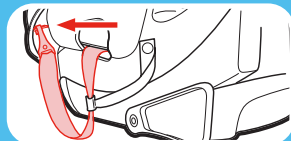
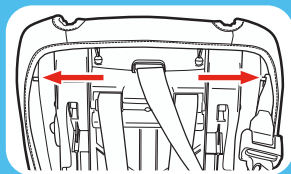

2. Remove Lower Anchor Connectors from Storage Location

Visit www.gracobaby.com and the Graco® Contender™ GO Convertible Car Seat product page to view installation videos.

3-B Rear Facing with Lower Anchor Attachment

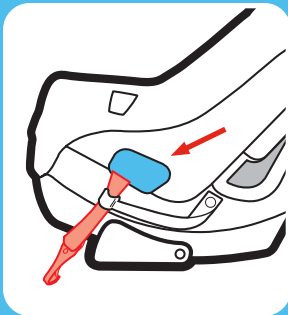
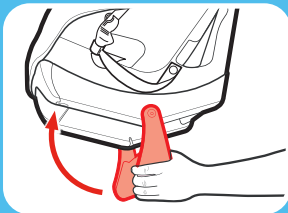

3. Make Sure Lower Anchor Strap is in the Rear-Facing Belt Path Marked With a Blue Label

To move the lower anchor attachment, review section 7.

4. Recline the Car Seat

Flip the recline foot to the rear-facing position as shown.

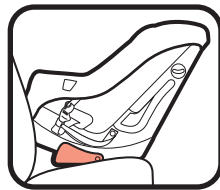

5. Place Car Seat Rear-Facing in Back Seat of the Vehicle

Place rear-facing in vehicle seat and center the car seat between the lower anchors. The bottom of the car seat should sit as flat as possible on the vehicle seat.

6. Make Sure Bottom of Seat is a minimum of 80% on Vehicle Seat



7. Extend the Lower Anchor Strap

For easier installation, extend the lower anchor strap to its maximum length by pressing the grey button and pulling on the strap.

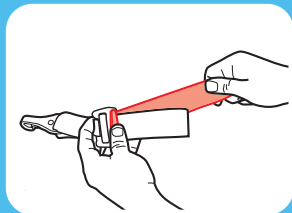
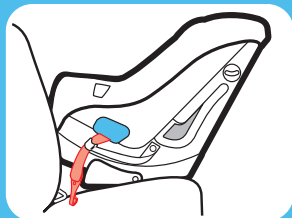

3-B

**Rear Facing
with Lower Anchor
Attachment**

3-B Rear Facing with Lower Anchor Attachment

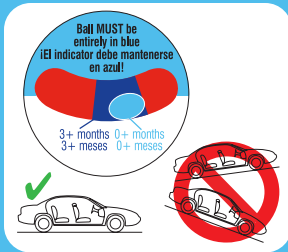
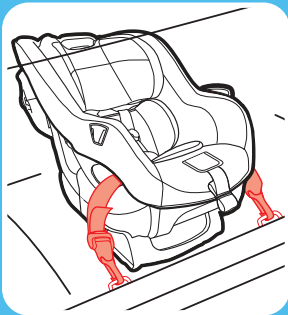

8. Check the Level Indicator

Vehicle **MUST** be on level ground. Ball **must be completely in the blue area**. Readjust if needed.

For infants 3 months and under, the **ball must be entirely in the light blue area**.

If needed, rolled towels may be placed under the car seat at the vehicle seat crease, until the ball is completely in the blue area.

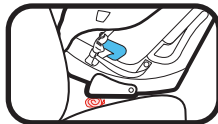

9. Attach Lower Anchor Connectors to Vehicle's Lower Anchors

Lower anchor strap should lie flat and not be twisted.

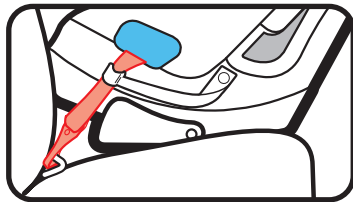

10. Tighten the Lower Anchor Strap

Press down firmly in the center of the car seat while tightening the lower anchor strap.

Note: You may need to tighten through the rear-facing belt path to get a tight fit. To expose the belt path, unsnap the bottom cover on each side and pull the seat pad forward out of the way.

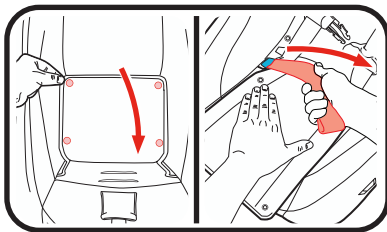

11. Test For Tightness

Grab the sides of the seat where the lower anchor strap is and slide the car seat side-to-side and front-to-back.

If the seat moves less than 1 inch (2.5 cm), it is tight enough.

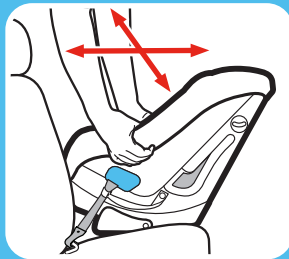
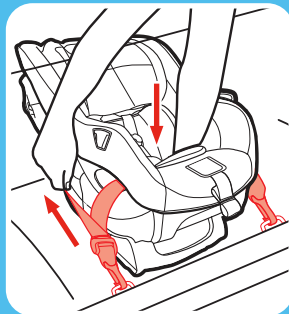

3-B
Rear Facing
with Lower Anchor
Attachment

3-B Rear Facing with Lower Anchor Attachment

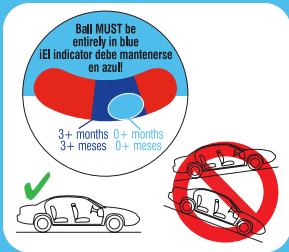
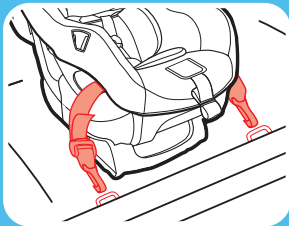

12. Check the Level Indicator

Vehicle **MUST** be on level ground. Ball **must be completely in the blue area**. Readjust if needed.

For infants 3 months and under, the **ball must be entirely in the light blue area**.

If needed, rolled towels may be placed under the car seat at the vehicle seat crease, until the ball is completely in the blue area.

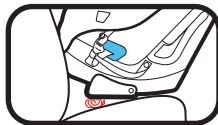

See section 5-A to secure your child.

Recheck the level indicator with child in seat.

13. To Remove Lower Anchor Strap From Vehicle

See section 8-A.

Is Everything Correct?

Car Seat Does Not Move More than 1 inch (2.5 cm) at the Belt Path

Level Indicator's Ball in the Blue Area and Vehicle on Level Ground

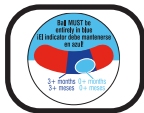

Harness Straps at or Just Below the Child's Shoulders.

Review section 5

Chest Clip Even With Armpits

Review section 5

Cannot Pinch Harness Straps at the Shoulder

Review section 5

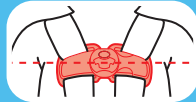
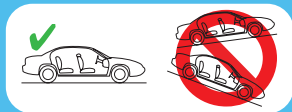

3-B
Rear Facing
with Lower Anchor
Attachment

3-C Installing Rear-Facing with Vehicle Seat Belt

See section 8-D for additional vehicle seat belt installation information.

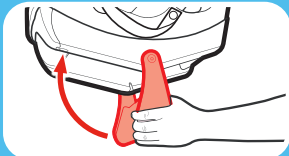
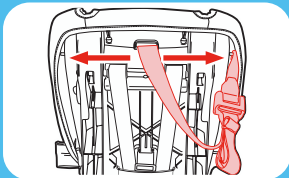

Visit www.gracobaby.com and the Graco® Contender™ GO Convertible Car Seat product page to view installation videos.

1. Store Tether Strap and Lower Anchor Strap

Attach tether hook to the plastic bar on either side of the car seat at the top of the seat. Attach the lower anchor connectors to the plastic bars on the sides of the seat.

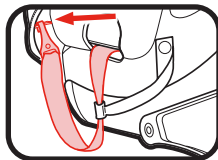

2. Recline the Car Seat

Flip the recline foot to the rear-facing position as shown.

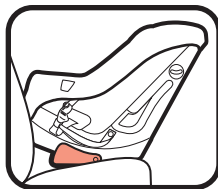

3. Place Car Seat Rear-Facing in Back Seat of the Vehicle

Place rear-facing in vehicle seat. The bottom of the car seat should sit as flat as possible on the vehicle seat.

4. Make Sure Bottom of Seat is a minimum of 80% on Vehicle Seat



5. Check the Level Indicator

Vehicle **MUST** be on level ground. Ball **must be completely in the blue area**. Readjust if needed.

For infants 3 months and under, the **ball must be entirely in the light blue area**.

If needed, rolled towels may be placed under the car seat at the vehicle seat crease, until the ball is completely in the blue area.

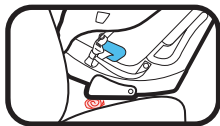

41

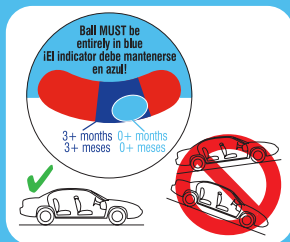
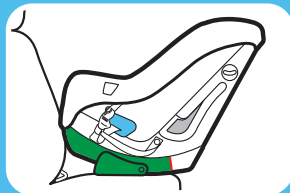
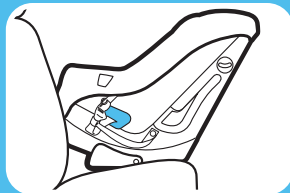



3-C Rear Facing
with Seat Belt

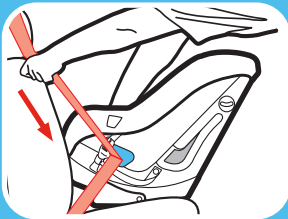
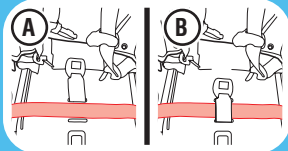
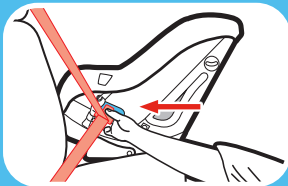

3-C Rear Facing with Seat Belt

Review your vehicle owner's manual for vehicle seat belt use



6. Route the Vehicle Seat Belt

Thread vehicle seat belt through the rear-facing belt path (marked with a blue label) and out the other side. Buckle the seat belt. The seat belt should lie as flat as possible and not be twisted.

Note: It may be easier to route the vehicle seat belt by lifting seat pad up to expose the belt path.

Make sure the vehicle seat belt is in front of the buckle strap when the buckle is in the inner-most position (A), and behind when in the outer-most position (B).

7. Lock Vehicle Seat Belt

In most vehicles today, slowly pull the shoulder belt all the way out and then let it go back in. You will hear a clicking sound. Slowly pull out on the belt and it should be locked. If not, review your vehicle owner's manual and section 8-D.

8. Tighten the Vehicle Seat Belt

Press down firmly in the center of the car seat. Pull on the shoulder belt to tighten while feeding the slack back in the retractor.

9. Test For Tightness

Grab the sides of the seat where the vehicle seat belt is and slide the car seat side-to-side and front-to-back.

If the seat moves less than 1 inch (2.5 cm), it is tight enough.

10. Check the Level Indicator

Vehicle **MUST** be on level ground. Ball **must be completely in the blue area**. Readjust if needed.

For infants 3 months and under, the **ball must be entirely in the light blue area**.

If needed, rolled towels may be placed under the car seat at the vehicle seat crease, until the ball is completely in the blue area.

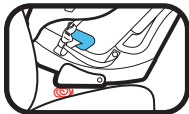

See section 5-A to secure your child.

Recheck the level indicator with child in seat.

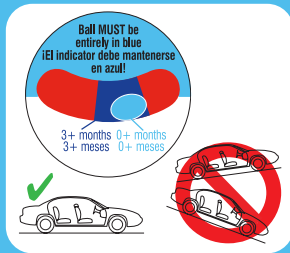
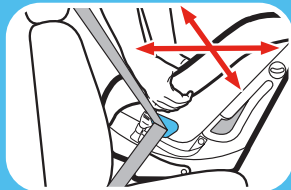
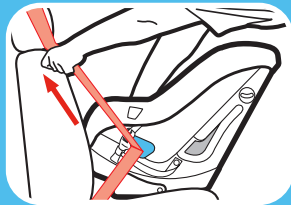

3-C Rear Facing
with Seat Belt

Is Everything Correct?

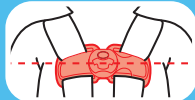
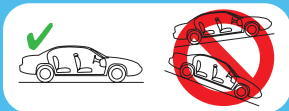

Car Seat Does Not Move More than 1 inch (2.5 cm) at the Belt Path

Level Indicator's Ball in the Blue Area and Vehicle on Level Ground

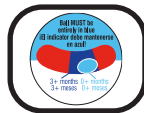

Harness Straps at or Just Below the Child's Shoulders

Review section 5

Chest Clip Even With Armpits

Review section 5

Cannot Pinch Harness Straps at the Shoulder

Review section 5

4-A Forward-Facing Use

Forward-Facing:

22-65 lb (10-30 kg) 49" (125 cm) or less

- When forward-facing, harness covers **MUST be used** for children weighing 25 lb (11 kg) or less.
- Harness covers **MUST be placed on top** of child's shoulders.
- Place car seat forward-facing in the vehicle back seat.
- Make sure lower anchor strap or vehicle seat belt is routed through the forward-facing belt path marked with an orange label.
- Install this car seat tightly in your vehicle. Car seat **should not move** at the forward-facing belt path more than 1 inch (2.5 cm) from side to side, front to back.



LATCH

Do not install by this method for a child weighing more than 45 lb (20 kg)

Visit www.gracobaby.com and the Graco® Contender™ GO Convertible Car Seat product page to view installation videos.



4-A Forward-Facing

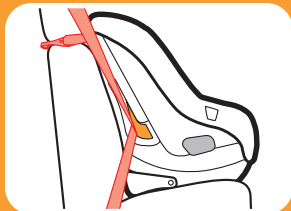

Vehicle Lap/Shoulder Seat Belt with Tether



Vehicle Seat Lap Belt with Tether

- Harness straps need to be **at or just above** the top of child's shoulders and chest clip is at **armpit level**.
- Children are safer riding rear-facing and should ride rear-facing as long as possible, until they reach the maximum rear-facing height or weight rating for their car seat. Then children should ride forward-facing, using the built-in harness system for as long as possible until they reach the maximum forward-facing weight or height rating for their car seat. Be sure to check your local and state laws, as well as AAP and NHTSA recommendations, for car seat usage.

4-B Install Forward-Facing with LATCH

Review your vehicle owner's manual for LATCH location and use. Do not install by this method for a child weighing more than 45 lb (20 kg).

Visit www.gracobaby.com and the Graco® Contender™ GO Convertible Car Seat product page to view installation videos.

- 1. Remove Lower Anchor Connectors from Storage Location**
- 2. Make Sure Lower Anchor Strap is in the Forward-Facing Belt Path Marked with Orange Label**

To move the lower anchor strap, review section 7.

- 3. Adjust Child Restraint to Upright Position**

Flip recline foot to the forward-facing position as shown.



47

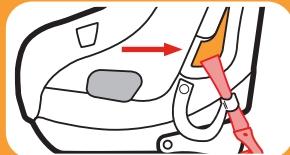
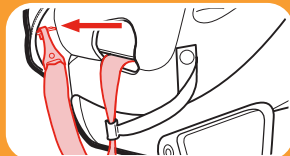

Forward-Facing
with LATCH
4-B

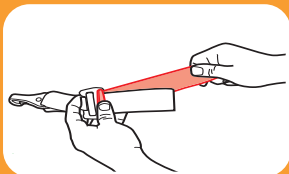
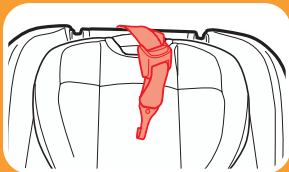
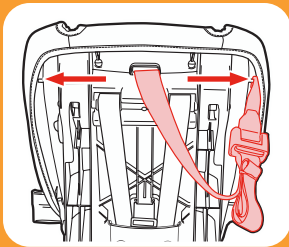

4. Remove Tether Strap from Storage Location

Unhook tether and lay it in the seat.

5. Extend the Lower Anchor Strap.

For easier installation, extend the lower anchor strap to its maximum length by pressing the grey button and pull out on the strap.

6. Place Car Seat Forward-Facing in Back Seat of the Vehicle

Place forward-facing in vehicle seat. The bottom of the seat should sit as flat as possible on the vehicle seat.

7. Make Sure Bottom of Seat is a minimum of 80% on Vehicle Seat



8. Attach Lower Anchor Connectors to Vehicle's Lower Anchors.

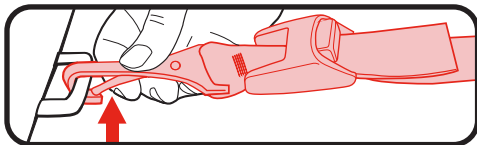

Lower anchor strap should lie flat and not be twisted.

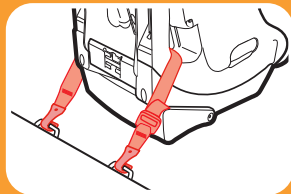

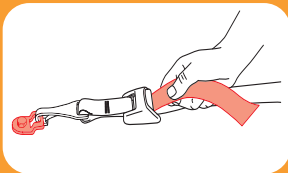
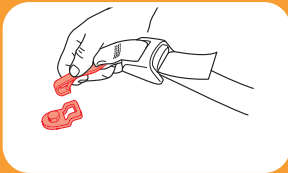
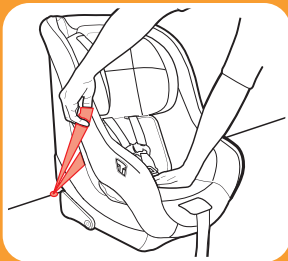

Forward-Facing
with LATCH



9. Tighten the Lower Anchor Strap

Press down firmly in the center of the car seat while tightening the lower anchor strap

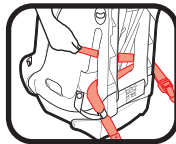
You may need to tighten through the forward-facing belt path from the other side of the seat to get a tight fit.



10. Attach Tether Strap

Extend the tether strap pressing the grey button and pulling out on the strap and attach to the tether anchor point.

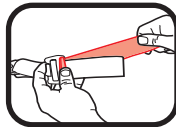

Consult vehicle owner's manual for specific location.

11. Tighten Tether Strap

Remove all the slack. Tether strap should lie flat and not be twisted.

12. Test For Tightness

Grab the sides of the seat where the lower anchor strap is and slide the car seat side-to-side and front-to-back.

If the seat moves less than 1 inch (2.5 cm), it is tight enough.

See section 5-A to secure your child.

13. To Remove Lower Anchor Strap From Vehicle

See section 8-A.

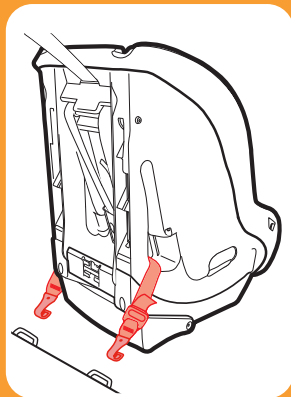

4-B
Forward-Facing
with LATCH



4-B Forward-Facing with LATCH

Is Everything Correct?

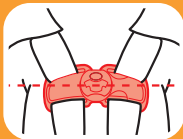

Car Seat Does Not Move More than 1 inch (2.5 cm) at the Belt Path

Harness Straps at or Just Above the Child's Shoulders

Review section 5

Chest Clip Even With Armpits

Review section 5

Cannot Pinch Harness Straps at the Shoulder

Review section 5



4-C Install Forward-Facing with Vehicle Seat Belt

See section 8-D for additional vehicle seat belt installation information.

Visit www.gracobaby.com and the Graco® Contender™ GO Convertible Car Seat product page to view installation videos.

1. Store Lower Anchor Connectors in Storage Location

Attach lower anchor connectors to the plastic bars as shown.

2. Adjust Child Restraint to Upright Position

Flip recline foot to the forward-facing position as shown.

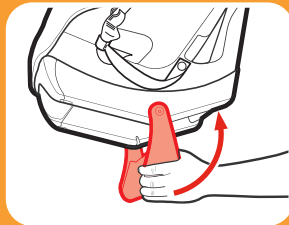
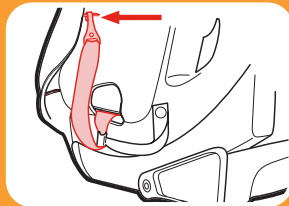
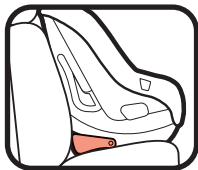

4-C Forward-Facing with Seat Belt

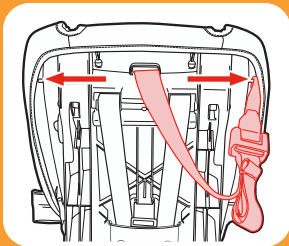

3. **Unhook Tether Strap From Storage**

Unhook tether and lay it on the seat.

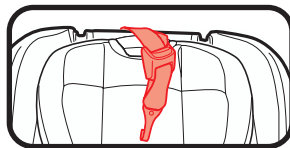

4. **Place Car Seat Forward-Facing in Back Seat of the Vehicle**

Place forward-facing in vehicle seat. The bottom of the seat should sit as flat as possible on the vehicle seat.

5. **Make Sure Bottom of Seat is a minimum of 80% on Vehicle Seat**





4-C Forward-Facing with Seat Belt

Review your vehicle owner's manual for vehicle seat belt use

6. Route the Vehicle Seat Belt

Thread vehicle seat belt through the forward-facing belt path (marked with an orange label) and out the other side. Buckle the seat belt. The seat belt should lie as flat as possible and not be twisted.



7. Lock the Vehicle Seat Belt

In most vehicles today, slowly pull the shoulder belt all the way out and then let it go back in. You will hear a clicking sound. Slowly pull out on the belt and it should be locked. If not, review your vehicle owner's manual and section 8-D.



4-C Forward-Facing with Seat Belt

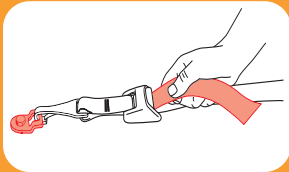
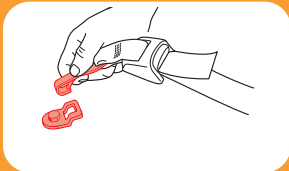

8. Tighten the Vehicle Seat Belt

Press down firmly in the center of the car seat. Pull on the shoulder belt to tighten while feeding the slack back in the retractor.

9. Attach Tether Strap

Extend the tether strap pressing the grey button and pulling out on the strap and attach to the tether anchor point.

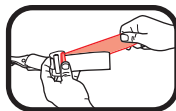

Consult vehicle owner's manual for specific location.

10. Tighten the Tether Strap

Remove all the slack. Tether strap should lie flat and not be twisted.

11. Test For Tightness

Grab the sides of the seat where the vehicle seat belt is and slide the car seat side-to-side and front-to-back.

If the seat moves less than 1 inch (2.5 cm), it is tight enough.

See section 5-A to secure your child.



4-C Forward-Facing
with Seat Belt

Is Everything Correct?

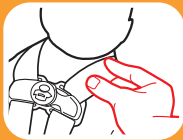
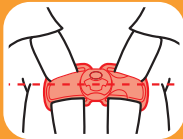

Car Seat Does Not Move More than 1 inch (2.5 cm) at the Belt Path

Harness Straps at or Just Above the Child's Shoulders

Review section 5

Chest Clip Even With Armpits

Review section 5

Cannot Pinch Harness Straps at the Shoulder

Review section 5

!WARNING!

WARNING! In cold weather, do not put snowsuits or bulky garments on your child when placing them in the car seat. Bulky clothing can prevent the harness straps from being tightened properly. To keep child warm, buckle your child in the car seat and place a blanket around the child or place the child's coat on backwards after buckling in.



5-A Securing Child 5-Point Harness

1. Loosen Harness Straps

Push down on the harness adjustment lever while pulling out on the harness straps at the chest clip (A). Unbuckle the chest clip (B) and the buckle (C). Place harness straps off to the sides.

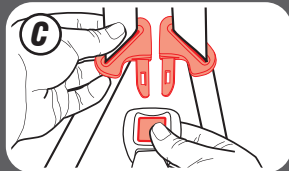
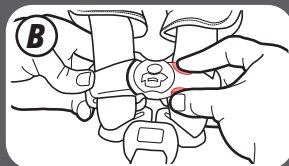
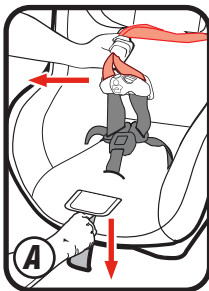

5-A Securing Child 5-Point Harness

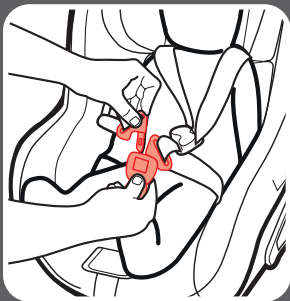

2. Place Your Child in the Seat

Make sure their back is flat against the car seat back.

3. Place Harness Straps Over Child's Shoulders and Buckle

You will hear a “click” when buckle tongues are securely attached. Pull up on each buckle tongue to make sure it is securely attached.

4. Be Sure the Harness Straps Are at the Proper Height

Rear-Facing: Harness straps must be **at or just below** the child's shoulders. Top of head **MUST** be at least 1 inch (2.5 cm) below the headrest/harness height adjustment handle.

Forward-Facing: Harness straps must be **at or just above** the child's shoulders. Top of child's ears must be **below** top of headrest.

Remove the infant head and body supports.

To Raise or Lower Headrest/Harness Height

Squeeze the adjustment handle and move headrest for the proper harness height.

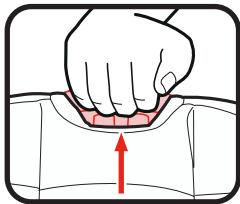

Rear-Facing



Forward-Facing

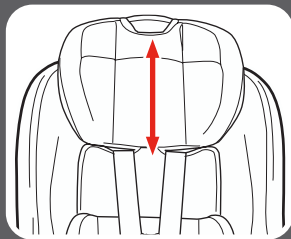

5-A Securing Child
5-Point Harness

5-A Securing Child 5-Point Harness

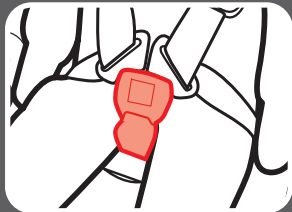
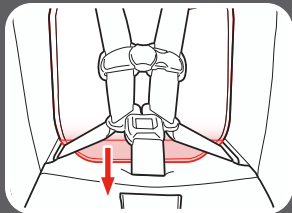

When headrest is in lowest position, always pull flap forward as shown.

5. **Check the Buckle Position**

The correct slot is the one that is closest to your child without being underneath them.

6. **To Adjust Buckle Strap**

(skip to step 10 if not needed)

To adjust, recline foot must be in forward-facing position. Locate the metal retainer under the car seat.

7. Rotate Metal Retainer and Insert It Up Through the Shell and Pad

From the top of the car seat, pull the buckle out.

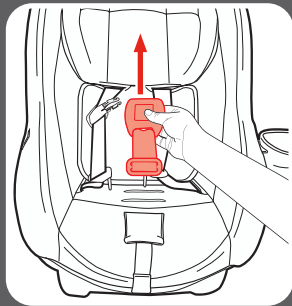
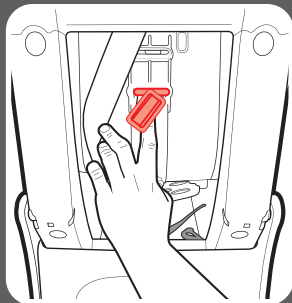

5-A Securing Child 5-Point Harness

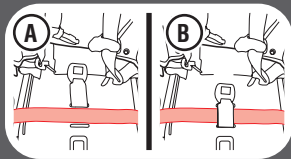
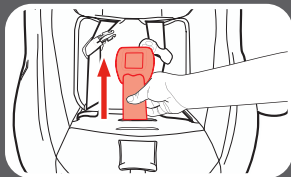
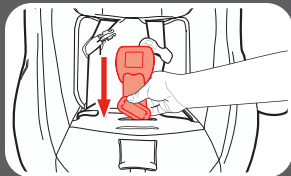

8. Insert Metal Retainer in the New Buckle Strap Slot

Reach underneath the car seat and pull the metal retainer through.

9. Pull Up on Buckle Strap to Make Sure it is Secured

Rear-Facing: Make sure the lower anchor strap is in front of the buckle strap when the buckle is in the inner-most position **(A)**, and behind when in the outer-most position **(B)**, and that it is flat and not twisted.

10. Buckle the Chest Clip

You will hear a “CLICK” when the chest clip is securely buckled.

11. Pull All the Slack Out From Around the Waist

Pull up on the harness strap while pushing the chest clip down. Do this to both sides.

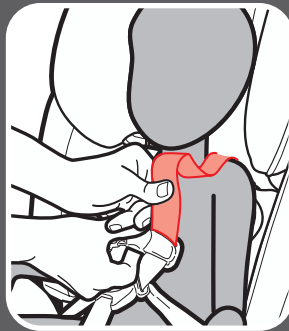
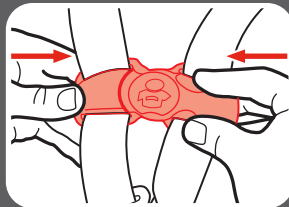

5-A Securing Child
5-Point Harness

5-A Securing Child 5-Point Harness

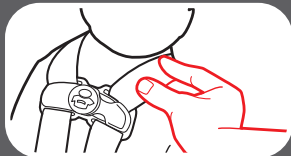
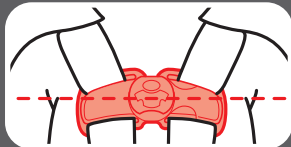
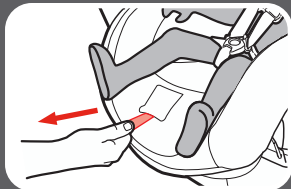

12. Tighten the Harness by Pulling the Harness Adjustment Strap

A snug harness should not allow any slack. It lies in a relatively straight line without sagging. It does not press on the child's flesh or push the child's body into an unnatural position.

When you are not able to pinch any of the harness webbing at your child's shoulder, the harness is tight enough.

13. Raise the Chest Clip to Child's Armpit Level

14. Check Tightness Again, Tighten More if Needed

6-A Accessories

Cup Holders (optional)

Slide the cup holder down the guide until it locks into place.

To remove, place both hands under the cup holder and push up on the cup holder.

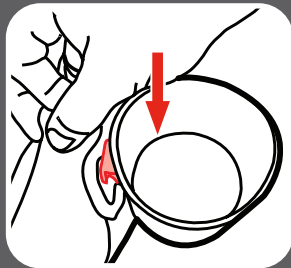

Infant Body Support

Use body support only in the rear-facing mode.

Body support must be used if shoulders are below the lowest harness setting.

Never allow body support to bunch or fold behind child.

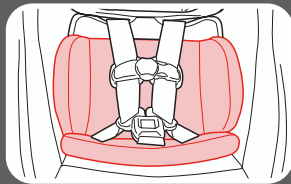



6 Accessories

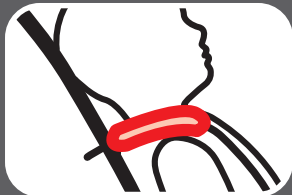
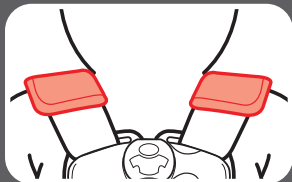
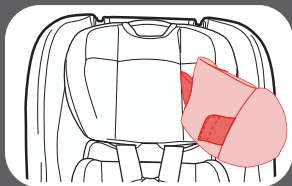

Infant Head Support

Use head support only in the rear-facing mode.

To adjust the support, pull up until desired height.

To install, thread the head support straps through the headrest and use the fastening strips to connect the straps together.

To remove, undo the fastening strips and pull the straps out of the headrest.

Harness Covers

Make sure that harness covers do not interfere with placement of the chest clip at armpit level.

When forward-facing, harness covers **MUST be used** for children weighing 25 lb (11 kg) or less.

When forward-facing, harness covers **MUST be placed on top** of child's shoulders.

To remove, undo the fastening strips and remove.

7-A Moving the Lower Anchor Attachment

1. For Ease of Moving the Lower Anchor Attachment

- A. Unhook the lower anchor connectors from the storage location.
- B. Unclip the seat pad from the front of the child restraint.
- C. Pull the lower anchor strap out of the belt path opening, so that both lower anchor connectors are on the same side.

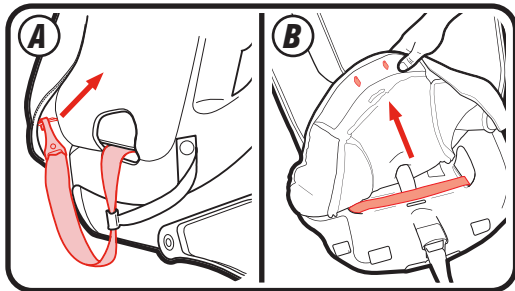

69

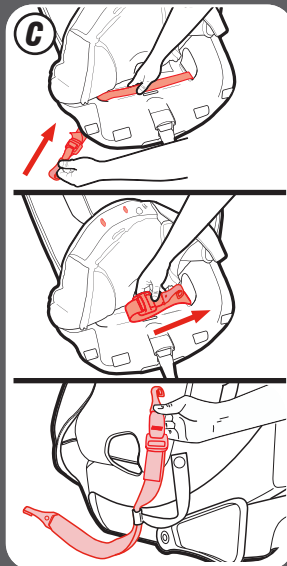

7 Moving Lower Anchor Attachment

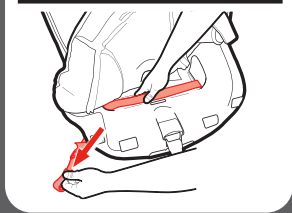
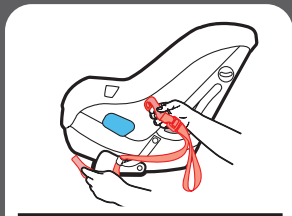
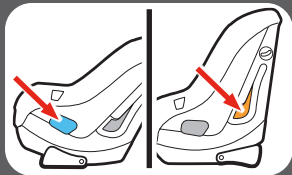

2. Select the Correct Belt Path Opening

Rear-Facing: Use the belt path marked with a blue label.

Forward-Facing: Use the belt path marked with an orange label.

3. Feed the Lower Anchor Connector with the Adjuster Closest to it Through the Chosen Belt Path

Rear-Facing: Make sure lower anchor strap is in front of the buckle strap when the buckle is in the inner-most position (A), and behind when in the outer-most position (B). Make sure the strap is flat and is not twisted.

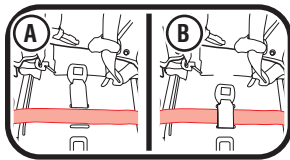

Forward-Facing: Make sure the strap is flat and not twisted.

4. Replace the Seat Pad Fabric on the Front of the Child Restraint

Pull the harness adjustment strap through pad. Replace the seat pad.

Snap the button clips back into place.

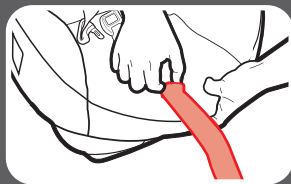
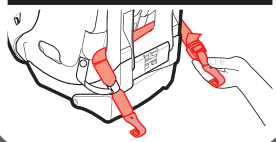
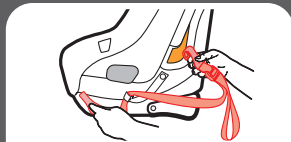

8-A How to Uninstall Lower Anchor Connectors and Tether

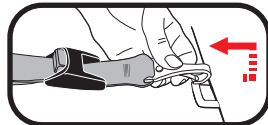
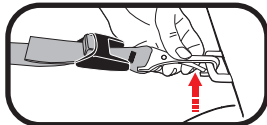
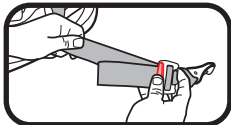

Lower Anchor Connectors

Push gray button in while pulling on lower anchor strap to loosen. Press in on the hook's spring. Push hook in, lift hook up, twist and pull out away from anchor point.

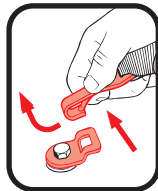
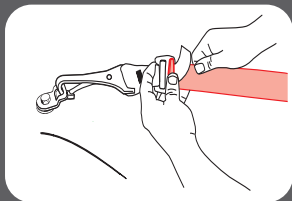

Tether Strap

To remove, press the grey button and pull out on the strap to release the tension. Press in on the hook's spring. Push tether hook in, then lift up and pull away from tether anchor.

8-B Choosing Vehicle Seat Location

Review your vehicle owner's manual for seating locations.

The best seating location for this car seat is one that:

- Is recommended by your vehicle owner's manual, and
- Results in a secure installation of this car seat

In the event there is no available back seat and / or you have no other option than to place a child in a front passenger seating position (other than rear-facing), the National Highway Traffic Safety Administration (NHTSA) recommends that you take the following steps:

- Ensure the child is properly restrained according to their age and size
- Move the seat as far back as possible
- Make sure the child is not leaning out of position, such as leaning forward into the deployment path of the air bag
- Set the air bag ON-OFF switch, if available, to the OFF position



8-C Unsafe Vehicle Seat Locations

Never install this car seat in any of the following vehicle seating locations:



Rear-facing or side-facing vehicle seats



Rear-facing with an active front air bag

8-D Vehicle Seat Belts

Review your vehicle owner's manual for vehicle seat belt use

This car seat can be installed using a vehicle seat belt. To do this, you will need to change the seat belt to a locked mode for use with car seats. With some vehicle seat belts, this is done with the latchplate; with other vehicle seat belts, this is done with the retractor.

Vehicle Seat Belt Terms

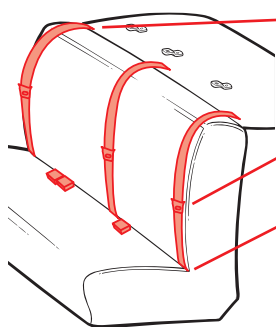

Retractor

A device that winds up the unused vehicle seat belt. It is often hidden inside the panels on the walls of the vehicle or in the vehicle seatback.

Latch Plate

The male end of the seat belt with the silver tongue.

Seat Bight

The crease where the vehicle seat back and seat bottom meet.

Identify Your Seat Belt Type

There are two different types of vehicle seat belts that can be used with this car seat:



Lap/Shoulder Belt

3 connection points. Can be used in all car seats modes of use.

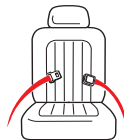

Lap Belt Only

2 connection points. **Can ONLY be used in harness mode.**

The following types of vehicle seat belts **CANNOT** be used safely with this car seat:



Lap Belt with Motorized Shoulder Belt



Lap Belt or Shoulder Belt Mounted on Door

Belts Forward of the Seat Bight



Some vehicles you may not get a secure fit. Read both your vehicle and car seat manuals.

Lap/Shoulder Belt Installation - Rear-Facing/Forward Facing Modes

Always review your vehicle owner's manual for specific information about your vehicle seat belts.

There are three types of retractors: **ELR (Emergency Locking Retractor)**, **ALR (Automatic Locking Retractor)**, and **Switchable (ELR switch to ALR)**. To determine your type of retractor, follow these steps:

1. **Slowly** pull the belt out about halfway and stop.
2. Let the belt retract back several inches.
3. Try to **slowly** pull the belt out more. If the belt cannot be pulled any further, it is **ALR**. If it can be pulled further, go to the next step.
4. **Slowly** pull the belt all the way out, and then allow it to retract several inches.
5. Try to pull the belt all the way out again. If it cannot be pulled out, it is **Switchable**. If it can still be pulled out freely, it is **ELR**.

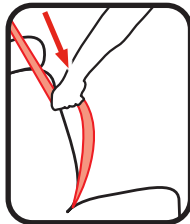

Note: Most vehicles manufactured after 1996 will have Switchable retractors in the back seat. If you have any questions about your retractor type, consult your vehicle owner's manual or call Graco for assistance.



How to Lock Your Lap and Shoulder Vehicle Seat Belt

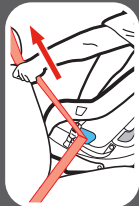
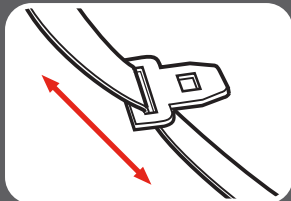

Sliding Latch Plate and Switchable Retractor

A latchplate that slides freely on the belt webbing and cannot, by itself, hold the belt snug around a car seat.

When installing the car seat, route the vehicle seat belt through the proper belt path and buckle it in.

Slowly pull the shoulder belt all the way out to switch it to locking mode. Then, as you pull the vehicle seat belt tight, feed all the slack back into the retractor.

Grab the sides of the seat at the belt path and slide the seat side-to-side and front-to-back. The seat should not move more than 1 inch (2.5 cm).

Note: With the vehicle seat belt in this locking mode, all the tension is upwards in the shoulder belt. This may start to tilt your car seat sideways. If this happens, use a locking clip instead of this switching the retractor. See Sliding Latch Plate and ELR Retractor.

Locking Latchplate and ELR Retractor

A latchplate that holds the lap belt snug after it has been adjusted; contains a metal bar on the underside of the hardware that “locks” the belt in position.

When installing the car seat, route the vehicle seat belt through the proper belt path and buckle it in. Then, pull upwards on the shoulder belt so that the lap belt gets tight around the car seat.

Grab the sides of the seat at the belt path and slide the seat side-to-side and front-to-back. The seat should not move more than 1 inch (2.5 cm).

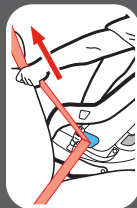
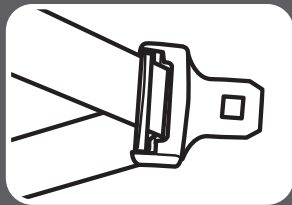

8

**Vehicle
Information**

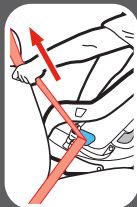
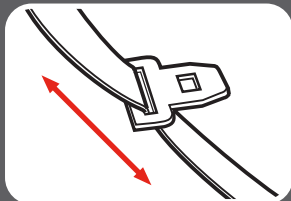

Sliding Latch Plate and ALR Retractor

A latchplate that slides freely on the belt webbing and cannot, by itself, hold the belt snug around a car seat.

Slowly pull the shoulder belt all the way out.

Route the vehicle seat belt through the proper belt path and buckle it in. Then, as you pull the vehicle seat belt tight, feed all the slack back into the retractor.

Grab the sides of the seat at the belt path and slide the seat side-to-side and front-to-back. The seat should not move more than 1 inch (2.5 cm).

Sliding Latch Plate and ELR Retractor

A latchplate that slides freely on the belt webbing and cannot, by itself, hold the belt snug around a car seat.

With this retractor, you will need to use the locking clip to lock the vehicle seat belt.

To obtain a locking clip call 1-800-345-4109.

Route the vehicle seat belt through the proper belt path and buckle it in. Pull the vehicle seat belt tight. While pushing down on seat, pinch the two straps together behind the buckle tongue. Unbuckle the belt without allowing it to slip.

Attach locking clip to lap and shoulder belts as shown.

Rebuckle belt. Check that lap belt does not move by pulling hard. If belt loosens or lengthens, repeat procedure.

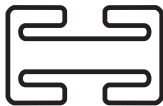

Locking Clip

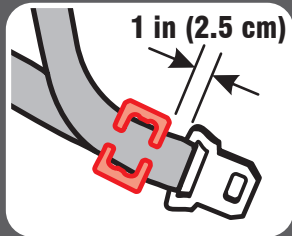

8

**Vehicle
Information**

Lap Belt Installation

Always review your vehicle owner's manual for specific information about your vehicle seat belts.



Grab the sides of the seat at the belt path and slide the seat side-to-side and front-to-back. The seat should not move more than 1 inch (2.5 cm).



Locking Latch Plate and No Retractor

When installing the car seat, route the lap seat belt through the proper path and buckle it in. Then, pull upwards on the tail of the belt so that the lap belt gets tight around the car seat.

Sewn On Latch Plate and ALR

Slowly pull the lap belt all the way out. Route the vehicle seat lap belt through the proper belt path and buckle it in. Then, pull the lap belt tight while feeding all the slack back into the retractor.

9-A Cleaning Seat Pad

Refer to seat pad care tag for washing instructions.

Headrest Pad

Clean with a damp sponge using mild soap and cool water. If needed, pad may be removed for cleaning.

Raise the headrest to the highest position.

Undo elastic loops on back of headrest.

Remove the headrest pad.

Machine wash pad in cold water on delicate cycle and drip-dry. **DO NOT USE BLEACH.**

Reverse the steps to reattach the pad on the headrest.

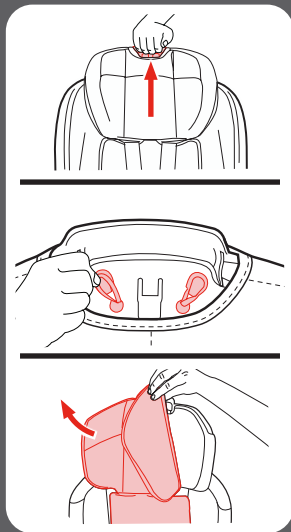

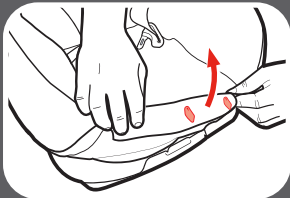
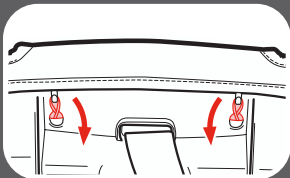
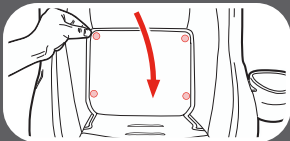

Seat Pad

Clean with a damp sponge using mild soap and cool water. If needed, pad may be removed for cleaning.

To remove the seat pad, unsnap the seat pad on both sides.

From the back of the seat, undo the 2 elastic loops at the top of the seat pad.

Unclip the seat pad at the front edge of the seat. Remove the button clips before washing.

Push harness straps and buckle strap through slots on seat pad and lift seat pad off shell.

Untuck the seat pad and remove the seat pad from the shell.

Machine wash pad in cold water on delicate cycle and drip-dry. **DO NOT USE BLEACH.**

Reverse the steps to reattach the pad to the shell.

9-B Cleaning Buckle

Flip the recline foot to the forward-facing position and locate the metal retainer. Rotate the metal retainer up through the shell and seat pad. From the front, pull the buckle strap out.

To clean buckle, place in a cup of warm water and gently agitate the buckle. Press the red button several times while in the water.

DO NOT SUBMERGE THE BUCKLE STRAP. DO NOT USE SOAPS, HOUSEHOLD DETERGENTS or LUBRICANTS.

Shake out excess water and allow to air dry. Repeat steps as needed until it fastens with a click. Re-insert the buckle into the same slot it was removed. Pull up on buckle strap to make sure it is secured.



WARNING! Inspect and clean buckle from time to time to remove any objects or debris that could prevent latching.

9-C Cleaning Harness, Lower Anchor Attachment and Tether

Surface wash only with mild soap and damp cloth. **DO NOT IMMERSE THE HARNESS STRAPS, LOWER ANCHOR STRAP or TETHER STRAP IN WATER.** Doing so may weaken the straps. If harness straps or lower anchor belt or tether strap are frayed or heavily soiled, contact Customer Service at www.gracobaby.com or 1-800-345-4109.

NOTES:

Replacement Parts

To purchase parts or accessories in the United States, please contact us at the following:

www.gracobaby.com

or

1-800-345-4109

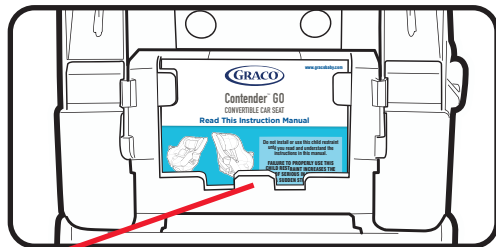

Store instruction manual behind the tab with the instruction book icon as shown.