

baby jogger®



city turn™

CONVERTIBLE CAR SEAT



©2021 baby jogger NWL0001151803E 11/21

babyjogger.com

KEEP INSTRUCTIONS FOR FUTURE USE

Do not install or use this child restraint until you read and understand the instructions in this manual.

FAILURE TO PROPERLY USE THIS CHILD RESTRAINT INCREASES THE RISK OF SERIOUS INJURY OR DEATH IN A SUDDEN STOP OR CRASH.

TABLE OF CONTENTS

Safe Use Checklist	3
Registration.....	5
Recall Information.....	6
Certification.....	6
Warnings.....	7
Features.....	10
• Car Seat Rotation	
• Recline Foot	
• Rapidlock	
• Cup Holder	
Rear-Facing Installation.....	21
• Rear-Facing Safe Use Checklist	
• Install Rear-Facing With Vehicle Seat Belt	
• Install Rear-Facing With Lower Anchor Attachment	
Forward-Facing Installation.....	34
• Forward-Facing Safe Use Checklist	
• Install Forward-Facing With Vehicle Seat Belt and Tether	
• Install Forward-Facing With LATCH	
Securing Child With 5-Point Harness.....	46
Accessories.....	50
• Head and Body Support	
• Lumbar Support	
• Harness Covers	
Choosing a Seat Location.....	52
LATCH / Lower Anchor Attachment System.....	53
Vehicle Seat Belts.....	55
Care and Maintenance.....	59
Warranty.....	63
Replacement Parts.....	64

SAFE USE CHECKLIST

Your child's safety depends on you. No car seat can guarantee protection from injury in every situation, but proper use helps reduce the risk of serious injury or death.

Even if this car seat seems easy to figure out on your own, you must follow the detailed instructions in this instruction manual to ensure the steps below are performed correctly.

SAFE USE CHECKLIST	For More Information...
<p>Review height and weight guidelines to choose the correct mode of use for your child.</p> <ul style="list-style-type: none"> • Rear-Facing: 4-50 lb (1.8-22 kg) • Forward-Facing: 22-65 lb (10-30 kg) and 49" (125 cm) or less • Children less than 22 lb (10 kg) MUST use this car seat rear-facing. 	<p>Review pages 21, 34</p>
<p>Choose a suitable location for this car seat in your vehicle.</p> <ul style="list-style-type: none"> • Never place a child rear-facing in a seating position with an active frontal airbag. 	<p>Review pages 52, 54</p>
<p>Install this car seat tightly in your vehicle.</p> <ul style="list-style-type: none"> • Car seat should not move at the belt path more than 1" (2.5 cm) from side to side and front to back when installed rear-facing or forward-facing. • Use the tether strap when using forward-facing with the 5-point harness system. 	<p>Review pages: Rear-Facing 21 - 33 Forward-Facing 34 - 45</p>

SAFE USE CHECKLIST

For More Information...

Secure your child tightly in this car seat with the 5-point harness system:

- Harness straps should be snug enough you cannot pinch the strap at the shoulder.
- Chest clip should be at armpit level.
- **Rear-Facing:** Harness strap height **MUST BE AT OR JUST BELOW** top of child's shoulders. Top of head **must** be 1" (2.5 cm) below the headrest/harness adjustment lever.
- **Forward-Facing:** Harness strap height **MUST BE AT OR JUST ABOVE** top of child's shoulders. Top of child's ears **must** be below top of headrest.
- The harness covers **MUST** be used when this car seat is installed in Forward-Facing mode.
- **NEVER** rotate the seat while the vehicle is in motion.

Note: Preterm or low birth weight infants may be at special risk in a vehicle or aircraft. According to the AAP, these infants may suffer breathing issues if improperly reclined in a car seat. When rear-facing, use the corrected age for preemies. Baby Jogger advises that you have your physician or hospital staff evaluate your infant and recommend the proper car seat or car bed before you and your infant leave the hospital.

Review pages 46 - 49

REGISTERING YOUR CHILD RESTRAINT

Please complete the pre-paid registration card that is attached to your child restraint and send the portion shown below in today or register online at:

www.babyjogger.com/carseatregistration.

IMPORTANT

In case of a recall, we can reach you only if we have your name and address. You MUST send in the attached card or register online to be on our recall list.

We've already paid the postage.

Do it today.



NO POSTAGE
NECESSARY
IF MAILED
IN THE
UNITED STATES



BUSINESS REPLY MAIL

FIRST-CLASS MAIL PERMIT NO. 66 ELVERSON PA

POSTAGE WILL BE PAID BY ADDRESSEE

BABY JOGGER, LLC
 P.O. BOX 169
 ELVERSON, PA 19520-9901



Tear off and mail this part

IMPORTANT: Debe registrar este asiento para el automóvil para que puedan comunicarse con usted en caso de un llamado de devolución del asiento.

FOR YOUR CHILD'S CONTINUED SAFETY

Please take a few moments to promptly fill out and return the attached card or register online.

Although child restraint systems undergo testing and evaluation, it is possible that a child restraint could be recalled.

In case of recall, we can reach you only if we have your name and address, so please send in the card or register online to be on our recall list.

Please fill this card out and mail it NOW, or register online at <http://www.babyjogger.com/carseatregistration> while you are thinking about it.

The card is already addressed and we've paid the postage.

P1034626C

Consumer: Just fill in your name and address. Please print.

Your first name

Your last name

Your street address

City

State Zip Code -

CHILD RESTRAINT REGISTRATION CARD

BABY JOGGER®
 MODEL NO:
 SERIAL NO:
 MANUFACTURED IN (YYYY/MM/DD):
 DO NOT USE AFTER (YYYY/MM/DD):
 Baby Jogger, LLC, Atlanta, GA 30328
 1.800.241.1848 • www.babyjogger.com • Made In China

Child restraints could be recalled for safety reasons. You must register this restraint to be reached in a recall. Send your name, address, email address if available and the restraint's model number and manufacturing date to:

Baby Jogger, LLC
 P.O. Box 169, Elverson, PA 19520-9901
 or call 1-800-241-1848
 or register online at
www.babyjogger.com/carseatregistration

FOR RECALL INFORMATION

Call the U.S. Government's Vehicle Safety Hotline at 1-888-327-4236 (TTY: 1-800-424-9153), or go to <http://www.NHTSA.gov>.

CERTIFICATION

This child restraint meets or exceeds all applicable requirements of Federal motor vehicle safety standard 213 for use in motor vehicles.



This child restraint is certified for use in aircraft only when used with the internal harness system in forward-facing mode (22-65 lb (10-30 kg) and 49" (125 cm) or less). Use only forward-facing aircraft seats. For forward-facing installation see page 35 and page 57 for Lap Belt Installation, but do not use tether. Contact the airline for their specific policies.



This car seat is NOT certified for use in aircraft when used in rear-facing mode. Contact the airline for their specific policies.

Note: To prevent damage to the seat, lower the headrest when checking the car seat at the airport.

IF YOU NEED ASSISTANCE OR HAVE ANY QUESTIONS

If you have any questions regarding installation of your seat, please contact consumer care:

Baby Jogger, LLC
4110 Premier Drive
High Point, NC 27265
1-800-241-1848
www.babyjogger.com

For information regarding child restraints:
www.NHTSA.gov
www.safekids.org
www.seatcheck.org

WARNING

- Read this Owner's Manual completely **BEFORE** first use of your restraint system!
- Keep instructions for future use.
- Even if using this child restraint seems easy to figure out on your own, it is very important to **READ, UNDERSTAND AND FOLLOW THE OWNER'S MANUAL**.
- Failure to completely follow the instructions provided in this manual as well as the labels on this product can result in **DEATH** or **SERIOUS INJURY**.



- Read your vehicle owner's manual for important information concerning child restraint installation.
- **NEVER PLACE THIS CHILD RESTRAINT REAR-FACING IN A VEHICLE SEATING LOCATION THAT HAS AN ACTIVE FRONT AIRBAG.**
If an airbag inflates, it can hit the child and car seat with great force and cause serious injury or death to your child.
- Review your vehicle owner's manual for more information about airbags and car seat use.
- Only place this child restraint in a rear-facing direction on a forward facing vehicle seat when using it in a vehicle. **NEVER** install this child restraint on vehicle seats that face the side or rear of the vehicle.
- Never leave child unattended.
- **DO NOT ALLOW** anyone who has not read the instruction manual to install or use this child restraint.
- Register your child restraint with the manufacturer.
- This Child Restraint System must not be used without the cover.
- **THE CHILD RESTRAINT CAN BECOME VERY HOT IF LEFT IN THE SUN.** Contact with these parts can burn your child's skin. Always touch the surface of any metal or plastic parts before putting your child in the child restraint.
- **NEVER USE A SECOND-HAND CHILD RESTRAINT** or a child restraint whose history you do not know.
- **DO NOT** ever take a baby out of the restraint system for any reason while vehicle is in motion. If your baby needs attention, find a safe place and pull off the road.
- Do always check the security of your restraint system before each journey.

- Your child can be injured in a vehicle even if you are not in a crash. Sudden braking and sharp turns can injure your child if the child restraint is not properly installed or if your child is not properly secured in the child restraint.
- According to accident statistics, children are safer when properly restrained in the rear seating positions than in the front seating positions.
- Children are safer riding rear-facing and should ride rear-facing as long as possible, until they reach the maximum rear-facing height or weight rating for their car seat. Then children should ride forward-facing, using the built-in harness system for as long as possible until they reach the maximum forward-facing weight or height for their car seat. Be sure to check your local and state laws, as well as AAP and NHTSA recommendations, for car seat usage.
- Secure this child restraint with the vehicle's child restraint lower anchorage system if available or with a vehicle belt.
- Do not use both the vehicle seat belt and lower anchor attachment at the same time when using the car seat with the 5-point harness.
- Always secure car seat with a vehicle seat belt or, lower anchor attachment even when unoccupied. In a crash, an unsecured car seat can injure passengers.
- **ALWAYS** store the lower anchor connectors when they are not being used for installation.
- Never attach two lower anchor connectors to one vehicle lower anchor point unless specifically allowed by the vehicle manufacturer.
- **DO NOT** remove lower anchor attachment system from car seat. If using vehicle seat belt to secure car seat, lower anchor connectors must be stored.
- **DO NOT** allow children to play with or around this child restraint.
- **DO NOT** allow children to enter or exit the rotated seat without assistance.
- If car seat is in a crash, it must be replaced. **DO NOT** use it again! A crash can cause unseen damage and using it again could result in serious injury or death.
- **DISCONTINUE USE** of this child restraint after 10 years from the manufacture date. The manufacture date can be found on the back of your child restraint.
- **DO NOT** use this child restraint unless your child meets the following height and weight criteria:
 - Rear-Facing: 4-50 lb (1.8-22 kg)
 - Forward-Facing: 22-65 lb (10-30 kg) and 49" (125 cm) or lessChildren less than 22 lb (10 kg) **MUST** use this car seat rear-facing.

- Never use this child restraint if it has been damaged or broken or any component is missing. Do not use a cut, frayed or damaged child restraint harness, vehicle seat belt or lower anchor attachment belt.
- It is not intended to be used in low-speed vehicles such as golf carts, ATV's or any other non-certified vehicles.
- **DO NOT** rotate the seat while the vehicle is in use.
- **DO NOT** rotate the seat unless it is securely installed in a vehicle.
- This car seat can **ONLY** be rotated in rear-facing mode.
- **DO NOT** store seat in rotated position.
- Only rotate seat when installing in vehicle rear facing or when securing/removing child.

FEATURES

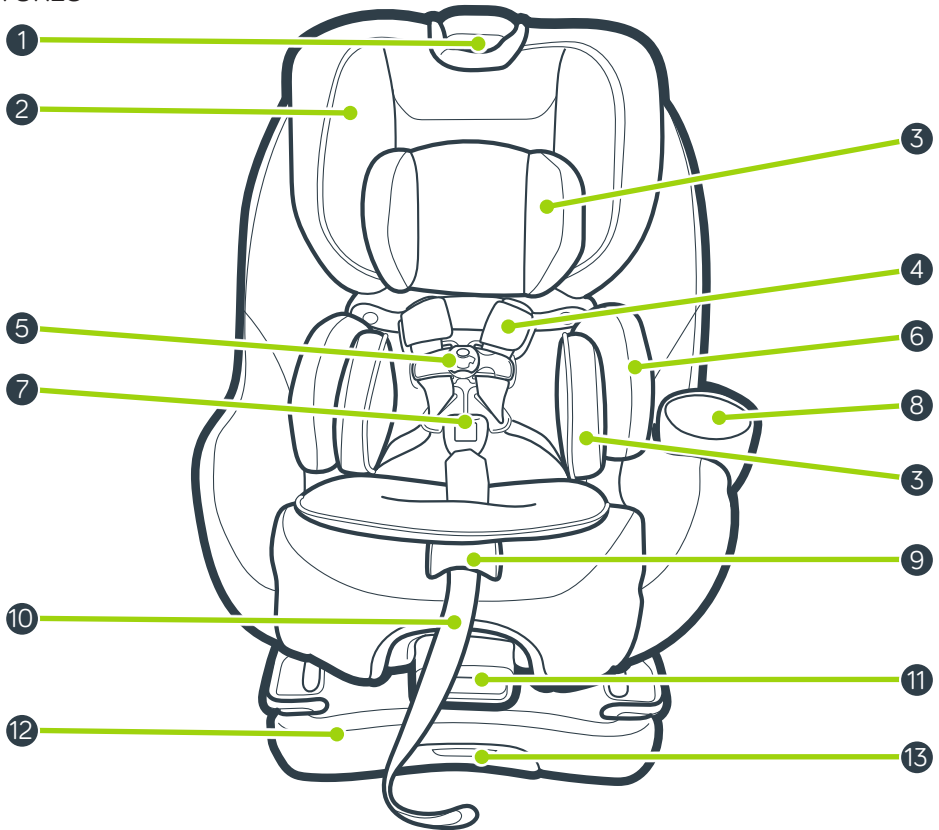

1 Headrest/Harness Adjustment Lever

2 Headrest

3 Head and Body Support

4 Harness Covers

5 Chest Clip

6 Lumbar Support

7 Buckle

8 Cup Holder

9 Harness Release Lever (under seat pad)

10 Harness Adjustment Strap

11 Rotation Lever

12 Seat Base

13 Lower Anchor Storage

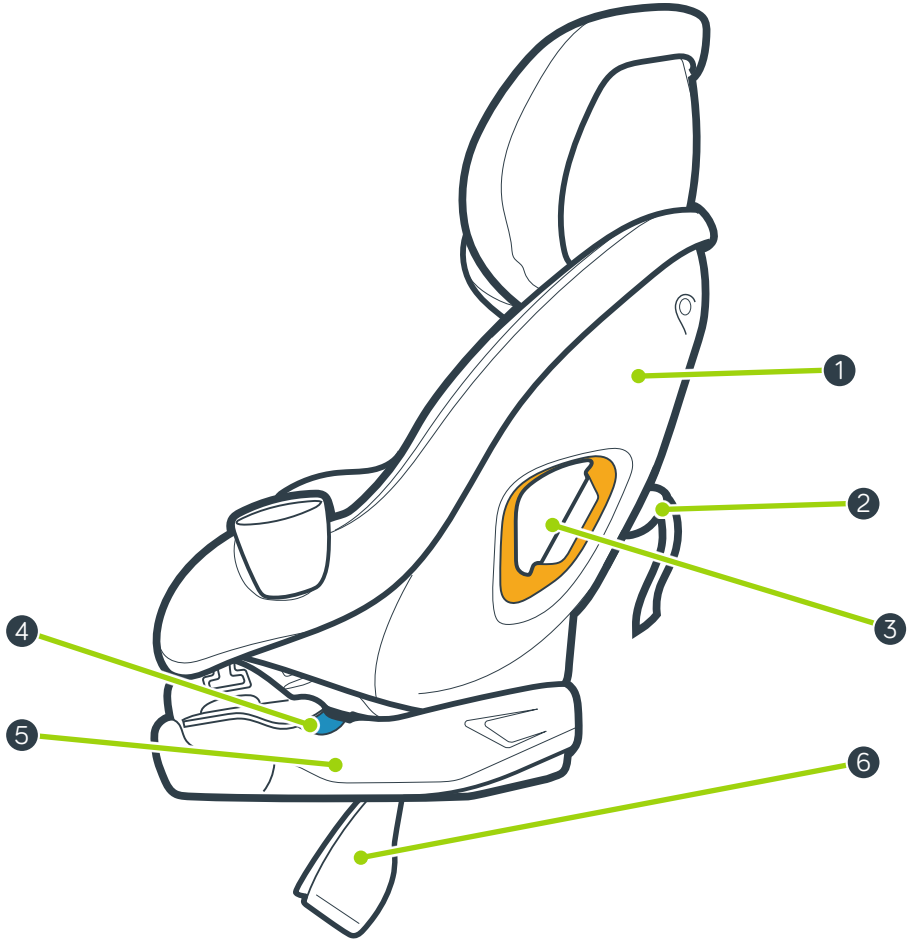

- 1 Seat Shell
- 2 Tether
- 3 Forward-Facing Belt Path
- 4 Rear-Facing Belt Path
- 5 Seat Base
- 6 Recline Foot

FEATURES

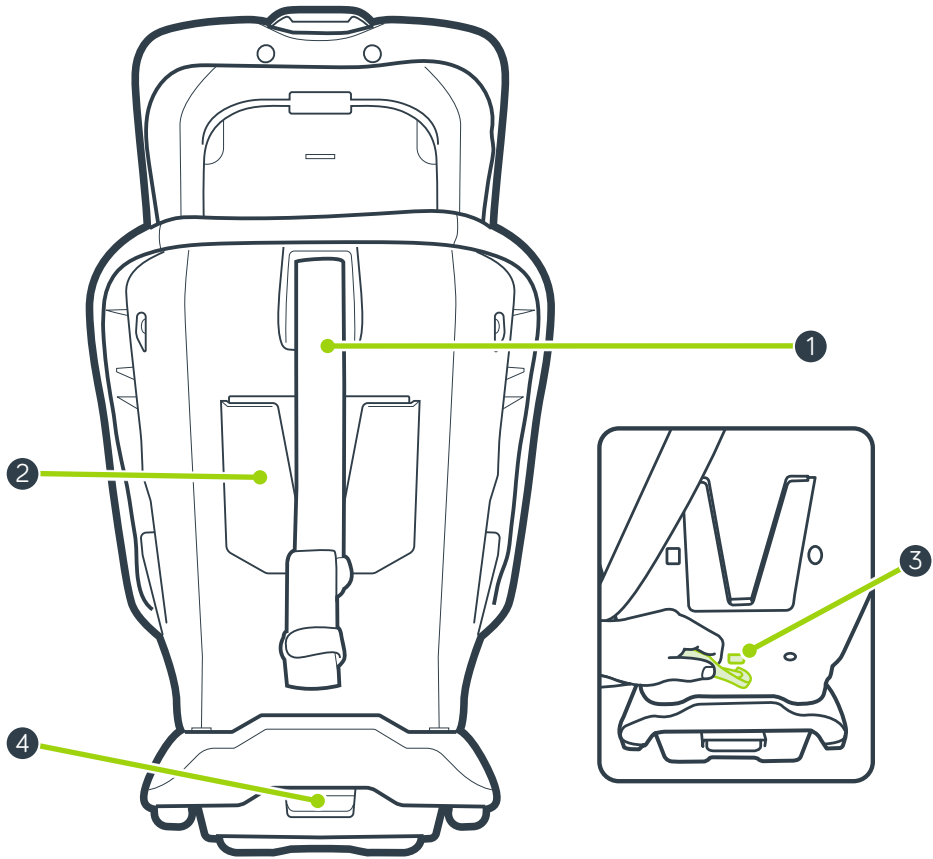

1 Tether Strap

2 Instruction Manual Storage

3 Tether Strap Storage

4 Recline Lever

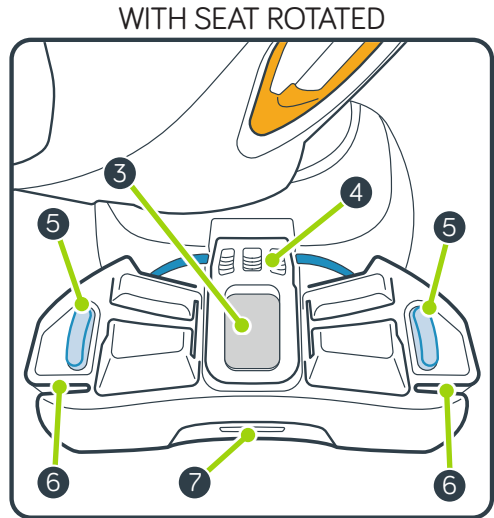
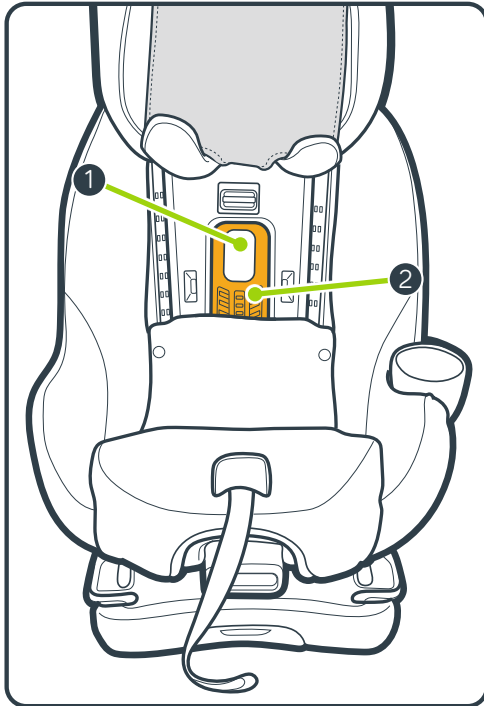

- | | |
|--|-----------------------------------|
| 1 Forward-Facing RAPIDLOCK lock-off Release Button | 5 Rear-Facing Level Indicator |
| 2 Forward-Facing RAPIDLOCK lock-off | 6 Rear-Facing Shoulder Belt Guide |
| 3 Rear-Facing RAPIDLOCK lock-off Release Button | 7 Lower Anchor Storage |
| 4 Rear-Facing RAPIDLOCK lock-off | |

CAR SEAT ROTATION

The car seat can be rotated for rear-facing installation and easy securing of your child in rear-facing mode.

To rotate the car seat, squeeze the lever at the front of the car seat and rotate the seat.

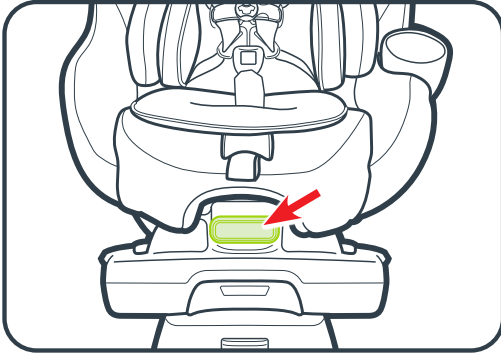

For rear-facing installation the car seat **MUST** be rotated to access rear facing belt path marked with a blue stripe.

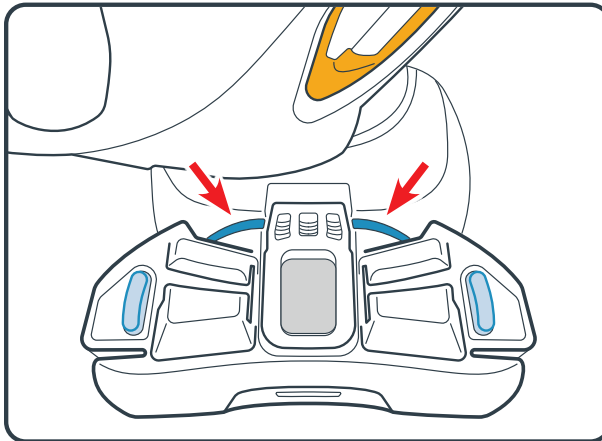

With your child secured, rotate the seat to the rear-facing position. The seat is secure when you hear a “CLICK!” Pull on the sides of the seat to make sure it is locked.

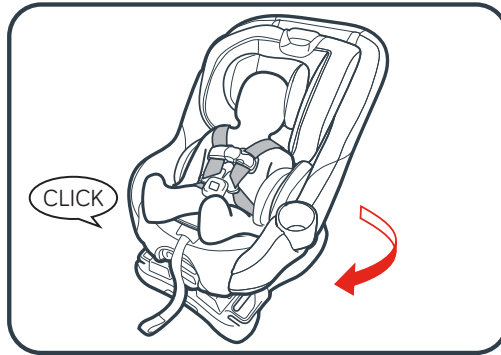

- **This car seat can ONLY be rotated in rear-facing mode. DO NOT rotate the seat when securing the child in forward-facing mode.**
- NEVER rotate the seat while the vehicle is in motion.
- DO NOT rotate the seat unless it is securely installed in a vehicle.
- DO NOT allow children to play with or around this child restraint
- DO NOT place hands under the back of the seat while rotating into the locked position.
- DO NOT store seat in rotated position.
- Only rotate seat when installing in vehicle rear facing or when securing/removing child.

The RAPIDLOCK lock-off **MUST** be used when the car seat is installed rear-facing.

RECLINE FOOT

The recline foot on the bottom of the seat has two positions. The foot **MUST** be in the rear-facing position when the seat is being used in rear-facing mode. When the seat is being used in forward-facing mode, the foot **MUST** be in the forward-facing position.

REAR-FACING POSITION

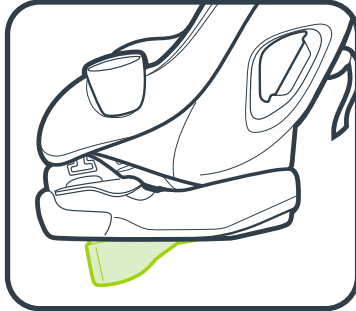

FORWARD-FACING POSITION



The correct position is marked with a label on the side of the foot. The foot is correctly in the rear-facing position with the blue text is facing up. The foot is correctly in the forward-facing position with the orange text is facing up.

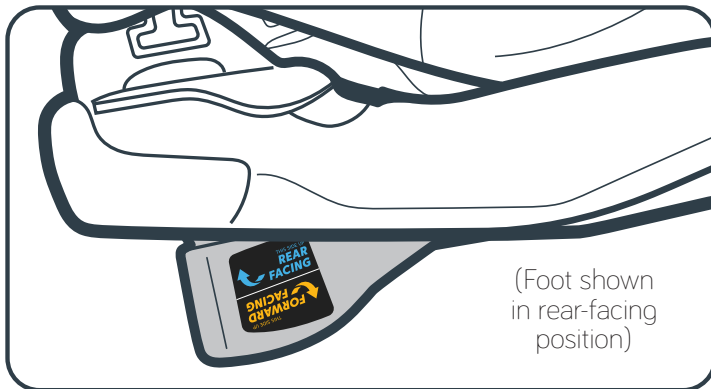

(Foot shown in rear-facing position)

Unsnap the foot from base by pulling on the foot. Swing the foot forward or back to change positions. The recline foot is secure when it “clicks” into place.

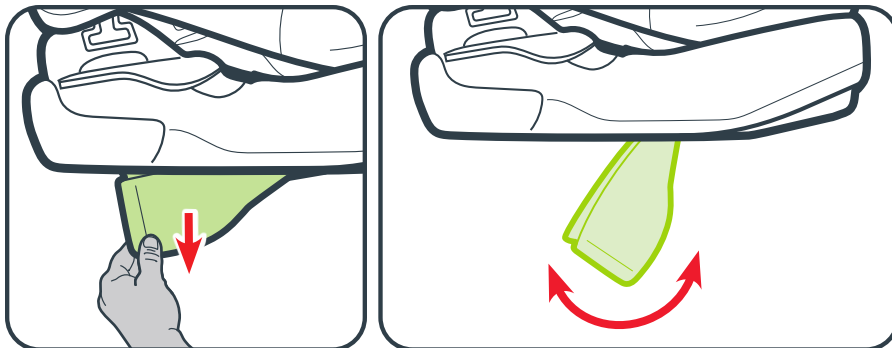

Recline Lever :

The height of the recline foot is also adjustable. Squeeze the recline lever on the front of the foot and lift the base to extend the foot. Squeeze the recline lever and lower the base to retract the foot.

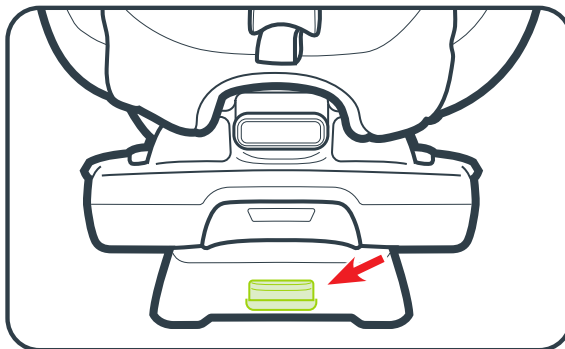

(Foot shown in rear-facing position)

The foot has 3 recline positions. Always make sure to recheck the level indicator after adjusting the recline when using the seat in rear-facing mode.

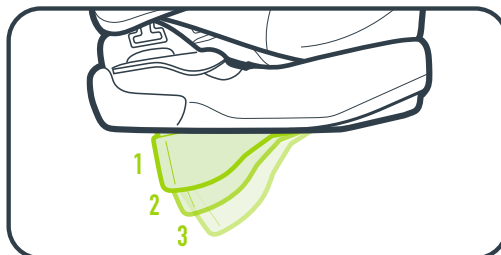

RAPIDLOCK

This seat comes with a lock-off feature called RAPIDLOCK. The RAPIDLOCK lock-off makes tightening the seat belt or lower anchor strap quick and easy. There are two RAPIDLOCK lock-offs on this seat, one for rear-facing mode, and one for forward-facing mode.



The rear-facing RAPIDLOCK is located on the base and can only be found by rotating the seat.

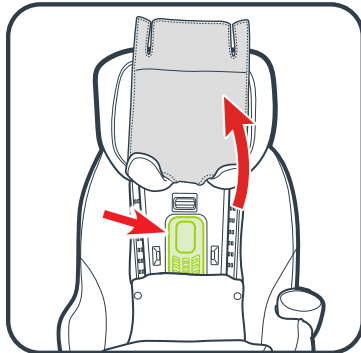

The forward-facing RAPIDLOCK is located in the seatback under the seat pad. Find it by raising the headrest to its highest position and lifting the headrest pad up and out of the way.

Push the grey button to open the RAPIDLOCK,

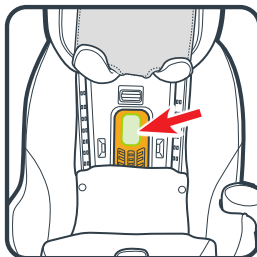
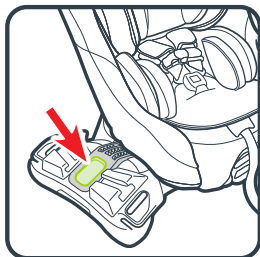

When installing the seat with the vehicle seat belt, **BOTH** the lap portion and the shoulder portion of the vehicle seat belt **MUST** be routed under the RAPIDLOCK arm. If your vehicle seat belt only has a lap belt, then route the lap belt under the RAPIDLOCK. When installing the seat with the lower anchor attachment system, the lower anchor strap is routed under the RAPIDLOCK. An example of a rear-facing installation is shown below:

VEHICLE LAP AND SHOULDER BELT

LOWER ANCHOR ATTACHMENT

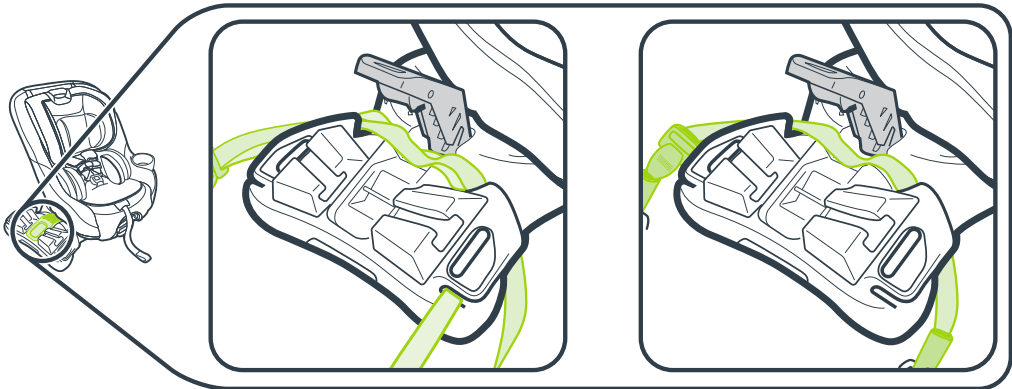

Remove vehicle seat belt or lower anchor strap slack. Press down firmly near the front of the base. (rear-facing installation with vehicle lap and shoulder belt shown).

Do not pull on the belt with excessive force. If the belt or strap is too tight, you will not be able to close the RAPIDLOCK.

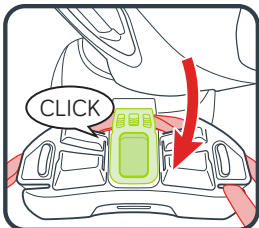

When the slack is removed, close the RAPIDLOCK Lock-Off until you hear a "Click". Make sure the vehicle seat belt or lower anchor strap is under the RAPIDLOCK Lock-Off.

The RAPIDLOCK lock-off MUST be used when installing this seat rear-facing.

CUP HOLDER

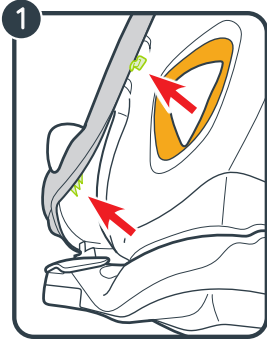

Cup holder **MUST** be installed.

1. From the left side of the seat, pull the seat pad out of the lower ribs and the lower clip to fully expose the cup holder slot.

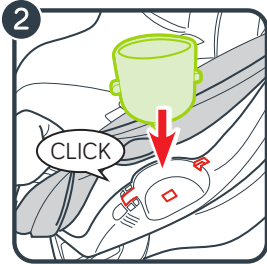
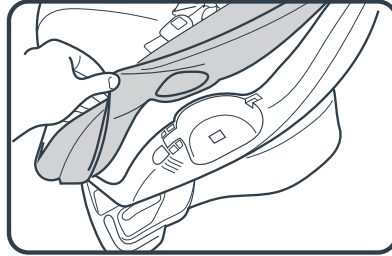

2. Align the tabs on the cup holder with the slots in the shell and insert the cup holder until you hear a "Click!"

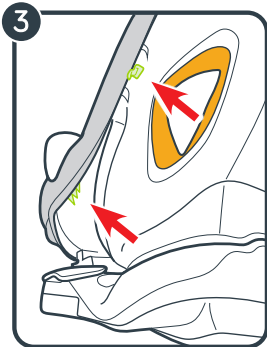

3. To reattach the seat pad, insert the edges of the pad fabric into the clip found inside the car seat shell and the ribs near the bottom of the cup holder.

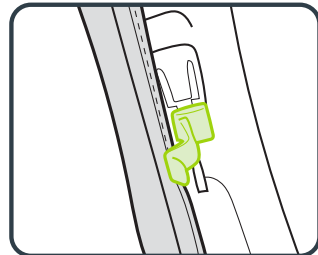
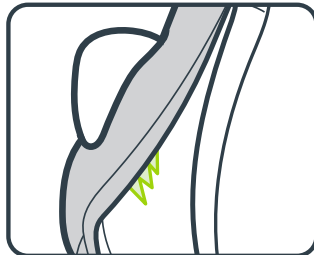

REAR-FACING SAFE USE

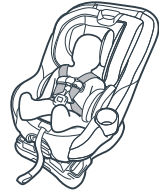

VEHICLE LAP/SHOULDER SEAT BELT

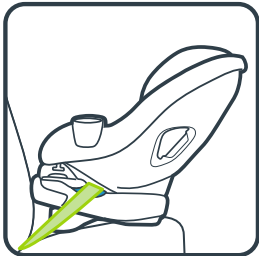

VEHICLE LAP ONLY SEAT BELT



LOWER ANCHOR ATTACHMENT

Do not install by this method for a child weighing more than 35 lb (16 kg)

Rear-Facing:

4-50 lb (1.8-22 kg) and whose head is at least 1 inch (2.5 cm) below the headrest adjustment handle*

- ✔ Place the car seat rear-facing in the vehicle back seat.
- ✔ Make sure lower anchor strap or vehicle seat belt is routed through the rear-facing belt path, marked with a blue stripe.
- ✔ Install this car seat tightly in your vehicle. Car seat **should not move** at the rear-facing belt path more than 1" (2.5 cm) from side to side and front to back.
- ✔ Vehicle **MUST** be on level ground.
- ✔ Check the rear-facing level indicator to make sure the seat is level.
- ✔ Harness straps must be **at or just below** the top of child's shoulders and chest clip must be at **armpit level**.
- ⚠ Infants who weigh less than 22 lb (10 kg) **MUST be rear-facing**.
- ⚠ The AAP recommends that children ride rear-facing until the age of 2 or until they reach the maximum rear-facing height or weight rating for their car seat. This car seat can remain rear-facing up to 50 lb (22 kg).
- ⚠ The RAPIDLOCK lock-off **MUST** be used when installing this seat rear-facing.



⚠ WARNING! NEVER place this child restraint rear-facing in a vehicle seating location that has an active front airbag.

*Check your state laws and the AAP/NHTSA recommendations.

Continue reading on the next page to learn how to install this car seat!



INSTALL REAR-FACING WITH VEHICLE SEAT BELT

Make sure the cup holder is installed before installing the seat in your car. See the "Features" section on page 20 to install the cup holder.

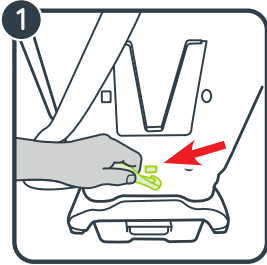

1. Store the tether strap by attaching the tether hook to the slot on the back on the car seat.

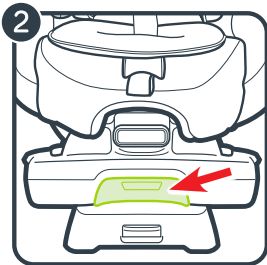

2. Store the lower anchor connectors inside the lower anchor storage compartment. Open the storage compartment door and attach the lower anchor connectors to the storage bars. Tuck the lower anchor strap into the storage compartment, close the compartment door.

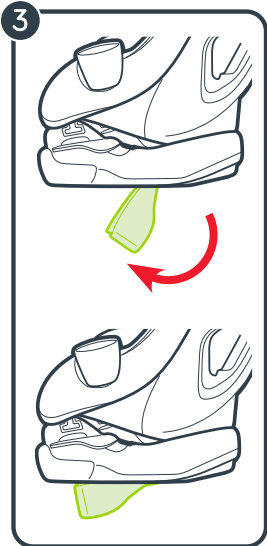
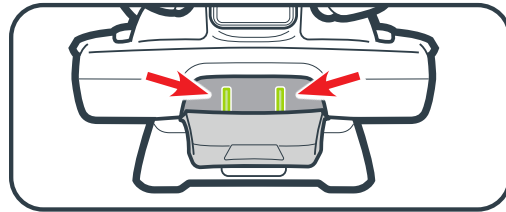

3. Rotate the recline foot on the bottom of the car seat into the rear-facing position marked with a blue label. The recline foot is secure when it "clicks" into place.

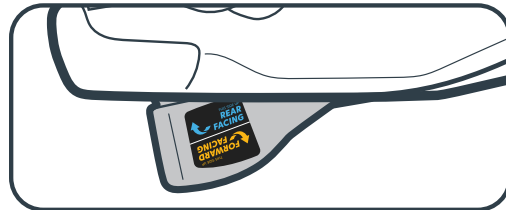

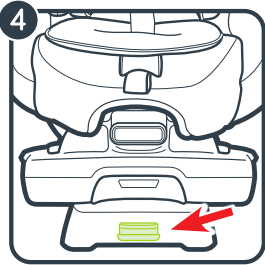

4. Extend the recline foot. The recline foot has 3 recline positions. Squeeze the recline lever and lift the base to extend the foot. Squeeze the recline lever and lower the base to retract the foot. Check the level indicator for appropriate install.

- Children over 40 lb (18 kg), **MUST** use recline position 1.

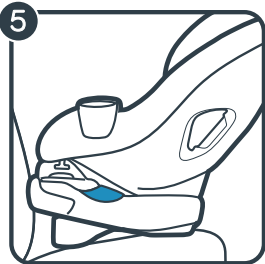
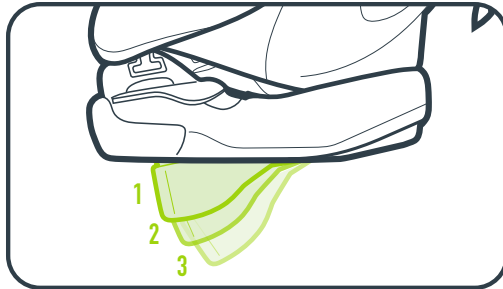

5. Place car seat rear-facing in back seat of the vehicle. Place the base flat on the vehicle seat. Push it back until the front of the car seat touches the vehicle seat back.

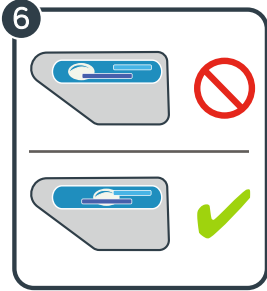

6. Check the level indicator. Vehicle **MUST** be on level ground. **Bubble must be completely under the blue lines.** Adjust the recline until the bubble is completely under the blue lines. For infants 3 months and under, the bubble must be entirely under the light blue line.

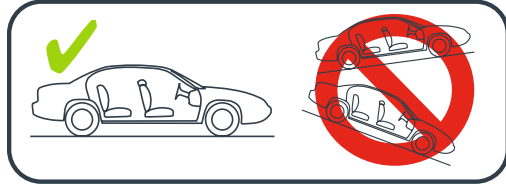

If needed, rolled towels may be placed under the car seat at the vehicle seat crease, until the bubble is completely under the blue lines.

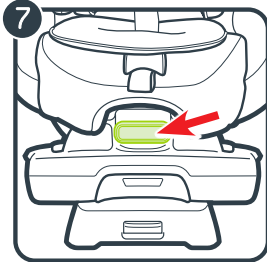

7. Squeeze the rotation lever at the front of the car seat and rotate the seat. The seat may be rotated towards or away from you.

The seat **MUST** be rotated to install in rear-facing mode.

Tip! You may find it easier to install the seat with it rotated away from you.

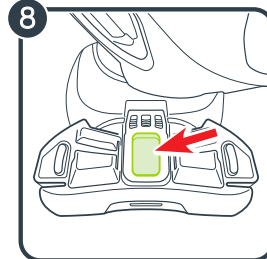

8. Open the RAPIDLOCK lock-off by pushing the gray button and lifting the lock-off arm.

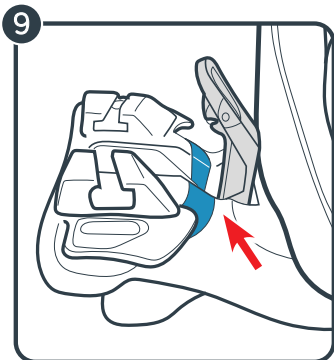

Review your vehicle's owner manual for vehicle seat belt use.

9. Route both vehicle lap and shoulder belt along the blue stripe across the base and under the RAPIDLOCK lock-off arm.

Slide the vehicle shoulder belt through the slit near the edge of the base.

Buckle the seat belt. The seat belt should lie as flat as possible and not be twisted.

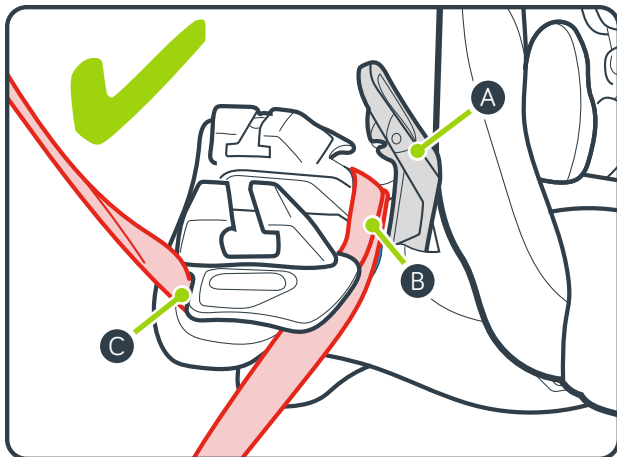

CORRECT:

Both the lap and shoulder belt are routed together along the blue stripe and under the RAPIDLOCK lock-off arm, and the shoulder belt goes through the slit near the edge of the base.

A : RAPIDLOCK lock-off arm

B : Rear-Facing belt path

C : Shoulder belt slit

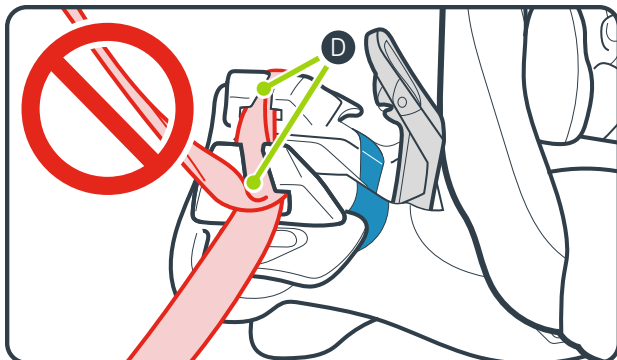

INCORRECT:

DO NOT route the lap and shoulder belt through the "T" shaped seat rotation channels.

D : Seat rotation channels



10. Remove vehicle seat belt slack. Press down firmly near the front of the base. Pull on the shoulder belt to tighten while feeding the slack back in the retractor.

Do not pull on the belt with excessive force. If the belt is too tight, you will not be able to close the RAPIDLOCK.

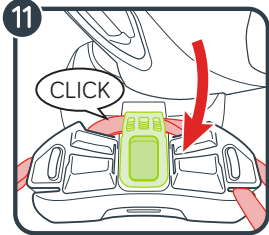

11. When the slack is removed, close the RAPIDLOCK Lock-Off until you hear a "Click". Make sure the vehicle seat belt is under the RAPIDLOCK Lock-Off.

The RAPIDLOCK lock-off MUST be used when installing this seat rear-facing.

⚠ WARNING!

Keep hands away from the RAPIDLOCK lock-off area when closing the RAPIDLOCK lock-off.

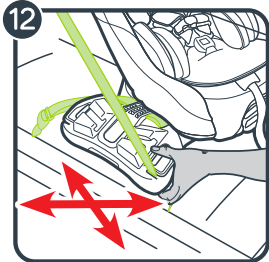

12. Test for tightness. Grab the sides of the base where the seat belt is and slide the base side to side and front to back. If the base moves less than 1" (2.5 cm), it is tight enough.

If the RAPIDLOCK lock-off can't be used with the vehicle seat belt, then the Lower Anchor Attachment **MUST** be used with the RAPIDLOCK lock-off. See page 28 to install rear-facing with lower anchor attachment.



13. Place your child in the seat and secure the child with the 5-point harness.

See page 46 “Securing Child With 5-Point Harness”

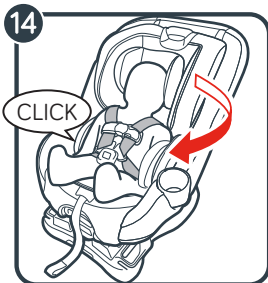

14. With your child secured, rotate the seat to the rear-facing position. The seat is secure when you hear a “CLICK!”

Pull on the sides of the seat to make sure it is locked.

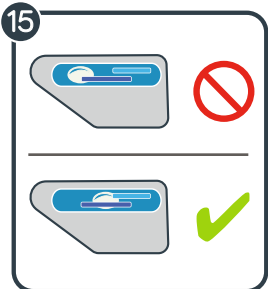

15. Check the level indicator. Vehicle **MUST** be on level ground. **Bubble must be completely under the blue lines.** Adjust the recline until the bubble is completely under the blue lines. For infants 3 months and under, the bubble must be entirely under the light blue line.

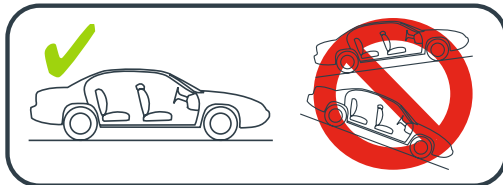

If needed, rolled towels may be placed under the car seat at the vehicle seat crease, until the bubble is completely under the blue lines.

INSTALL REAR-FACING WITH LOWER ANCHOR ATTACHMENT

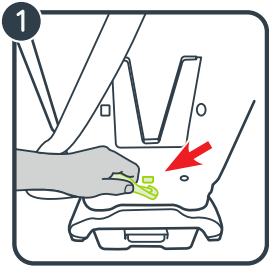

Make sure the cup holder is installed before installing the seat in your car. See the “Features” section on page 20 to install the cup holder.

Review your vehicle’s owner’s manual for LATCH location and use. Do not install by this method for a child weighing more than 35 lb (16 kg)

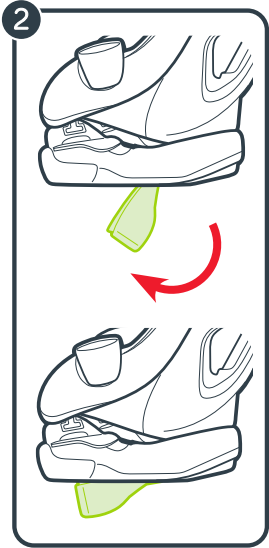

1. Store the tether strap by attaching the tether hook to the slot on the back on the car seat.

2. Rotate the recline foot on the bottom of the car seat into the rear-facing position marked with a blue label. The recline foot is secure when it “clicks” into place.

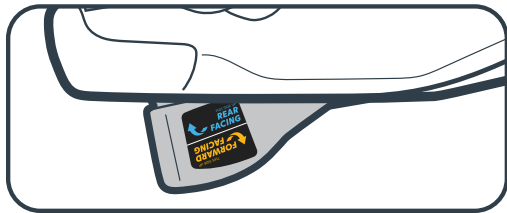

3. Extend the recline foot. The recline foot has 3 recline positions. Squeeze the recline lever and lift the base to extend the foot. Squeeze the recline lever and lower the base to retract the foot. Check the level indicator for appropriate install.

- Children over 40 lb (18 kg), **MUST** use recline position 1.

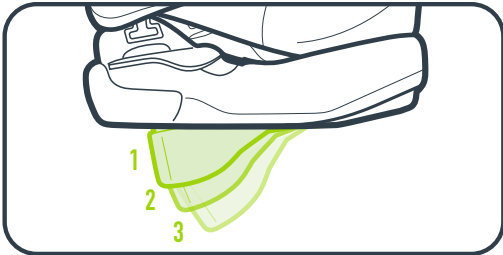
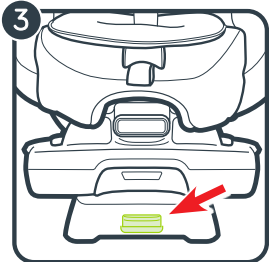

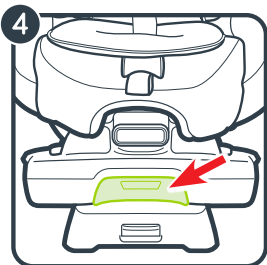

4. From the front of the car seat, open the lower anchor storage door. Remove the lower anchor strap and connectors from the storage compartment. Use one hand to press the red button on the connector. While pressing the button, use your other hand to pull the strap and remove from storage. Repeat for the other connector. Close the lower anchor storage door.

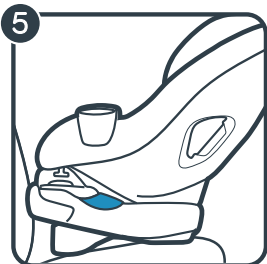
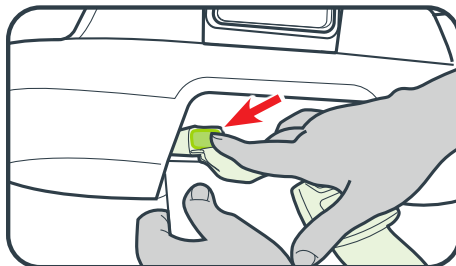

5. Place car seat rear-facing in back seat of the vehicle. Place the base flat on the vehicle seat. Push it back until the front of the car seat touches the vehicle seat back. Center the car seat between the vehicle lower anchor points.

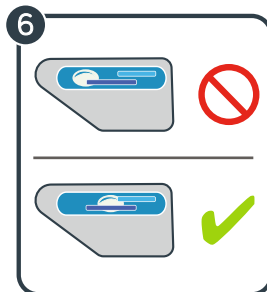

6. Check the level indicator. Vehicle **MUST** be on level ground. **Bubble must be completely under the blue lines.** Adjust the recline until the bubble is completely under the blue lines. For infants 3 months and under, the bubble must be entirely under the light blue line.

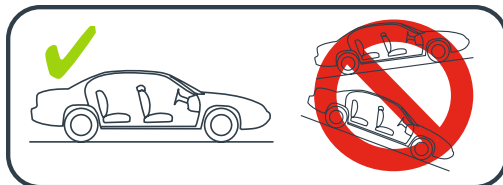

If needed, rolled towels may be placed under the car seat at the vehicle seat crease, until the bubble is completely under the blue lines.

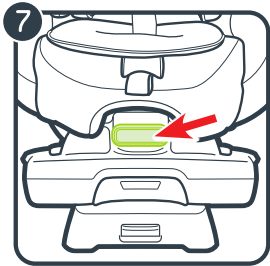

7. Squeeze the rotation lever at the front of the car seat and rotate the seat. The seat may be rotated towards or away from you.

The seat **MUST** be rotated to install in rear-facing mode.

Tip! You may find it easier to install the seat with it rotated away from you.

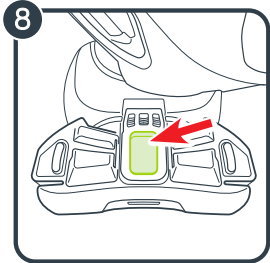

8. Open the RAPIDLOCK lock-off by pushing the gray button and lifting the lock-off arm.

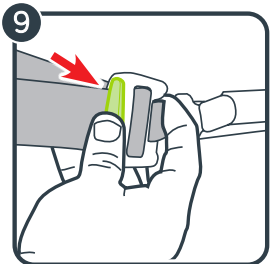

9. For easier installation, extend the lower anchor strap to its maximum length by pressing the gray button and pulling on the strap.

10

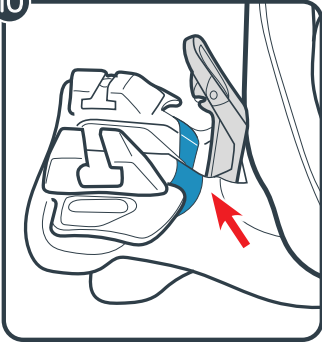

10. Route the lower anchor strap along the blue stripe across the base and under the RAPIDLOCK lock-off arm.

The lower anchor strap should not be twisted. If twisted, you will not be able to tighten the strap.

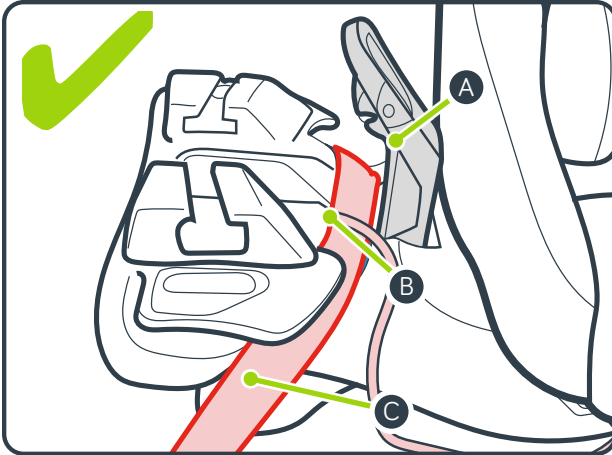

CORRECT:

The lower anchor strap is routed along the blue stripe and under the RAPIDLOCK arm.

A : RAPIDLOCK lock-off arm

B : Rear-Facing belt path

C : Lower anchor strap

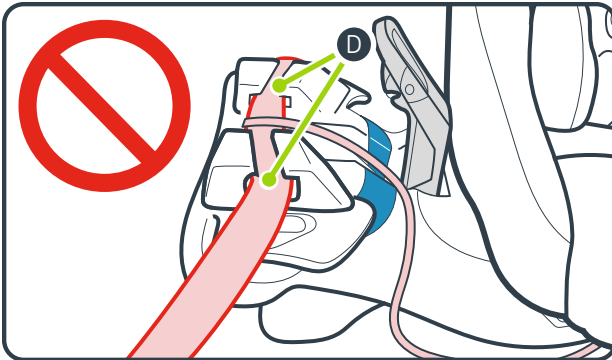

INCORRECT:

DO NOT route the lower anchor strap through the "T" shaped seat rotation channels.

D : Seat rotation channels

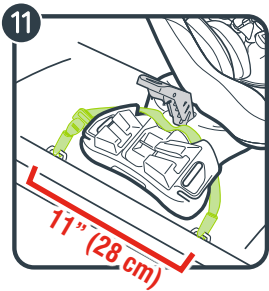

11. Attach the lower anchor connectors to the vehicle's lower anchors. Make sure the arrows are pointing up.

Lower anchor attachment can only be used if the vehicle lower anchor spacing is 11" (28 cm) from the center of one lower anchor to the center of the other lower anchor.

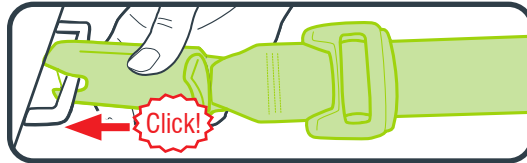
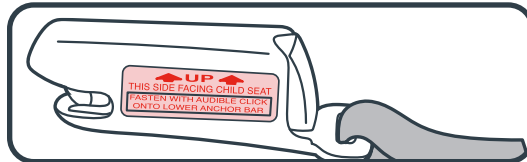

12. Remove lower anchor strap slack. Press down firmly near the front of the base while tightening the lower anchor strap.

Do not pull on the strap with excessive force. If the strap is too tight, you will not be able to close the RAPIDLOCK.

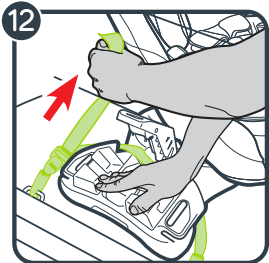

13. When the slack is removed, close the RAPIDLOCK Lock-Off until you hear a "Click". Make sure the lower anchor strap is under the RAPIDLOCK Lock-Off.

The RAPIDLOCK lock-off MUST be used when installing this seat rear-facing.

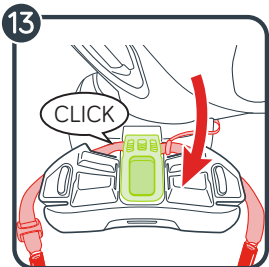

⚠ WARNING!

Keep hands away from the RAPIDLOCK lock-off area when closing the RAPIDLOCK lock-off.

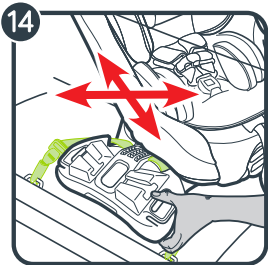

14. Test for tightness. Grab the sides of the base where the lower anchor strap is and slide the base side to side and front to back.
If the base moves less than 1" (2.5 cm), it is tight enough.



15 Place your child in the seat and secure the child with the 5-point harness.

See page 46 “Securing Child With 5-Point Harness”



16 With your child secured, rotate the seat to the rear-facing position. The seat is secure when you hear a “CLICK!”

Pull on the sides of the seat to make sure it is locked.

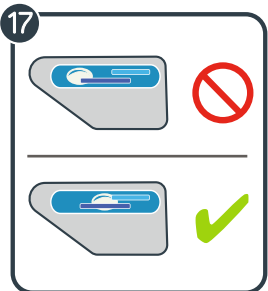

17. Check the level indicator. Vehicle **MUST** be on level ground. **Bubble must be completely under the blue lines.** Adjust the recline until the bubble is completely under the blue lines. For infants 3 months and under, **the bubble must be entirely under the light blue line.**

If needed, rolled towels may be placed under the car seat at the vehicle seat crease, until the bubble is completely under the blue lines.

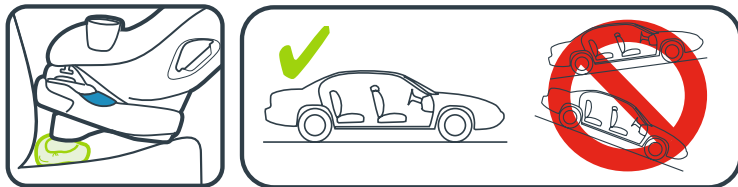

FORWARD-FACING SAFE USE

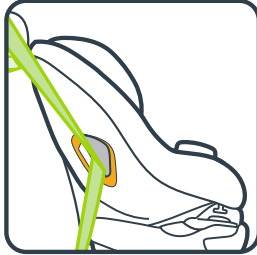

VEHICLE LAP/
SHOULDER SEAT BELT
WITH TETHER STRAP

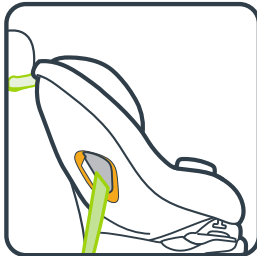

VEHICLE LAP ONLY
SEAT BELT WITH
TETHER STRAP



LOWER ANCHOR
ATTACHMENT WITH
TETHER STRAP

Do not install by this method for a child weighing more than 40 lb (18kg)

Forward-Facing:

22-65 lb (10-30 kg) and 49" (125 cm) or less. *

- ✓ Place the car seat forward-facing in the vehicle back seat.
- ✓ Make sure lower anchor strap or vehicle seat belt is routed through the forward-facing belt path, marked with a orange label.
- ✓ Install this car seat tightly in your vehicle. Car seat **should not move** at the forward-facing belt path more than 1" (2.5 cm) from side to side and front to back.
- ✓ Attach and tighten tether strap.
- ✓ Harness straps must be **at or just above** the top of child's shoulders and chest clip must be at **armpit level**.
- ⚠ The harness covers **MUST** be used when this car seat is installed in Forward-Facing mode.
- ⚠ The AAP recommends that children ride rear-facing until the age of 2 or until they reach the maximum rear-facing height or weight rating for their seat, and when forward-facing, children should use the built-in harness system for as long as possible until they reach the maximum forward-facing weight or height for their car seat. This car seat can remain rear-facing up to 50 lb (22 kg) and forward-facing up 65 lb (30 kg).
- ⚠ The rotate feature can only be used when the car seat is installed in rear-facing mode. **DO NOT** try to rotate the seat in forward-facing mode.

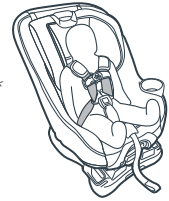

*Check your state laws and the AAP/NHTSA recommendations.

Continue reading on the next page to learn how to install this car seat!



INSTALL FORWARD-FACING WITH VEHICLE SEAT BELT AND TETHER

Make sure the cup holder is installed before installing the seat in your car. See the "Features" section on page 20 to install the cup holder.

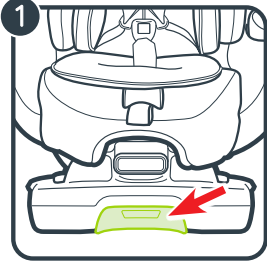

1. Store the lower anchor connectors inside the lower anchor storage compartment. Open the storage compartment door and attach the lower anchor connectors to the storage bars. Tuck the lower anchor strap into the storage compartment, close the compartment door.

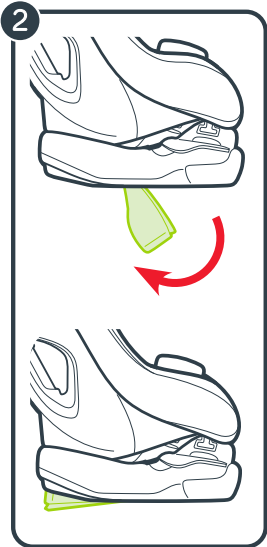
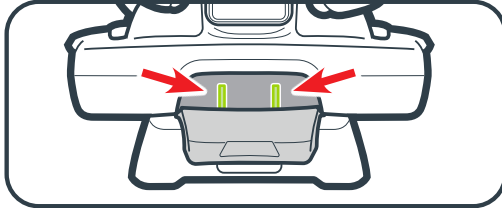

2. Rotate the recline foot on the bottom of the car seat into the forward-facing position marked with an orange label. The recline foot is secure when it "clicks" into place.

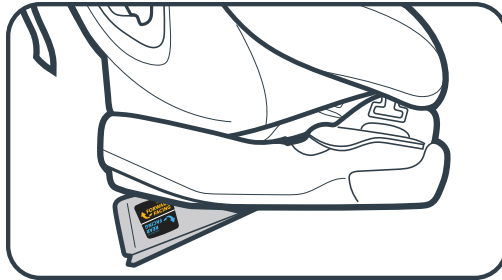

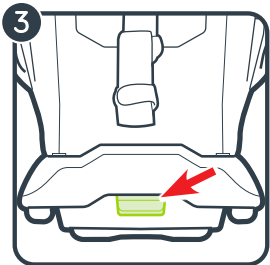

3. Expand the recline foot. The recline foot has 3 recline positions. Squeeze the recline lever and lift the base to extend the foot. Squeeze the recline lever and lower the base to retract the foot.

- Children 40-65 lb (18-30 kg), **MUST** use recline position 1.
- Children less than 40 lb (18 kg), **MUST** use recline position 3.

NOTE: The level indicator is used only in rear-facing mode.

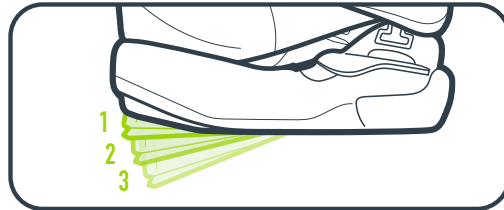
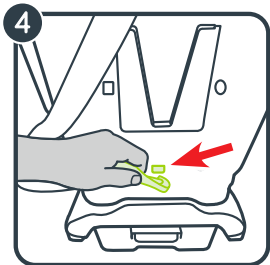

4. Unhook the tether from the storage location on the back on the seat, and lay it over the front of the seat.

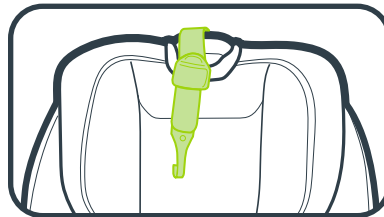
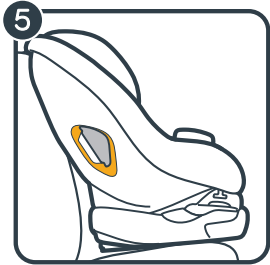

5. Place car seat forward-facing in back seat of the vehicle. Place the base flat on the vehicle seat. Push it back firmly until the back of the car seat touches the vehicle seat back.

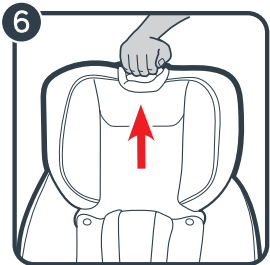

6. Squeeze the headrest adjustment handle and raise the headrest to the highest position.

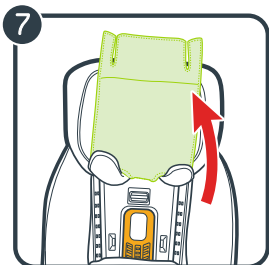

7. Lift the headrest pad flap up out of the way.

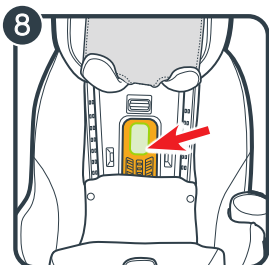

8. Open the RAPIDLOCK lock-off by pushing the gray button and lifting the lock-off arm.

Review your vehicle's owner manual for vehicle seat belt use.

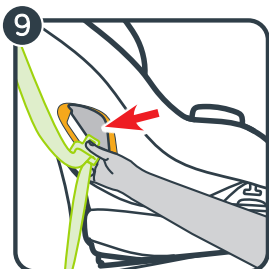

9. Thread vehicle seat belt through the orange forward-facing belt path, through the RAPIDLOCK lock-off, and out the other side. Buckle the seat belt. The seat belt should lay as flat as possible and not be twisted.

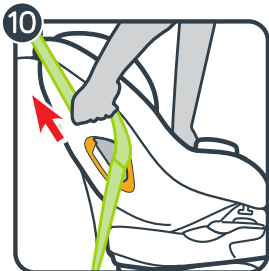
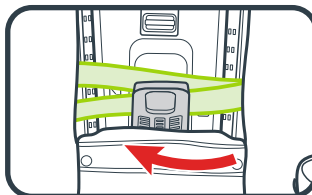

10. Remove vehicle seat belt slack. Press down firmly in the center of the car seat. Pull on the shoulder belt to tighten while feeding the slack back in the retractor.

Do not pull on the belt with excessive force. If the belt is too tight, you will not be able to close the RAPIDLOCK.

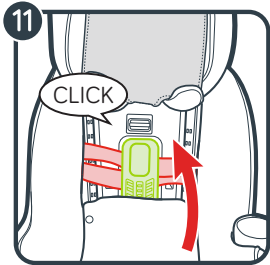

11. When the slack is removed, close the RAPIDLOCK lock-off until you hear a “Click”. Make sure the vehicle seat belt is under the RAPIDLOCK Lock-Off.

! WARNING!

Keep hands away from the RAPIDLOCK lock-off area when closing the RAPIDLOCK lock-off.

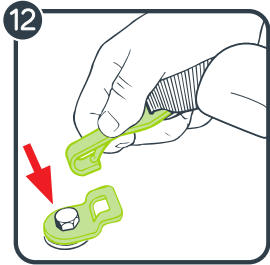

12. Attach tether strap. Extend the tether by lifting up on the tether lock and attach to vehicle tether anchor. Consult vehicle’s owner manual for specific location. The tether strap should not be twisted. If twisted, you will not be able to tighten the strap.

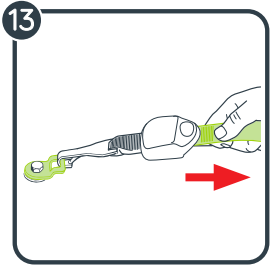
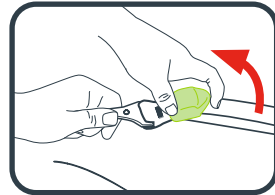

13. Tighten tether strap. Remove all the slack.



14. Test for tightness. Grab the sides of the seat where the vehicle seat belt is and slide the car seat side to side and front to back. If the seat moves less than 1” (2.5 cm), it is tight enough.

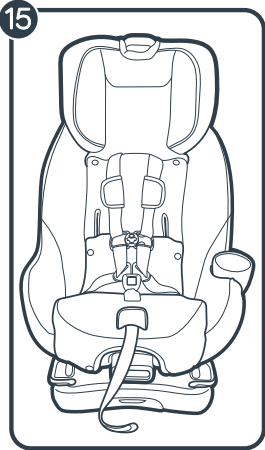

15. Replace the seat pad. Move the headrest back to its proper position for your child.

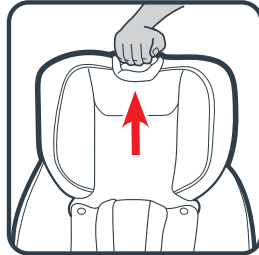

See page 46 “Securing Child With 5-Point Harness”

INSTALL FORWARD-FACING WITH LATCH

Make sure the cup holder is installed before installing the seat in your car. See the "Features" section on page 20 to install the cup holder.

Review your vehicle's owner manual for LATCH location and use. Do not install by this method for a child weighing more than 40 lb (18 kg)

1. Rotate the recline foot on the bottom of the car seat into the forward-facing position marked with an orange label. The recline foot is secure when it "clicks" into place.

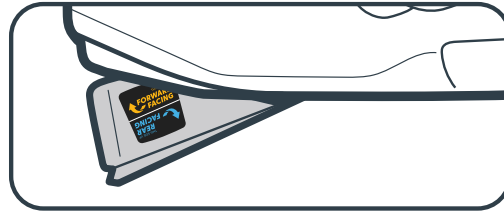
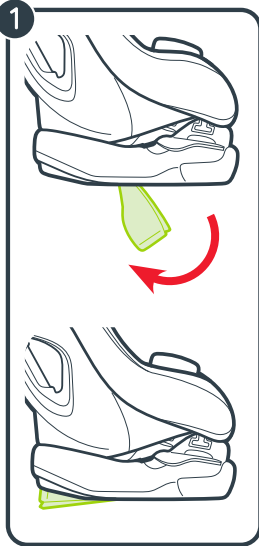

2. Expand the recline foot. The recline foot has 3 recline positions. Squeeze the recline lever and lift the base to extend the foot. Squeeze the recline lever and lower the base to retract the foot.

- Children 40-65 lb (18-30 kg), **MUST** use recline position 1.
- Children less than 40 lb (18 kg), **MUST** use recline position 3.

NOTE: The level indicator is used only in rear-facing mode.

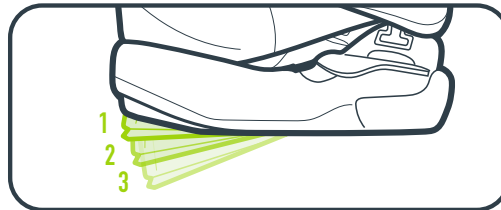
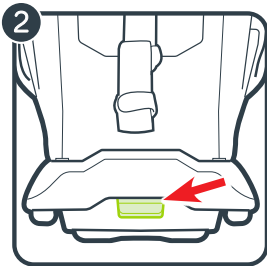

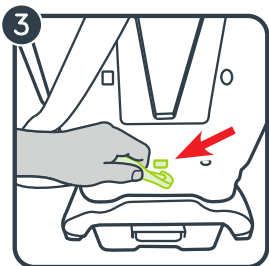

3. Unhook the tether from the storage location on the back on the seat, and lay it over the front of the seat.

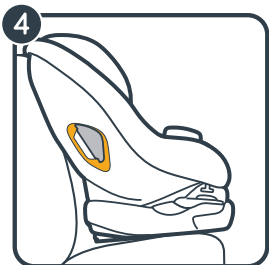
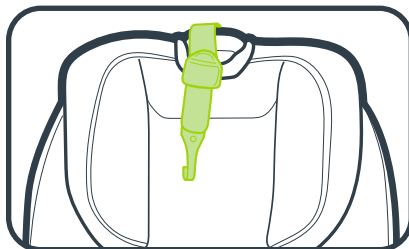

4. Place car seat forward-facing in back seat of the vehicle. Place the base flat on the vehicle seat. Push it back firmly until the back of the car seat touches the vehicle seat back. Center the car seat between the vehicle lower anchor points.

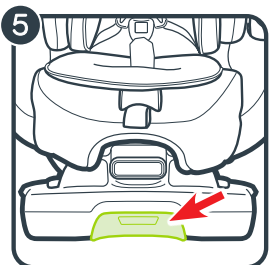

5. From the front of the car seat, open the lower anchor storage door. Remove the lower anchor strap and connectors from the storage compartment. Use one hand to press the red button on the connector. While pressing the button, use your other hand to pull the strap and remove from storage. Repeat for the other connector. Close the lower anchor storage door.

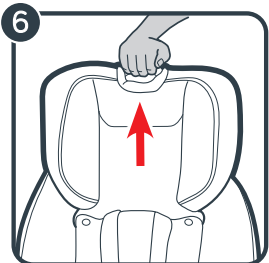
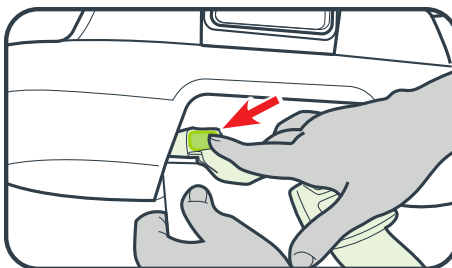

6. Squeeze the headrest adjustment handle and raise the headrest to the highest position.

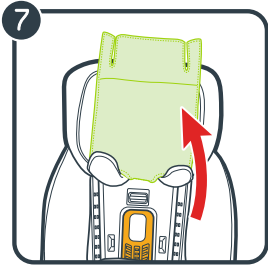

7. Lift the headrest pad flap up out of the way.

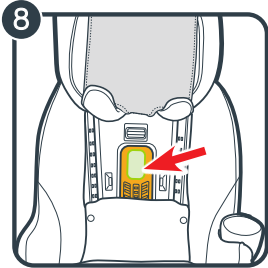

8. Open the RAPIDLOCK lock-off by pushing the gray button and lifting the lock-off arm.

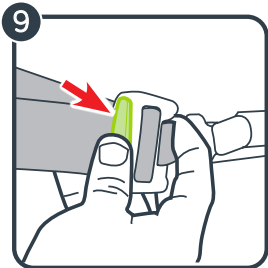

9. For easier installation, extend the lower anchor strap to its maximum length by pressing the gray button and pulling out on the strap.

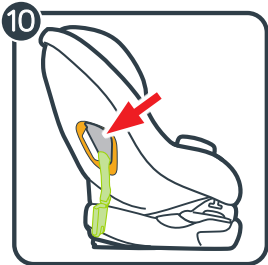

10 Thread the lower anchor strap through the orange forward-facing belt path, through the RAPIDLOCK lock-off, and out the other side. The lower anchor strap should lie as flat as possible and not be twisted.

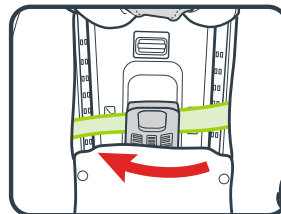

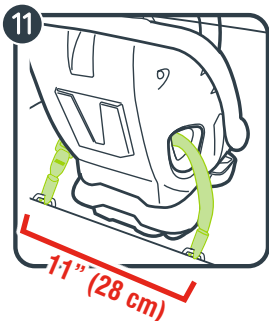

11. Attach lower anchor connectors to vehicle's lower anchors. Make sure the arrows are pointing up.

Lower anchor attachment can only be used if the vehicle lower anchor spacing is 11" (28 cm) from the center of one lower anchor to the center of the other lower anchor.

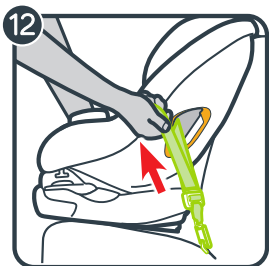
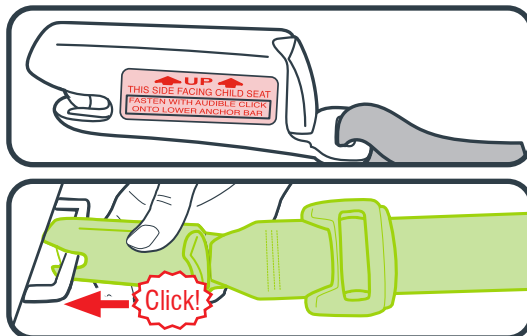

12. Remove lower anchor strap slack. Press down firmly in the center of the car seat while tightening the lower anchor strap. You may need to tighten through the slit in the pad at the belt path as shown.

Do not pull on the strap with excessive force. If the strap is too tight, you will not be able to close the RAPIDLOCK.

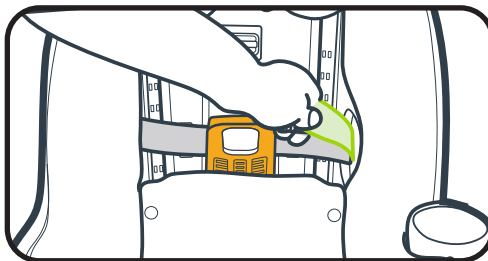

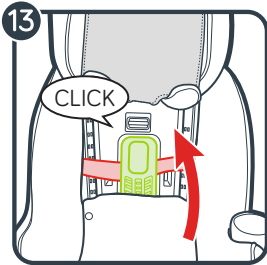

13. When the slack is removed, close the RAPIDLOCK Lock-Off until you hear a “Click”. Make sure the lower anchor strap is under the RAPIDLOCK Lock-Off.

⚠ WARNING!

Keep hands away from the RAPIDLOCK lock-off area when closing the RAPIDLOCK lock-off.

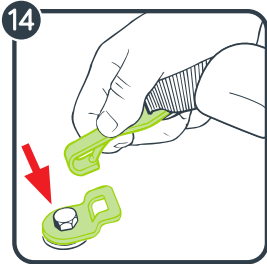

14. Attach tether strap. Extend the tether by lifting up on the tether lock and attach. Consult vehicle’s owner manual for specific location. The tether strap should not be twisted. If twisted, you will not be able to tighten the strap.

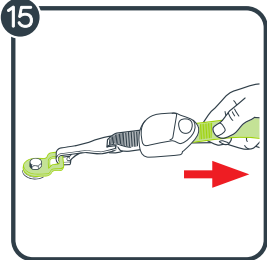
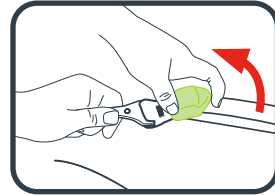

15. Tighten tether strap. Remove all the slack.

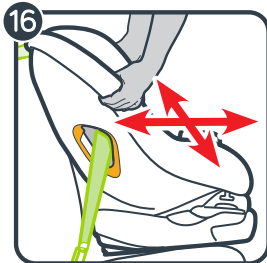

16. Test for tightness. Grab the sides of the seat where the lower anchor strap is and slide the car seat side to side and front to back. If the seat moves less than 1” (2.5 cm), it is tight enough.

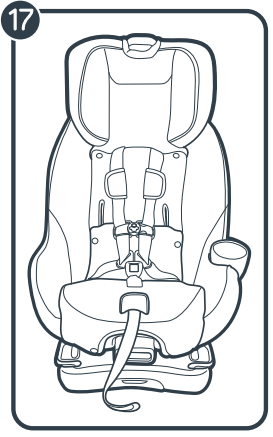

17. Replace the seat pad. Move the headrest back to its proper position for your child.

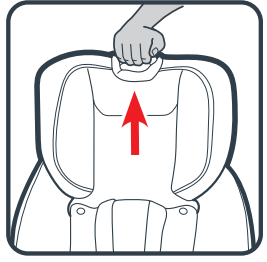

See page 46 “Securing Child With 5-Point Harness”

SECURING CHILD WITH 5-POINT HARNESS

⚠️ WARNING!

WARNING! In cold weather, do not put snowsuits or bulky garments on your child when placing them in the car seat. Bulky clothing can prevent the harness straps from being tightened properly. To keep child warm, buckle your child in the car seat and place a blanket around the child or place the child's coat on backwards after buckling in.

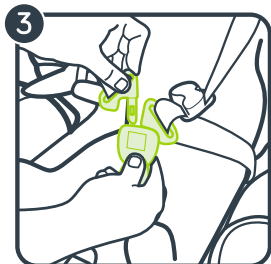
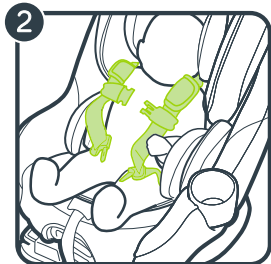
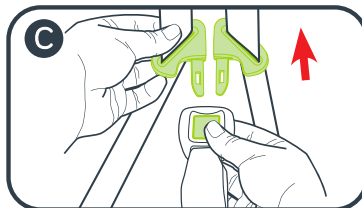
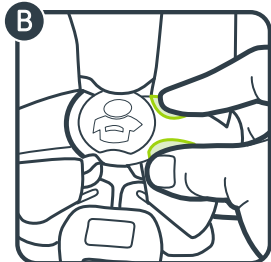
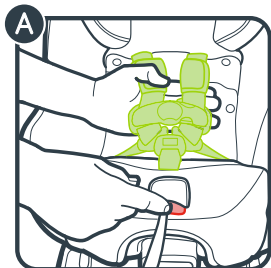

1. Loosen harness straps. Push down on the harness release lever of the front of the seat while pulling out on the harness straps at the chest clip (A). Unbuckle the chest clip (B) and the buckle (C). Place harness straps off to the sides.

2. Place your child in the seat. Make sure their back is flat against the car seat back. Bulky or heavy clothing will prevent the harness straps from tightening properly. If needed, place a blanket over the child after you have secured them.

3. Place harness straps over child's shoulders and buckle the harness buckle. You will hear a "click" when buckle tongues are securely attached. Pull up on each buckle tongue to make sure it is securely attached.

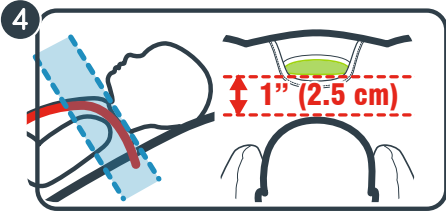

4. Be sure the harness straps are at the proper height.

Rear-facing: harness straps must be **at or just below** the child's shoulders and top of head **must be at least 1" (2.5 cm) below** the headrest/harness adjustment handle.

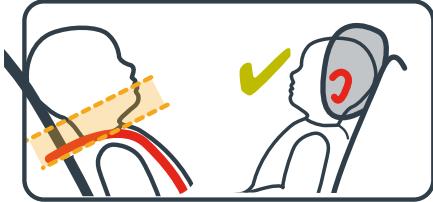

Forward-facing: harness straps must be **at or just above** the child's shoulders and top of child's ears must be **below** top of headrest.

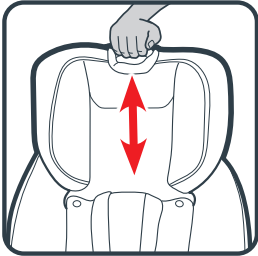

To raise or lower headrest/harness height, squeeze the adjustment handle and move headrest for the proper harness height.

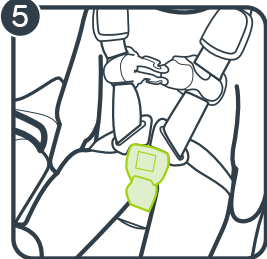
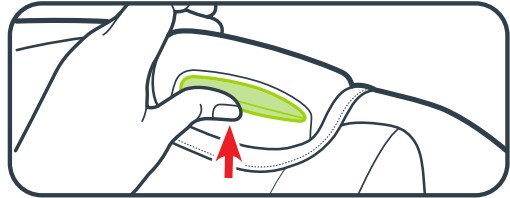

5. Check the buckle position. The correct slot is the one that is closest to your child without being underneath them.

To adjust, pull out the two plastic buttons on the front of the car seat. You may have to rotate the seat to access the two buttons.

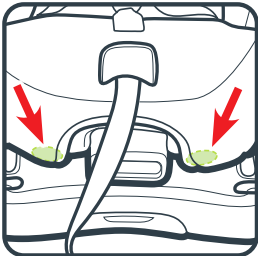

Then, lift the lower seat pad from front of car seat to expose the buckle slots.

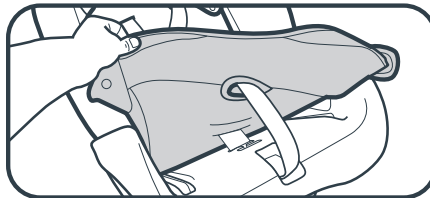

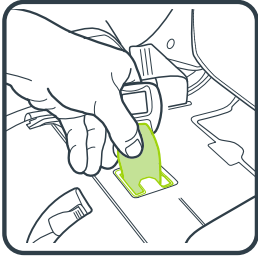

Turn buckle strap sideways and slide to desired slot. Make sure buckle strap is in one of the two positions.

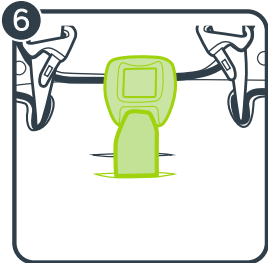
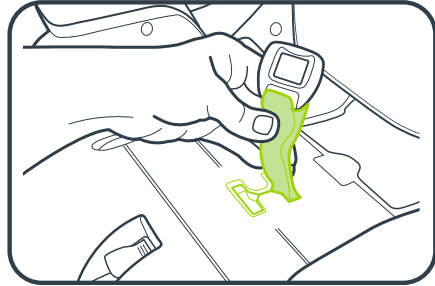

6. Replace seat pad, making sure the buckle goes through the same slot in the seat pad as in the plastic shell

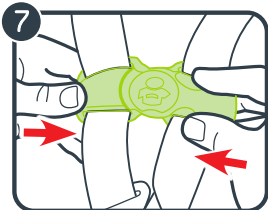

7. Buckle the chest clip. You will hear a "click" when the chest clip is securely buckled.

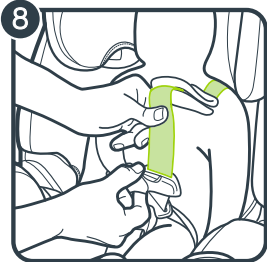

8. Pull all the slack out from around the waist. Pull up on the harness strap while pushing the chest clip down. Do this to both sides.

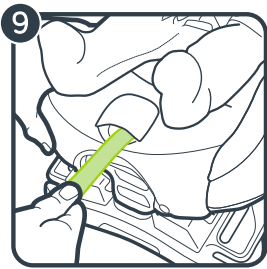

9. Tighten the harness by pulling the harness adjustment strap. A snug harness should not allow any slack. It lies in a relatively straight line without sagging. It does not press on the child's flesh or push the child's body into an unnatural position.

When you are not able to pinch any of the harness webbing at your child's shoulder, the harness is tight enough.

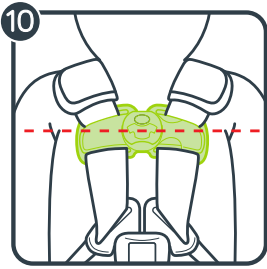
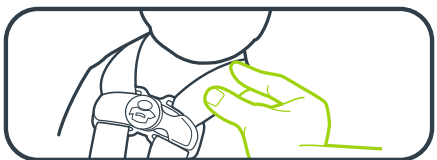

10. Raise the chest clip to child's armpit level

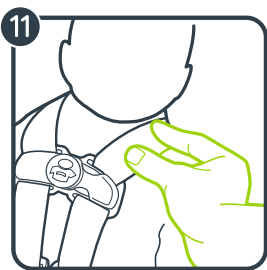

11. Check tightness. Tighten more if needed.

ACCESSORIES (on select models)

All infant support pieces (Head and Body Support, Lower-Seat Pad, and Lumbar Support) can be used Rear-Facing up to 15 lb (7 kg). This may vary slightly depending on child's stature. Use the infant support pieces to ensure the child is secure, comfortable, and their head does not tilt forward. Use the following guidelines:

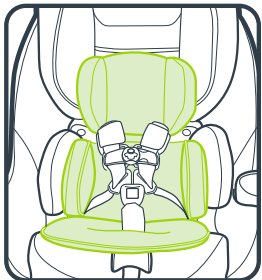

Head and Body Support with the Lower-Seat Pad

- Use only in the rear-facing mode.
- The head and body support must be used if shoulders are below the lowest harness setting.
- Never allow head and body support to bunch or fold behind child.
- Do not use the head support without the lumbar support.

To install, thread the head support straps through the headrest and use the fastening strips to connect the straps together.

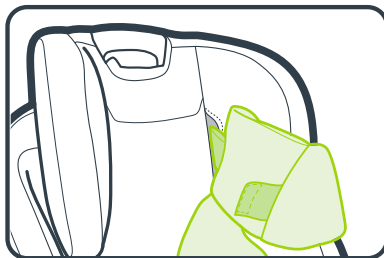

Then thread the buckle through the slot on the seat pad portion of the body support.

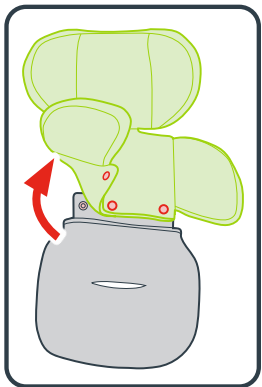

To remove, undo the fastening strips and pull the straps out of the headrest.

Unbuckle the harness and buckle, then pull out the body support.

Note: The upper-head and body support portion may be separated from the lower-seat pad portion by undoing the three snaps.

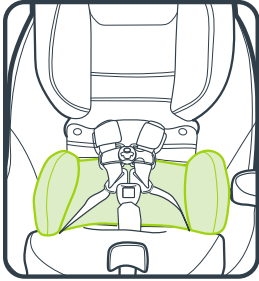

Lumbar Support

- When the seat is used in forward-facing mode, the lumbar support can be used with a child weighing less than 25 lb (11 kg).
- Never allow lumbar support to bunch or fold behind child.

To remove, pull the lumbar support out from behind the head and body support.

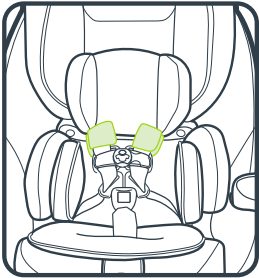

Harness Covers

- The harness covers **MUST** be used when this car seat is installed in Forward-Facing mode.
- Make sure that harness covers do not interfere with placement of the chest clip at armpit level.
- Make sure the rubber side of the harness covers are facing toward the child.
- Rear-Facing fit may vary and harness covers are optional. The harness covers may be too large for newborns.

To remove, undo the fastening strips and remove.

CHOOSING VEHICLE SEAT LOCATION



⚠️ WARNING!

- NEVER place this child restraint rear-facing in a vehicle seating location that has an active front airbag. DEATH or SERIOUS INJURY can occur.
- Failure to place the child restraint in the correct seating positions increases the risk of serious injury or death.

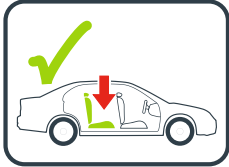

- The back seat is the safest place for children 12 and under. Owners of vehicles with airbags should refer to their owner's manual for child restraint installation instructions.



- The VEHICLE seat must face forward.
- Some vehicles have specific requirements for where the car seat can be installed, so be sure to check your vehicle owner's manual for available seating positions, if any.
- NEVER place the child restraint on any vehicle seat that does not lock. Folding seats can fall forward and could cause serious injury to your child in a vehicle crash.

In the event there is no available back seat and / or you have no other option than to place a child other than an infant in a rear-facing car seat in a front passenger seating position, the National Highway Traffic Safety Administration (NHTSA) recommends that you take the following steps:

- Ensure the child is properly restrained according to their age and size.
- Move the seat as far back as possible.
- Make sure the child is not leaning out of position, such as leaning forward into the deployment path of the airbag.
- Set the airbag ON-OFF switch, if available, to the OFF position.

LATCH / LOWER ANCHOR ATTACHMENT SYSTEM

LATCH stands for Lower Anchors and Tethers for Children. LATCH consists of lower anchors and tether anchors, which are built-in to your vehicle, and connecting hooks that are built-in to your car seat. Lower anchors are used **INSTEAD** of the vehicle's seat belt to secure the child seat to the vehicle. Tethers are used **IN ADDITION** to the lower anchors **OR** the vehicle's seat belt to secure a forward-facing car seat to the vehicle.

The lower anchor attachment system can make installation easier without using the vehicle's seat belts. Lower anchor attachment is a way to secure your child restraint to your vehicle by using the lower anchor connectors on your child restraint. These connectors attach to the lower anchors in certain vehicle seating positions. Refer to your vehicle owner's manual for lower anchor locations.

The child restraint's lower anchors are designed to be used at the standard lower anchor spacing of 11" (28 cm) from the center of one anchor point to the center of another anchor point. Please refer to your vehicle owner's manual for information about using lower anchors in certain seating positions.

If your vehicle does not have lower anchor points, you can still safely install your child restraint with the vehicle's belt system.

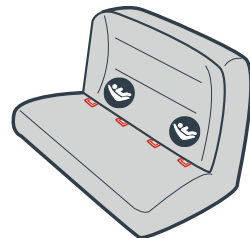

CHOOSING LOWER ANCHOR ATTACHMENT OR SEAT BELTS

This car seat can be installed in your vehicle using either the vehicle seat belt **OR** the LATCH system, both are equally safe to use.

For seating positions equipped with lower anchors, experts recommend trying the lower anchor attachment installation first and only using the seat belt in that seating position if lower anchor attachment, for some reason, results in a looser fit. If you want to use the center rear seat and lower anchor attachment is not available in that position (check the vehicle owner's manual), try the seat belt to be sure you can get a tight installation. If you cannot, try using lower anchor attachment in a different seating position. Remember to only use lower anchor attachment in seating positions recommended by your vehicle manufacturer.

Do not use the lower anchors of the child restraint anchorage system (LATCH system) to attach this child restraint when restraining a child weighing more than 35 lb (16 kg) when used in rear-facing mode, and 40 lb (18 kg) when used in forward-facing mode with the internal harnesses of the child restraint.

HOW TO REMOVE LOWER ANCHOR CONNECTORS AND TETHER

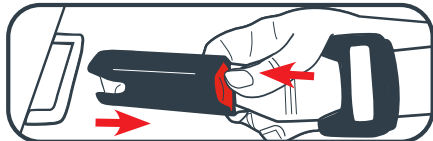

Lower Anchor Attachment

To remove the lower anchor connectors from the lower anchors, push in on the red buttons and pull them off.

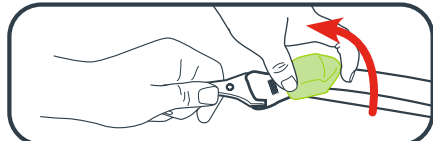

Tether Strap

To remove, lift up on the tether lock to release the tension.

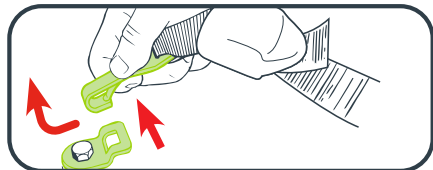

Press in on the hook's spring. Push tether hook in, then lift up and pull away from tether anchor.

UNSAFE VEHICLE SEAT BELTS

⚠️ WARNING! The following types of vehicle seat belts are NOT compatible with this child seat. If any of the belt types listed are in the chosen seating position, choose another seating position within in the vehicle.



Motorized Shoulder Belt with Lap Belt



Lap or Shoulder Belt Mounted on Vehicle Door

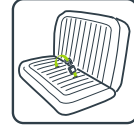

Belts Forward of the Seat Crease

In some vehicles you may not get a secure fit. Read both your vehicle and car seat manuals.

SAFE VEHICLE SEAT BELTS

There are two different types of vehicle seat belts that can be used with this car seat:

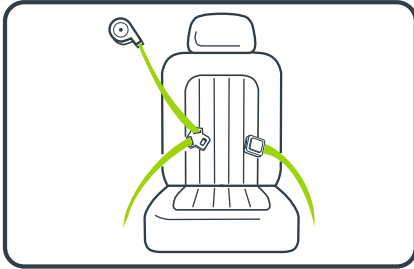

Lap/Shoulder Seat Belt

3 connection points. Can be used in all car seats modes of use.

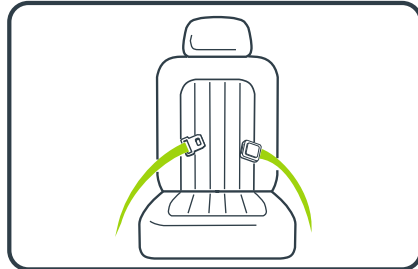

Lap Only Seat Belt

2 connection points.

LAP/SHOULDER SEAT BELT INSTALLATION - HARNESS MODE

Always review your vehicle owner's manual for specific information about your vehicle seat belts.

There are three types of retractors: ELR (Emergency Locking Retractor), ALR (Automatic Locking Retractor) , and Switchable (ELR switch to ALR). To determine your type of retractor, follow these steps:

1. **Slowly** pull the belt out about halfway and stop.
2. Let the belt retract back several inches.
3. Try to **slowly** pull the belt out more. If the belt cannot be pulled any further, it is **ALR**. If it can be pulled further, go to the next step.
4. **Slowly** pull the belt all the way out, and then allow it to retract several inches.
5. Try to pull the belt all the way out again. If it cannot be pulled out, it is **Switchable**. If it can still be pulled out freely, it is **ELR**.

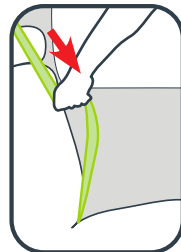

Note: Most vehicles manufactured after 1996 will have switchable retractors in the back seat. If you have any questions about your retractor type, consult your vehicle owner's manual or call Baby Jogger for assistance.

HOW TO LOCK YOUR LAP/SHOULDER VEHICLE SEAT BELT

Sliding Latch Plate and Switchable Retractor

A latchplate that slides freely on the belt webbing and cannot, by itself, hold the belt snug around a car seat.

When installing the car seat, route the vehicle seat belt through the proper belt path and buckle it in. **Slowly pull the shoulder belt all the way out to switch it to locking mode.** Then, as you pull the vehicle seat belt tight, feed all the slack back into the retractor.

Grab the sides of the seat at the belt path and slide the seat side to side and front to back. The seat should not move more than 1" (2.5 cm).

Note: With the vehicle seat belt in this locking mode, all the tension is upwards in the shoulder belt. This may start to tilt your car seat sideways. If this happens, use a locking clip instead of switching the retractor. See Sliding Latch Plate and ELR Retractor.

Note: When using the RAPIDLOCK lock-off, you are not required to switch the retractor as an installation step. The RAPIDLOCK lock-off locks the seat belt. However, it is recommended to switch the retractor after the installation is complete to avoid a possible strangulation risk.

- When using the lock-off, route the vehicle seat belt into the proper belt path under the lock-off and buckle. Push down firmly on the center of the seat while pulling on the shoulder belt to remove the slack. Do not pull on the strap with excessive force. Close and lock the RAPIDLOCK lock-off. Test for tightness. Slowly pull the shoulder belt all the way out to switch it to locking mode.

Locking Latchplate and ELR Retractor

A latchplate that holds the lap belt snug after it has been adjusted; contains a metal bar on the underside of the hardware that "locks" the belt in position.

When installing the car seat, route the vehicle seat belt through the proper belt path and buckle it in. Then, pull upwards on the shoulder belt so that the lap belt gets tight around the car seat.

Grab the sides of the seat at the belt path and slide the seat side to side and front to back. The seat should not move more than 1" (2.5 cm).

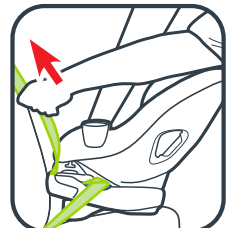
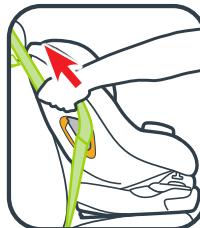
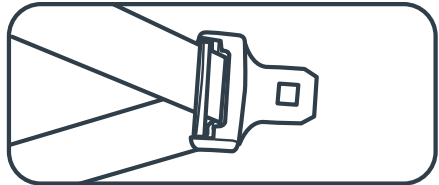
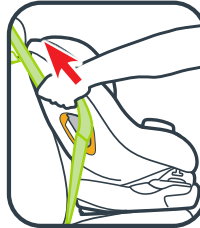
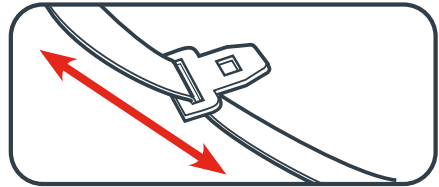

Sliding Latch Plate and ALR Retractor

A latchplate that slides freely on the belt webbing and cannot, by itself, hold the belt snug around a car seat.

Slowly pull the shoulder belt all the way out. Route the vehicle seat belt through the proper belt path and buckle it in. Then, as you pull the vehicle seat belt tight, feed all the slack back into the retractor.

Grab the sides of the seat at the belt path and slide the seat side-to-side and front-to-back. The seat should not move more than 1" (2.5 cm).

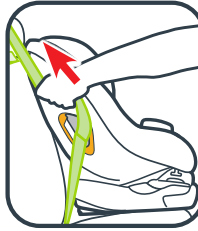
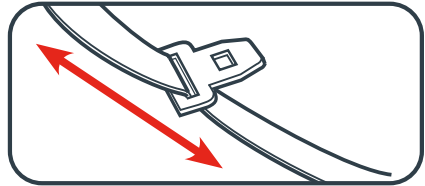

Sliding Latch Plate and ELR Retractor

A latchplate that slides freely on the belt webbing and cannot, by itself, hold the belt snug around a car seat.

With this retractor, you will need to use the locking clip to lock the vehicle seat belt.

Call us at 1-800-241-1848 to order a locking clip.

Route the vehicle seat belt through the proper belt path and buckle it in. Pull the vehicle seat belt tight. While pushing down on seat, pinch the two straps together behind the buckle tongue. Unbuckle the belt without allowing it to slip.

Attach locking clip to lap and shoulder belts as shown.

Rebuckle belt. Check that lap belt does not move by pulling hard. If belt loosens or lengthens, repeat procedure.

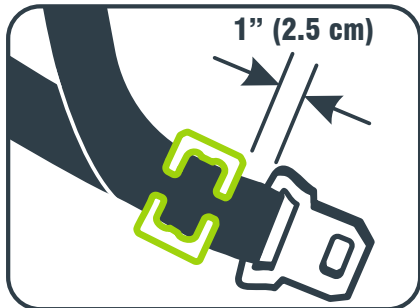
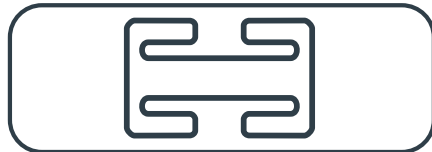
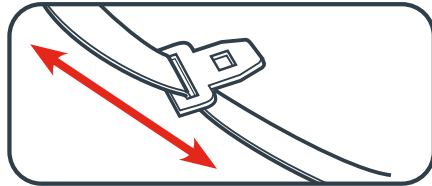

LAP BELT INSTALLATION

Always review your vehicle owner's manual for specific information about your vehicle seat belts.

Locking Latch Plate and No Retractor

When installing the car seat, route the lap seat belt through the proper path and buckle it in. Then, pull upwards on the tail of the belt so that the lap belt gets tight around the car seat.

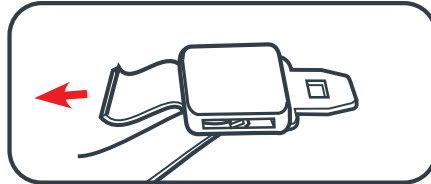

Grab the sides of the seat at the belt path and slide the seat side to side and front to back. The seat should not move more than 1" (2.5 cm).

Sewn On Latch Plate and ALR Retractor

Slowly pull the lap belt all the way out. Route the vehicle seat lap belt through the proper belt path and buckle it in. Then, pull the lap belt tight while feeding all the slack back into the retractor.

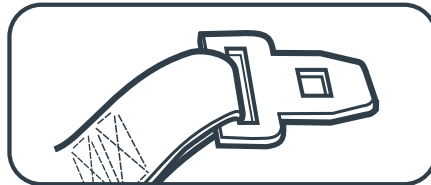

Grab the sides of the seat at the belt path and slide the seat side to side and front to back. The seat should not move more than 1" (2.5 cm).

CLEANING SEAT PAD

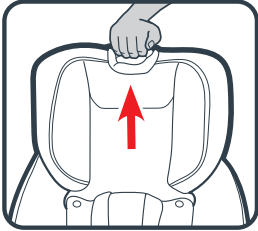

Clean the seat pad with a damp sponge using mild soap and cool water. Refer to seat pad care tag for washing instructions.

Headrest Pad

If needed, headrest pad may be removed for cleaning.

To remove, first raise the headrest to its highest position.

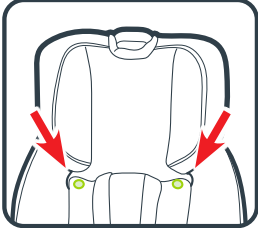

Then unsnap the two snaps under the headrest

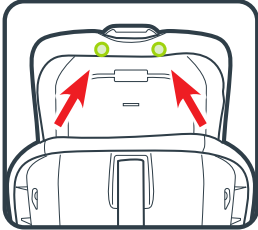

Undo the two snaps behind the headrest.

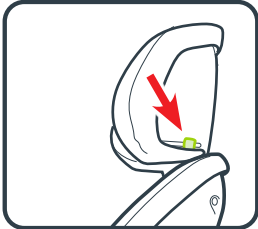

Undo the elastic straps on the sides of the headrest.

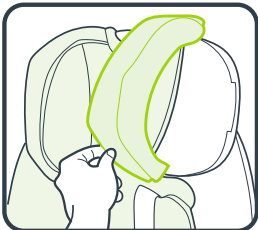

Pull pad off of headrest.

Machine wash cover in cold water on delicate cycle and drip-dry.
DO NOT USE BLEACH.

Reverse the steps to reattach the pad on the headrest.

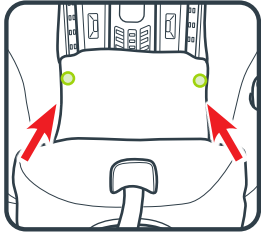

Seat Pad

If needed, the seat pad may be removed for cleaning.

To remove, unsnap the two snaps in the seat.

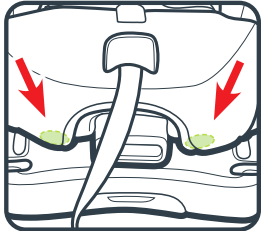

Then, pull out the two plastic buttons on the front of the car seat.

Note: You may have to rotate the seat to access the two buttons.

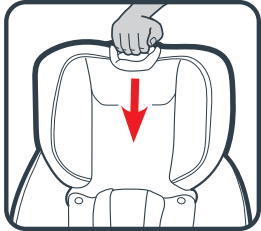

Lower the headrest to its lowest position.



Undo the two snaps at the top of the seat shell.

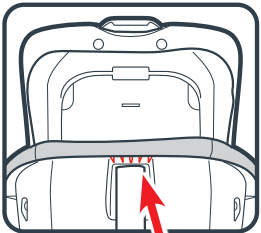

Remove the edge of the pad fabric from the ribs at the top of the seat.

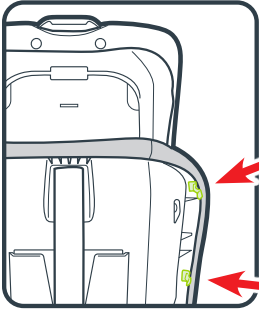

Remove the edges of the pad fabric from the 4 clips found inside the car seat shell lip

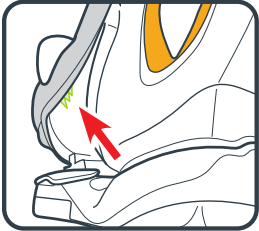
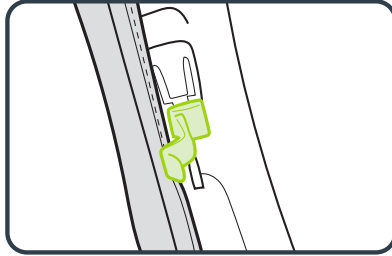

Remove the edges of the pad fabric from the ribs on lower sides of the seat.

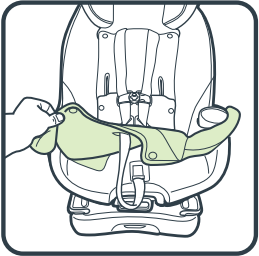

Pull the pad off.

Machine wash cover in cold water on delicate cycle and drip-dry. DO NOT USE BLEACH.

Reverse the steps to reattach the seat pad.

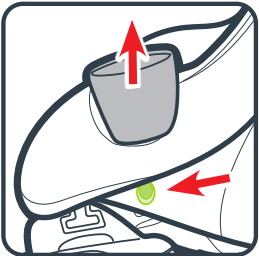

Cup Holder

If needed, cup holder may be removed for cleaning.

To remove the cup holder, push in the button located underneath the cup holder while pulling up on the cup holder.

Cup holder may be washed **ONLY** on the top rack of the dishwasher.

CARE AND MAINTENANCE

Cleaning the Seat Pad:

Refer to the care tag on your seat pad for washing instructions. NEVER use carrier without the seat pad attached.

Cleaning the Shell:

Spot clean using warm water and mild soap. Do not use any other cleaning agents or bleach.

Cleaning the Harness Straps:

Spot clean with mild soap and damp cloth. DO NOT SOAK straps in water as this may weaken them.

Cleaning the Buckle:

Remove buckle to clean

Rotate the car seat and locate the metal retainer on the underside of the seat shell. Rotate the metal retainer up through the shell and pad. From the front, pull out the buckle.

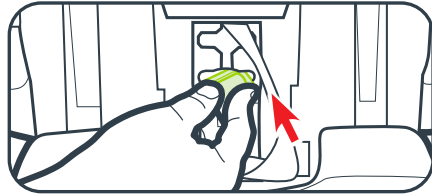
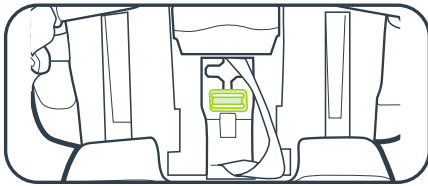

To clean, place in a cup of warm water and gently agitate the buckle. Press the red button several times while in the water.

DO NOT SUBMERGE THE BUCKLE STRAP. DO NOT USE SOAPS, HOUSEHOLD DETERGENTS or LUBRICANTS.

Shake out excess water and allow to air dry. Repeat steps as needed until it fastens with a click. Re-insert the buckle into the same slot it was removed. Pull up on crotch buckle to make sure it is secured.

WARNING! Inspect and clean buckle from time to time to remove any objects or debris that could prevent latching.

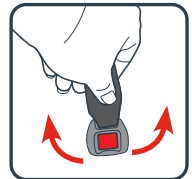

CLEANING HARNESS AND LOWER ANCHOR STRAPS

Surface wash only with mild soap and damp cloth. **DO NOT IMMERSE THE HARNESS STRAPS or LOWER ANCHOR STRAP IN WATER** Doing so may weaken the straps.

If harness straps or lower anchor attachment belt are frayed or heavily soiled, contact Customer Service at www.babyjogger.com or 1-800-241-1848.

LIMITED WARRANTY

This product is warranted against defective materials or workmanship for one year from the date of original purchase. Proof of purchase is required.

The warranty does not include:

- Normal wear and tear
- Corrosion or rust
- Incorrect assembly or the installation of third party parts or accessories not compatible with the original design.
- Accidental or intentional damage, abuse, or neglect
- Commercial use
- Improper storage/care of the unit

This warranty specifically excludes claims for indirect, incidental, or consequential damages. The implied warranties of merchantability and fitness for a particular purpose is according to the specific warranty period for this model unit at time of purchase.

Some states do not allow the exclusion or limitation of incidental or consequential damages, so the above limitations or exclusions may not apply to you. This warranty gives you specific legal rights and you may also have other rights which vary from state to state. To know what your legal rights are in your state, consult your local or state consumer affairs office or your state's Attorney General.

Note: When contacting Baby Jogger regarding your product, please have the serial number and manufacturing date ready. It can be found on the back of the car seat.

Consumer Care Contact Information:

Email: customerservice@babyjogger.com
Call: 1-800-241-1848
between 8:30am-5:30pm EST Mon-Fri
Mail: Baby Jogger, LLC
4110 Premier Drive
High Point, NC 27265

REPLACEMENT PARTS

To purchase parts or accessories in the United States,
please contact us at the following:

www.babyjogger.com

or

1-800-241-1848



Store instruction manual in
the slot with the instruction
book icon as shown.

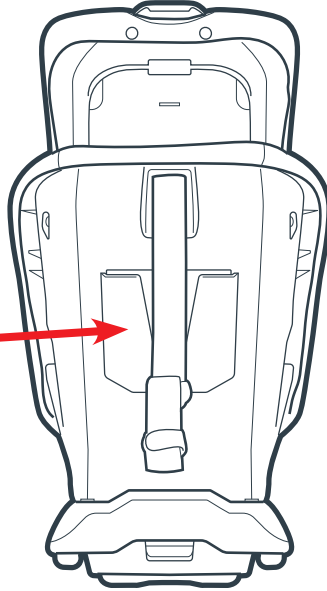

baby
jogger®

Baby Jogger, LLC

A newell BRANDS Company

6655 Peachtree-Dunwoody Rd. NE • Atlanta, GA 30328

www.babyjogger.com