

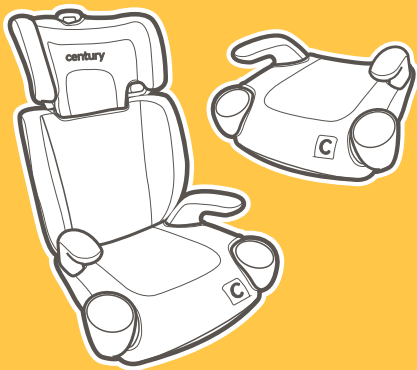

[www.centurybaby.com](http://www.centurybaby.com)

# Boost On™

## 2-in-1 Slim High Back Booster



century

### READ THIS INSTRUCTION MANUAL

Do not install or use this child restraint until you read, understand and follow the instructions in this manual and the warnings on the car seat.

**FAILURE TO PROPERLY USE THIS CHILD RESTRAINT INCREASES THE RISK OF SERIOUS INJURY OR DEATH IN A SUDDEN STOP OR CRASH.**

KEEP INSTRUCTIONS FOR FUTURE USE.

© Century Children's Products 2021  
NWL0001279521D 9.21

## **1 Important**

*Pages 4-17*

---

- 1-A Quick Guide to Your Manual
- 1-B Welcome to the Century Family!
- 1-C Before You Begin
- 1-D Safety Warnings

## **2 Features**

*Page 18*

---

## **3 Booster**

*Pages 19-32*

---

- 3-A Booster Use
- 3-B Install Highback Booster
- 3-C Install Backless Booster
- 3-D Securing Child Highback Booster
- 3-E Securing Child Backless Booster
- 3-F Using Belt Positioning Clip



## **4 Vehicle Information**

---

*Pages 33-36*

4-A Choosing a Vehicle Seat Location

4-B Unsafe Vehicle Seat Locations

4-C Vehicle Seat Belts

## **5 Care & Cleaning**

---

*Pages 36-41*

***This booster seat is for children:***

***Highback Booster: 40-100 lb (18.1-45 kg) and at least 4 years old***

***Backless Booster: 40-120 lb (18.1-54 kg) and at least 4 years old***

### ***Install Cup Holders***

#### ***Adult Assembly Required***

The cup holders must be installed.  
To attach the cup holders, match the right cup holder to the right side of the seat and the left to the left.

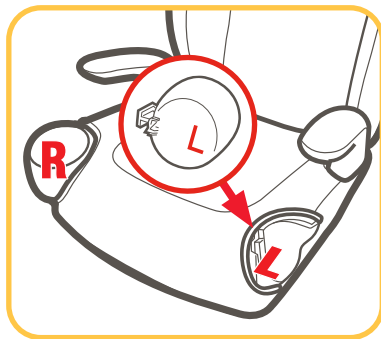

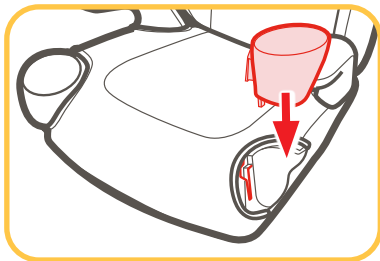
**C****1**

Slide the hook on the cup holder into the slot in the seat until you hear a “Click”. **You will hear a “Click” when they are secured in place.**

If needed, cup holder may be removed for cleaning. To remove cup holders, pull up on the cup holder.

Cup holders are dishwasher-safe (Top Rack Only).

### ***Install Head Support***

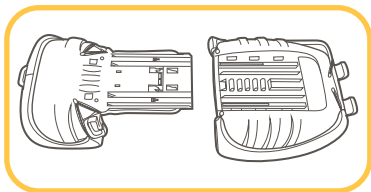

Flip head support and lower back support over as shown.

**1****C****C****C****C****C**

Slide two pieces together until they snap into place.

**CHECK** to make sure two pieces are securely snapped together by pulling on them.

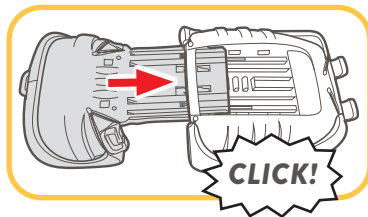

### ***Head support pad***

Flip seat over and insert the fabric from the head support underneath the fabric on the lower back support as shown.

To make insertion of fabric easier, slide the head support and back support pieces apart by pulling the yellow head support height adjustment lever.

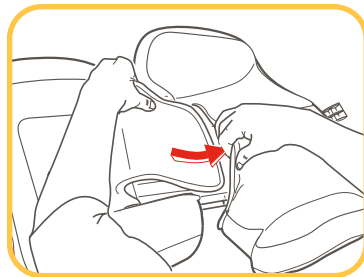

## *Install Back support*

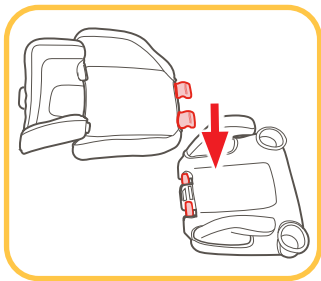

Connect the “U”-shaped hooks on bottom of the back support to the bars on the base until the hooks click into place.

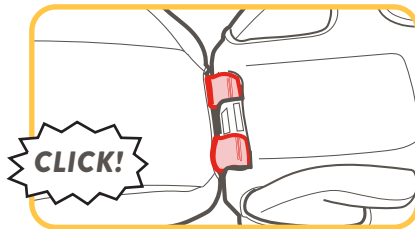

1

C

C

C

C

C

Once the “U”-shaped hooks on bottom of the seat back are hooked on the bars on the base, raise the back support until it is fully upright and you hear a “CLICK”.



Your Century booster seat is now ready to use!





## ***Get to Know Your Booster seat***

Review section 2 to see all of the features of this booster seat.

## ***What Seating Location Should I Use?***

***The best seating location for this booster seat is one that:***

- Is recommended by your vehicle owner's manual.
- Results in a secure installation of this booster seat.

Some vehicles have specific requirements for where the car seat can be installed, so be sure to check your vehicle owner's manual for available seating positions, if any.

Review section 4 of this manual AND your vehicle owner's manual.

According to accident statistics, children are safer when properly restrained in the rear seating positions than in the front seating positions. The center of the back seat can be the safest during a possible side impact.



### ***Using This Booster seat Correctly***

To make sure your child is secured properly, review section 3 to fit your child.

### ***When Installing***

#### ***Vehicle Seat Belt***

There is one type of vehicle seat belt that can be used:  
Lap/Shoulder Seat Belt.  
Review section 3 of this manual AND your vehicle owner's manual.

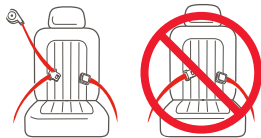

## Booster Installation

### **Never Use Lap Belt Only**

Review section 3

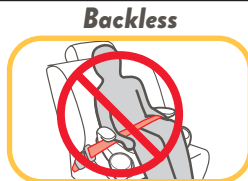

### **Lap Belt Underneath Armrest and Lies Low Across Hips and Thighs**

Review section 3



### **Shoulder Belt Lies On the Shoulder, Between the Neck and Edge of Shoulder**

Review section 3





1

## 1-B | Welcome to the Century Family!



Your child's safety depends on you. No car seat can guarantee protection from injury in every situation, but proper use helps reduce the risk of serious injury or death. Even if this booster seat seems easy to figure out on your own, you must follow the detailed instructions in this instruction manual to ensure all steps are performed correctly.

**Visit: [www.centurybaby.com/safety](http://www.centurybaby.com/safety) for more information about Century's car seat safety standards.**



## **Register This Child Restraint**

Please fill out the prepaid registration postcard attached to the seat pad and mail it in today **or register online at:**

**[www.centurybaby.com/carseatregistration](http://www.centurybaby.com/carseatregistration)**

Child restraints could be recalled for safety reasons. You must register this restraint to be reached in a recall. Send your name, address, and the restraint's model number and manufacturing date to:

Century Children's Products

Attn: Customer Service

P.O. Box 169, Elverson, PA 19520-9901

or call 1-844-385-0249

**or register online at**

**[www.centurybaby.com/carseatregistration](http://www.centurybaby.com/carseatregistration)**

For recall information, call the U.S. Government's Vehicle Safety Hotline at 1-888-327-4236 (TTY: 1-800-424-9153), or go to <http://www.NHTSA.gov>.

**1****C**

For future reference or if you change addresses, record the model name, model number, date of manufacture, and purchase date of this booster seat below. You can find this information either on the registration card if you still have it or on the date label located on the bottom of the booster seat.

**Model Name** \_\_\_\_\_

**Model Number** \_\_\_\_\_

**Date of Manufacture** \_\_\_\_\_

**Date of Purchase** \_\_\_\_\_

### ***If You Need Help***

In the U.S.A, please contact our Customer Service Department with any questions you may have concerning parts, use, or maintenance. When you contact us, please have your product's model number and date of manufacture ready so that we may help you efficiently. These numbers can be found on a sticker on the bottom of your booster seat.

For additional resources or to get your booster seat checked by a child passenger safety technician, please visit the following web sites:

[www.nhtsa.gov](http://www.nhtsa.gov) • [www.seatcheck.org](http://www.seatcheck.org) • [www.safekids.org](http://www.safekids.org)

### **Certification**



This child restraint meets or exceeds all applicable requirements of Federal motor vehicle safety standard 213 for use in motor vehicles.

This child restraint is not certified for aircraft use when used as a booster seat because aircrafts do not have shoulder belts. Contact the airline for their specific polices.

### **Booster seat's Useful Life**

**DO NOT** use this child restraint 10 years after the date of manufacture. Look for date of manufacture label on bottom of the booster seat.

Century Children's Products advises against loaning or passing along a car seat unless you know the complete history of the product. We also advise against purchasing a car seat second hand.

### **Vehicle Seat Protection**

Protect the vehicle seat. Use a car seat mat, towel, or thin blanket under and behind the booster seat.

### *Warm Weather Use*

Car seat parts can get very hot in the sun or warm weather. To avoid burns, always check before putting child in booster seat.

## 1-D | Safety Warnings

**No car seat can guarantee protection from injury in every situation, but proper use helps reduce the risk of serious injury or death. READ THIS MANUAL CAREFULLY.**

### **⚠ WARNING!**

Failure to follow these instructions and child restraint's labels can result in child striking the vehicle's interior during a sudden stop or crash.



- ! Review your vehicle owner's manual for more information about air bags and car seat use.**
- ! If your vehicle does not have a back seat, review your vehicle owner's manual.**
- ! Select a suitable location for the booster seat in your vehicle.**
- ! Always secure booster seat with the vehicle seat belt, even when unoccupied. In a crash, an unsecured car seat can injure passengers.**
- ! If booster seat is in a crash, it must be replaced. DO NOT use it again! A crash can cause unseen damage and using it again could result in serious injury or death.**
- ! DO NOT use booster seat if it is damaged or missing parts.**
- ! DO NOT use accessories or parts other than those provided by Century except for a thin towel or mat to protect your vehicle seat. Their use could alter the performance of the car seat.**
- ! Never leave child unattended, even when sleeping. Child may become tangled in harness straps and suffocate or strangle.**

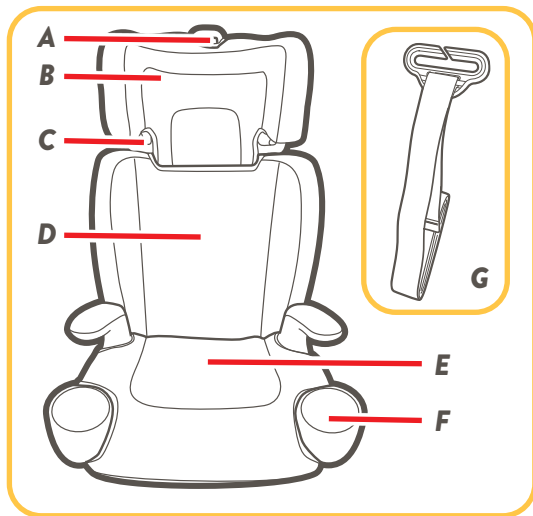

*A Head Support Adjustment Lever*

*B Head Support*

*C Shoulder Belt Guide*

*D Back Support*

*E Seat Base*

*F Cup Holder*

*G Belt Positioning Clip (Inset)*

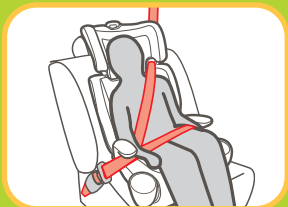

**Vehicle Lap/Shoulder  
Seat Belt**



**Vehicle Lap/Shoulder  
Seat Belt**

**Booster Use With Back:**  
40-100 lb (18.1-45 kg) 43-57 in.  
(110.1-145 cm) at least 4 years old



**Booster Use Without Back:** 40-120  
lb (18.1-54 kg) 43-57 in. (110.1-145 cm) at least  
4 years old

- Place booster seat forward-facing in the vehicle back seat.
- Make sure vehicle seat's lap belt is adjusted snugly and lays low on the child's hip and is routed under the armrest in the booster's belt path.
- Vehicle belts **MUST** lie flat against child and **MUST NOT** be twisted.
- Vehicle seat's shoulder belt is adjusted snugly and should lie between child's neck and edge of shoulder.

- Never use a vehicle lap-only belt across front of child.
- **DO NOT** position vehicle shoulder belt under the child's arm or back.
- **DO NOT** allow child to slouch or slide down in the booster seat.
- **DO NOT** position vehicle belt over top of armrests.
- Vehicle's seat head support **SHOULD NOT** create a gap between vehicle seat and booster seat.
- The front of booster seat **MUST NOT** hang over front of vehicle seat.
- If child will not keep vehicle belt properly positioned, **DO NOT** use this booster seat. Use a different car seat.



**Never Use a Vehicle Lap-Only Belt Across Front of Child**

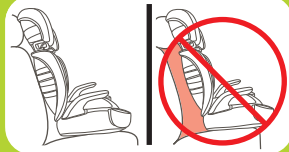



### 1. Place Booster seat *Forward-Facing* in *Back Seat of the Vehicle*

Place forward-facing on a vehicle seat that has a lap/shoulder seat belt. The base should sit as flat as possible on the vehicle seat.

Make sure the base **completely** rests on the vehicle seat. The front of booster seat **MUST NOT** hang over the front of vehicle seat.



### 2. Thread the Vehicle Seat Shoulder Belt Through Seat Belt Guide on the Head support

See section 3-D to secure your child.

# 3

## 3-C | Install Backless Booster

# C

### 1. Remove the Back Support

Recline the back support all the way then remove from the base.

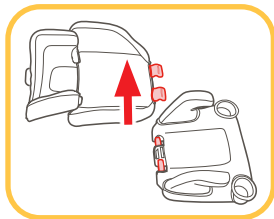

### 2. Place the Booster Seat Forward-Facing in the Back Seat of Vehicle

Place forward-facing on a vehicle seat that has a lap/shoulder seat belt. The base should sit as flat as possible on the vehicle seat.

See section 3-E to secure your child.

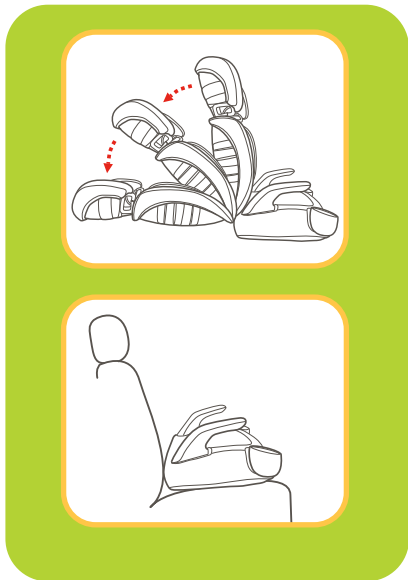

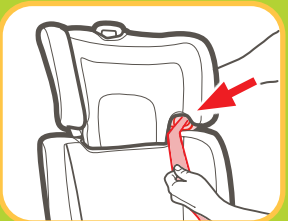
**! WARNING!**

Use only the vehicle lap and shoulder belt system when restraining the child in the booster seat.

**1. Place Child In Seat**

Have your child sit in the booster seat, with his/her back flat against the back of the booster seat.

**2. Thread Vehicle's Shoulder Belt Into Seat Belt Guide in the Head support**

### 3. To Raise or Lower Head support Support

Lift adjustment lever and lift or lower head support. The belt guides should be even with or just above the shoulders.

Check to make sure the head support is securely locked into one of the 6 height positions by pulling up on head support.

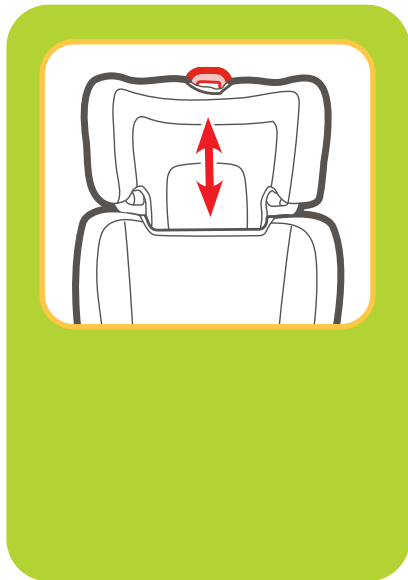



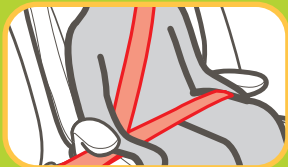
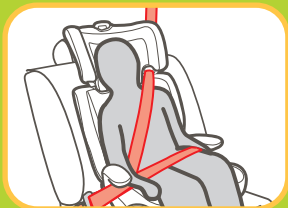

#### **4. Buckle the Vehicle Lap/Shoulder Seat Belt**

Be sure the lap portion of the vehicle seat belt goes under both armrests and the shoulder belt goes under the armrest on the buckle side.

Be sure the lap portion of the vehicle seat belt lies low across your child's hips.

Be sure the shoulder belt lies across your child's shoulder, between the neck and edge of shoulder.

# 3 Is Everything Correct?



*Never Use Lap Belt Only*

*Lap Belt Underneath Armrest and Lies Low Across Hips and Thighs*

*Shoulder Belt Lies On the Shoulder, Between the Neck and Edge of Shoulder*

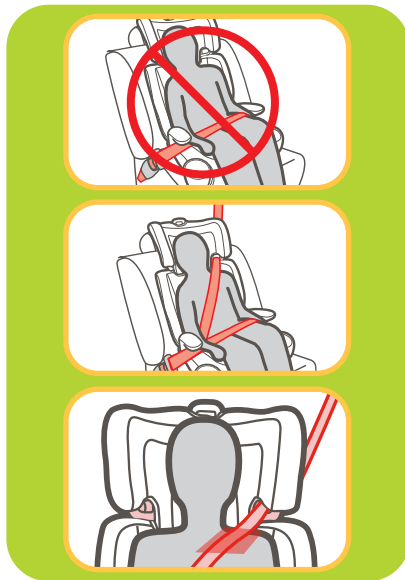

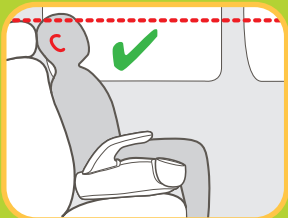
**! WARNING!**

Use only the vehicle lap and shoulder belt system when restraining the child in the booster seat.

**1. Place Child In Seat**

Have your child sit in the booster seat, with his/her back flat against the back of the vehicle seat.

**2. Ears Must Be Below the Top of the Vehicle Seat Back or Head support.**

### 3. Buckle the Vehicle Lap/Shoulder Seat Belt

Be sure the lap portion of the vehicle seat belt goes under both armrests and the shoulder belt goes under the armrest on the buckle side.

Be sure the lap portion of the vehicle seat belt lies low across your child's hips.

Be sure the shoulder belt lies across your child's shoulders, between the neck and edge of shoulder.

**You may need to use the belt positioning clip to help get a good fit. See section 3-F "Using Belt Positioning Clip"**

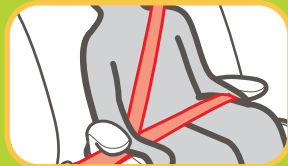
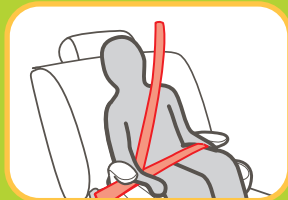



***Never Use Lap Belt Only***

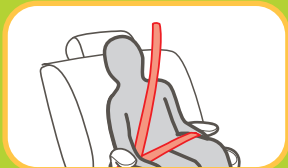

***Lap Belt under Armrest and Lies Low Across Hips and Thighs***



***Shoulder Belt Lies On the Shoulder, Between the Neck and Edge of Shoulders***

# 3

## 3-F | Using Belt Positioning Clip

# C

### 1. Make Sure Vehicle's Seat Shoulder Belt Lays Between The Neck And Edge Of Shoulder As Shown

If the vehicle's seat shoulder belt lays outside this zone, you **MUST** use the belt positioning clip. **DO NOT** use the belt positioning clip if the shoulder belt is already in the red zone.

### 2. Attach Belt Positioning Clip

The shoulder belt positioning clip **MUST** be attached to the slot on the back of the base. Insert the loop end of strap through the slot on back of seat exactly where shown.

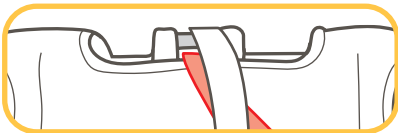

### 3. Push Clip and Strap Through Loop

Pass the clip and the strap through the loop end as shown and pull strap up.

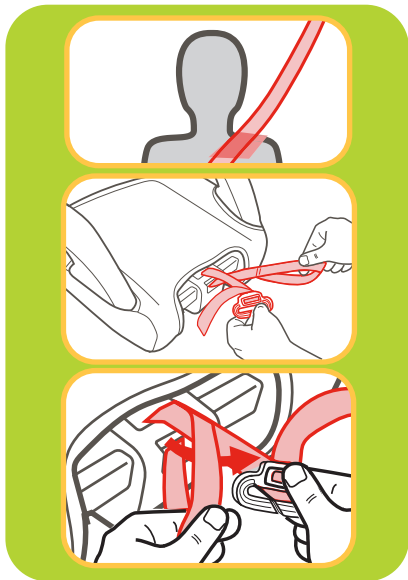

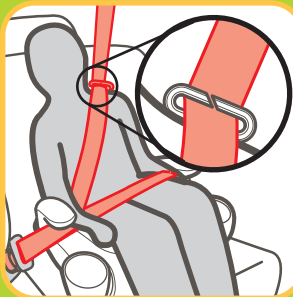
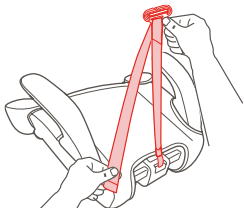

#### **4. Free End of Strap Should Face Front of Seat**

#### **5. Place Child in Seat, Buckle Child In Seat and Attach Belt Positioning Clip**

With child's back flat against the back of the vehicle seat, buckle child in. Then slide the clip onto the vehicle's seat shoulder belt as shown.

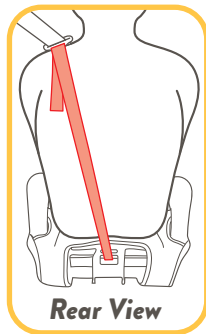

## 6. Adjust the Belt Positioning Clip to Fit Your Child

Lengthen or shorten the belt length as shown.

Clip should fit right at the top of shoulder as shown.

Be sure the lap portion of the vehicle seat belt lies low across your child's hips.

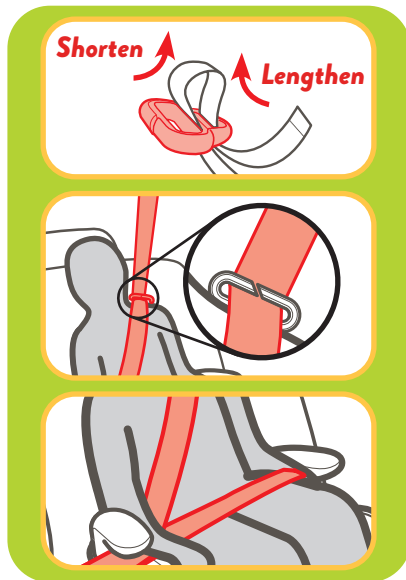



***Review your vehicle owner's manual for seating locations.***

***The best seating location for this booster seat is one that:***

- Is recommended by your vehicle owner's manual, and
- Results in a secure installation of this booster seat

In the event there is no available back seat and / or you have no other option than to place a child in a front passenger seating position, the National Highway Traffic Safety Administration (NHTSA) recommends that you take the following steps:

- Ensure the child is properly restrained according to their age and size
- Move the seat as far back as possible
- Make sure the child is not leaning out of position, such as leaning forward into the deployment path of the air bag
- Set the air bag ON-OFF switch, if available, to the OFF position

Never install this booster seat in any of the following vehicle seating locations:



rear-facing or side-facing  
vehicle seats



booster mode with vehicle lap  
belt only seat belt



## 4-C | Vehicle Seat Belts



*Review your vehicle owner's manual for vehicle seat belt use*

### **Vehicle Seat Belt Terms**

#### **Retractor**

A device that winds up the unused vehicle seat belt. It is often hidden inside the panels on the walls of the vehicle or in the vehicle seat back.

#### **Latch Plate**

The male end of the seat belt with the silver tongue.

#### **Seat Crease**

The crease where the vehicle seat back and seat bottom meet.

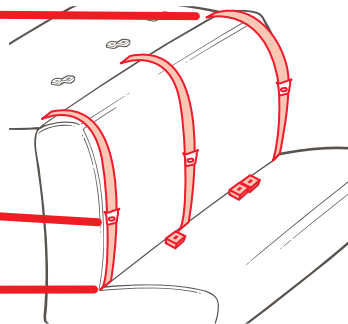



## Identify Your Seat Belt Type

There is one type of vehicle seat belt that can be used with this booster seat:

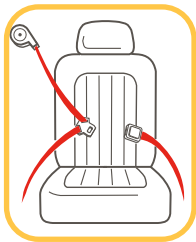

**LAP/SHOULDER BELT**  
3 connections points.

The following types of vehicle seat belts **CANNOT** be used safely with this booster seat:



Lap Belt Only 2 connection points.



Lap Belt with Motorized Shoulder Belt



Lap Belt or Shoulder Belt Mounted on Door



Belts Forward of the Seat Crease

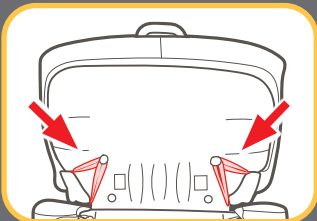
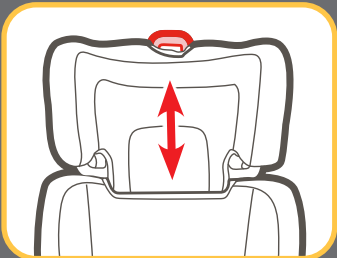

**Refer to seat pad care tag for washing instructions.**

### **Head Support Pad**

Clean with a damp sponge using mild soap and cool water. If needed, pad may be removed for cleaning.

To remove head support cover, raise the head support to the highest position.

Undo the 4 elastic loops on the back of the head support. Then remove the head support cover.



Machine wash pad in cold water with gentle soap on delicate cycle and drip-dry. **DO NOT USE BLEACH.**

To put the head support pad back on, reverse preceding steps.

When reinstalling the head support pad, remember to insert the fabric from the head support underneath the fabric on the lower back support as shown.

To make insertion of fabric easier, slide the head support and back support pieces apart by pulling the yellow head support height adjustment lever.

### **Back Support Pad**

Undo the 2 upper elastic loops on the back of the back support.

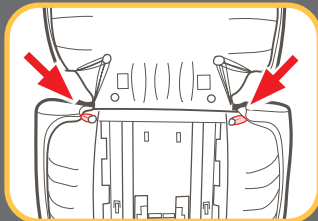
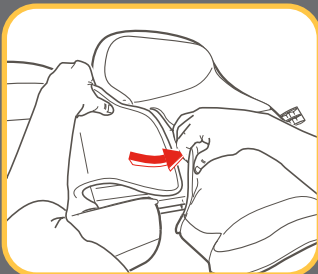

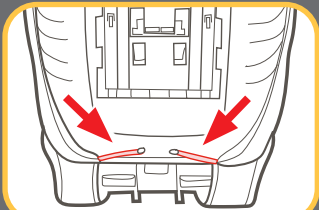

Undo the 2 lower elastic loops on the back of the back support.

Machine wash pad in cold water with gentle soap on delicate cycle and drip-dry. **DO NOT USE BLEACH.**

To put the back support pad back on, reverse preceding steps.



### **Seat Base Pad**

Recline the back support all the way then remove from the base.

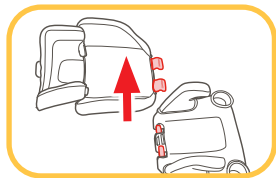

The seat back pad is held in place with 2 attachment tabs.

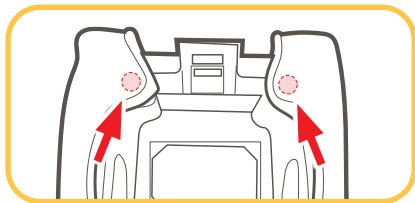

To remove an attachment tab, pull the fabric near the attachment tab diagonally toward the center of the base, then lift the fabric away.

Machine wash pad in cold water with gentle soap on delicate cycle and drip-dry. **DO NOT USE BLEACH.**

To put the seat base pad back on, reverse preceding steps.

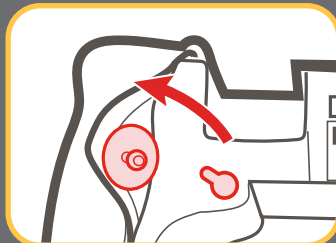
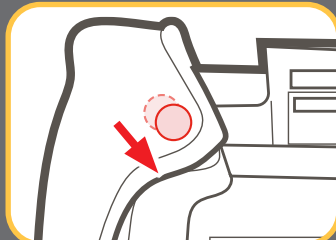

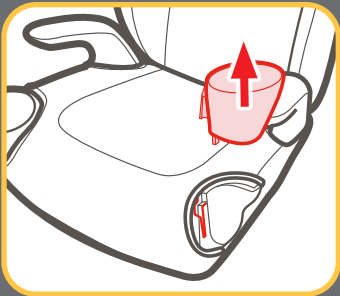

**C****5**

### ***Cup Holder***

If needed, cup holder may be removed for cleaning. To remove cup holders, pull up on the cup holder.

Cup holders are dishwasher-safe (Top Rack Only).



# Notes



# Notes

# Replacement Parts

To purchase parts or accessories in the United States,  
please contact us at the following:

**[www.centurybaby.com](http://www.centurybaby.com)**  
or  
**1-844-385-0249**

---

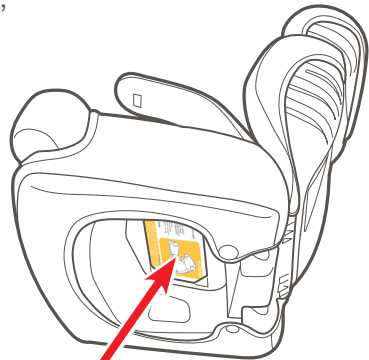

Store instruction manual  
in the slot with the  
instruction book icon as  
shown.

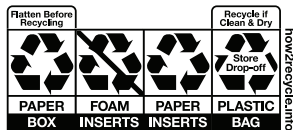

As part of our Do More promise, we encourage everyone to recycle or reuse their cartons and packaging. See below for recycling instructions (from our expert friends at the How2Recycle coalition!) or visit [www.centurybaby.com/domore](http://www.centurybaby.com/domore) for other ideas!