

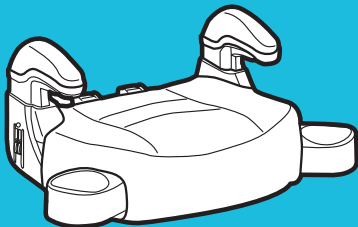

www.gracobaby.com

TURBOBOOSTER 2.0

Read This Instruction Manual



Do not install or use
this child restraint until you read
and understand the instructions in
this manual.

**FAILURE TO PROPERLY USE THIS
CHILD RESTRAINT INCREASES
THE RISK OF SERIOUS INJURY
OR DEATH IN A SUDDEN STOP OR
CRASH.**

NWL0001463536A 8/22

1 Important

Pages 4-15

- 1-A Quick Guide to Your Manual
- 1-B Welcome to the Graco Family
- 1-C Before You Begin
 - Register This Child Restraint
 - If You Need Help
 - Certification
 - Car Seat's Useful Life
 - Vehicle Seat Protection
 - Warm Weather Use
- 1-D Safety Warnings

2 Features

Page 16

3 Booster

Pages 17-19

- 3-A Booster Use
- 3-B Install Backless Booster

4 Securing Child

Pages 20-25

5 Accessories

Page 26

6 Vehicle Information

Pages 27-30

- 6-A** Choosing Vehicle Seat Location
- 6-B** Unsafe Vehicle Seat Location
- 6-C** Vehicle Seat Belts

7 Care & Cleaning

Pages 31



1 Important

1-A Quick Guide to Your Manual

This car seat is for children: **Booster: 40-100 lb (18.1-45 kg) 43-57 in (110.1-145 cm) at least 4 years old**

Car Seat Assembly (On Select Models)

Adult Assembly Required **1. Armrests**

Insert armrest into base as shown until buttons snap into slots on side of base. Select the desired armrest height for your child, then insert the height adjustment screw and tighten. Repeat for other armrest.

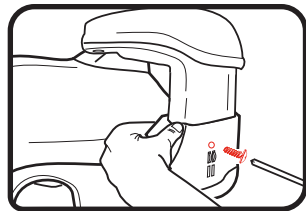
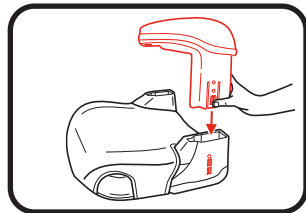

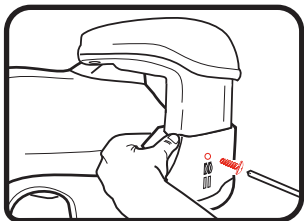

To adjust armrests, remove screw and press in button on side of base as shown to raise or lower. Reinsert screw and tighten. **CHECK** to make sure armrests are securely attached by pulling up on them.

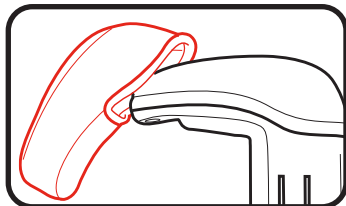
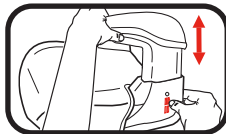

2. Armrest Covers

Slip armrest covers onto armrests as shown.
(on certain models)

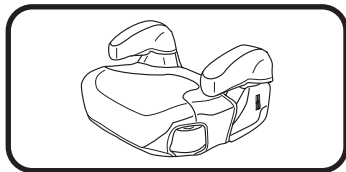

Your Graco booster seat is now ready to use.



1 Important

Get to Know Your Car Seat

Review section 2-A to see all of the features of this booster seat.

What Seating Location Should I Use?

The best seating location for this booster seat is one that:

- Is recommended by your vehicle owner's manual, and
- Results in a secure installation of this booster seat.

Some vehicles have specific requirements for where the booster seat can be installed, so be sure to check your vehicle owner's manual for available seating positions, if any. For example, sometimes the center rear seat has a lap belt only vehicle seat belt, which cannot be used with this booster seat.

Review section 6-B, 6-C, of this manual AND your vehicle owner's manual.

According to accident statistics, the safest place for your child in any vehicle is the back seat. The center of the back seat can be the safest during a possible side impact.



Using The Car Seat Correctly

To make sure your child is secured properly, review section 3 and 4 to fit your child.

When Installing As a Booster

Vehicle Seat Belt

There is one type of vehicle seat belt that can be used: Lap/Shoulder Seat Belt.

Review section 3 of this manual AND your vehicle owner's manual.

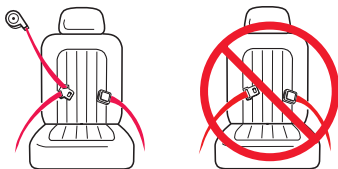

i
1 Important

i
1 Important

Booster Installation

Use Lap/Shoulder Belt Only

Review section 3

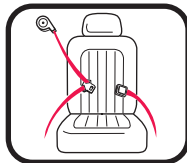

Position Lap Belt

Lap belt must go under armrest and lie low across your child's hips and thighs.

Review section 4

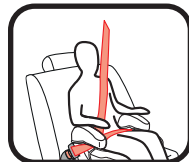

Position Shoulder Belt

Shoulder belt lies across shoulder between neck and edge of shoulder in the red zone as shown.

Review section 4

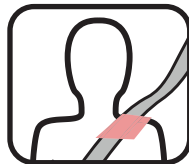

1-B Welcome to the Graco Family!

Your child's safety depends on you. No car seat can guarantee protection from injury in every situation, but proper use helps reduce the risk of serious injury or death. Even if this car seat seems easy to figure out on your own, you must follow the detailed instructions in this instruction manual to ensure the steps below are performed correctly.





1 Important

1-C Before You Begin

Register This Child Restraint

Please fill out the prepaid registration postcard attached to the seat pad and mail it in today **or register online at www.gracobaby.com/carseatregistration.**

Child restraints could be recalled for safety reasons. You must register this restraint to be reached in a recall. Send your name, address, and the restraint's model number and manufacturing date to:

Graco Children's Products, Inc.
Attn: Customer Service
P.O. Box 169, Elverson, PA 19520-9901

**or register online at www.gracobaby.com/carseatregistration
or call 1-800-345-4109**

For recall information, call the U.S. Government's Vehicle Safety Hotline at 1-888-327-4236 (TTY: 1-800-424-9153), or go to <http://www.NHTSA.gov>.

For future reference or if you change addresses, record the model name, model number, date of manufacture and purchase date of this car seat on the below. You can find this information either on the registration card if you still have it or on the date label located on the back of the car seat.

Model Name _____

Model Number _____

Date of Manufacture _____

Date of Purchase _____



1 Important

If You Need Help

In the U.S.A, please contact our Customer Service Department with any questions you may have concerning parts, use, or maintenance. When you contact us, please have your product's model number and date of manufacture ready so that we may help you efficiently. These numbers can be found on a sticker on the back side of your car seat.

For additional resources or to get your car seat checked by a child passenger safety technician, please visit the following web sites:

www.nhtsa.gov • www.seatcheck.org • www.safekids.org



1 Important

Certification

This child restraint meets or exceeds all applicable requirements of Federal motor vehicle safety standard 213 for use in motor vehicles.



This child restraint is NOT certified for aircraft use when used as a booster seat because aircrafts do not have shoulder belts.

Car Seat's Useful Life

STOP using this car seat and throw it away 10 years after the date of manufacture. Look for date of manufacture label on back of the car seat.

Graco Children's Products Inc. advises against loaning or passing along a car seat unless you know the complete history of the product. We also advise against purchasing a car seat second hand.

Vehicle Seat Protection

Protect vehicle seat. Use a car seat mat, towel, or thin blanket under and behind car seat.

Warm Weather Use

Car seat parts can get very hot in the sun or warm weather. **To avoid burns, always check before putting child in car seat.**

1-D Safety Warnings

No car seat can guarantee protection from injury in every situation, but proper use helps reduce the risk of serious injury or death. **READ THIS MANUAL CAREFULLY.**

!WARNING!

Failure to follow these instructions and child restraint's labels can result in child striking the vehicle's interior during a sudden stop or crash.



1 Important

- ! When forward-facing, children should use the built-in harness system for as long as possible until they reach the maximum forward-facing weight or height for their car seat. At that point, children should ride in a belt-positioning booster seat. A booster is no longer needed once the vehicle seat belt fits properly, typically when they reach 4 feet 9 inches (145 cm) tall and are between ages 8-12. Be sure to check your local and state laws, as well as AAP and NHTSA recommendations, for car seat usage.***
- ! Review your vehicle owner's manual for more information about air bags and car seat use.**
- ! If your vehicle does not have a back seat, review your vehicle owner's manual.**

*Graco Supports the American Academy of Pediatrics and National Highway Traffic Safety Administration's Car Seat Guidelines. Visit www.gracobaby.com/en-US/safety-information for information on car seat usage recommendations.

- ! Select a suitable location for the car seat in your vehicle.**
- ! Always secure car seat with the vehicle seat belt, even when unoccupied. In a crash, an unsecured car seat can injure occupants.**
- ! If car seat is in a crash, it must be replaced. DO NOT use it again! A crash can cause unseen damage and using it again could result in serious injury or death.**
- ! DO NOT use car seat if it is damaged or missing parts.**
- ! DO NOT use accessories or parts other than those provided by Graco except for a thin towel or mat to protect your vehicle seat. Their use could alter the performance of the car seat.**
- ! Never leave child unattended, even when sleeping.**

2-A Car Seat Features

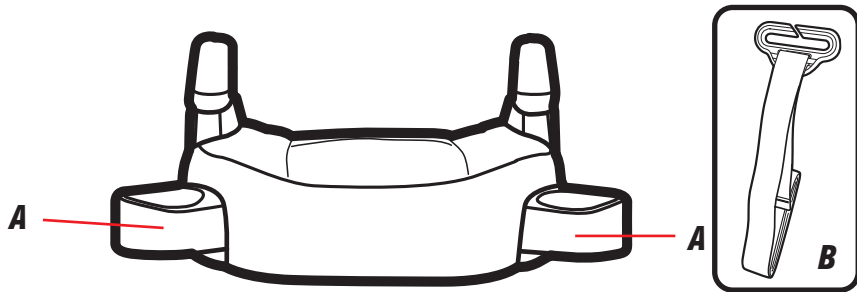

A *Cup Holder*

B *Belt Positioning Clip (Inset)*

3-A Booster Use

**Booster Use Without Back: 40-100 lb (18.1-45 kg)
43-57 in. (110.1-145 cm) at least 4 years old**

- Place car seat forward-facing in the vehicle back seat.
- Make sure vehicle seat's lap belt is adjusted snugly and lays low on the child's hip and is routed under the armrest in the booster's belt path.
- Vehicle belts **MUST** lie flat against child and **MUST NOT** be twisted.
- Vehicle seat's shoulder belt is adjusted snugly and should lie between child's neck and edge of shoulder.
- **DO NOT** position vehicle shoulder belt under the child's arm or back.



**Vehicle Seat Lap/
Shoulder Belt**



3 Booster

3 Booster



Never Use a Vehicle Lap-Only Belt Across Front of Child



- **Never** use a vehicle lap-only belt across front of child.
- **DO NOT** allow child to slouch or slide down in the booster seat.
- **DO NOT** position vehicle belt over top of armrests.
- The front of booster seat **MUST NOT** hang over front of vehicle seat.
- If child will not keep vehicle belt properly positioned, **DO NOT** use this booster seat. Use a different car seat.

When forward-facing, children should use the built-in harness system for as long as possible until they reach the maximum forward-facing weight or height for their car seat. At that point, children should ride in a belt-positioning booster seat. A booster is no longer needed once the vehicle seat belt fits properly, typically when they reach 4 feet 9 inches (145 cm) tall and are between ages 8-12. Be sure to check your local and state laws, as well as AAP and NHTSA recommendations, for car seat usage.

3-B Install Backless Booster

1. *Place the Booster Seat Forward-Facing in the Back Seat of Vehicle*

Place forward-facing on a vehicle seat that has a lap/shoulder seat belt. The base should sit as flat as possible on the vehicle seat.

See section 4-A to secure your child.



3 Booster

4-A Securing Child Backless Booster



4 Securing Child

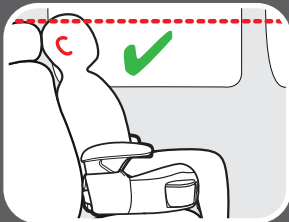

!WARNING!

Use only the vehicle lap and shoulder belt system when restraining the child in the booster seat.

1. Place Child In Seat

Have your child sit in the booster seat, with his/her back flat against the back of the vehicle seat.

2. Ears Must Be Below the Top of the Vehicle Seat Back or Headrest.

3. Buckle the Vehicle Lap/Shoulder Seat Belt

Be sure the lap portion of the vehicle seat belt goes under both armrests and the shoulder belt goes under the armrest on the buckle side.

Be sure the lap portion of the vehicle seat belt lies low across your child's hips.

Be sure the shoulder belt lies across your child's shoulders, in the red zone between the neck and edge of shoulder.

You may need to use the belt positioning clip to help get a good fit. See "Using Belt Positioning Clip"

21

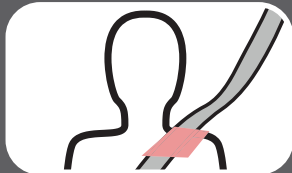

Is Everything Correct?

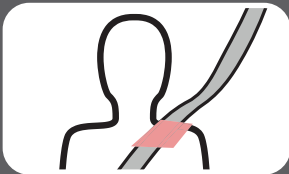
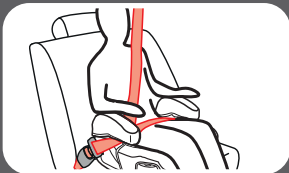

Never Use Lap Belt Only

Lap Belt under Armrest and Lies Low Across Hips and Thighs

Shoulder Belt Lies On the Shoulder, in the red zone Between the Neck and Edge of Shoulders

Using Belt Positioning Clip

1. Make Sure Vehicle's Seat Shoulder Belt Lays in the Red Zone As Shown

If the vehicle's seat shoulder belt lays outside this zone, you **MUST** use the belt positioning clip.

2. Attach Belt Positioning Clip

The shoulder belt positioning clip **MUST** be attached to the slot on the bottom of the base.

Insert the loop end of strap through the slot on bottom of seat exactly where shown.



3. Push Clip and Strap Through Loop

Pass the clip and the strap through the loop end as shown and pull strap up.

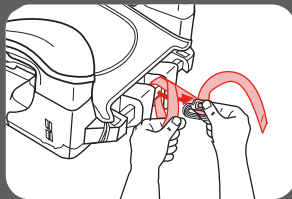
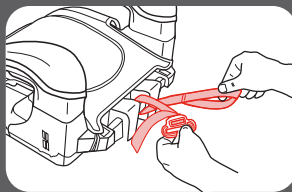
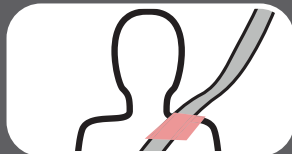

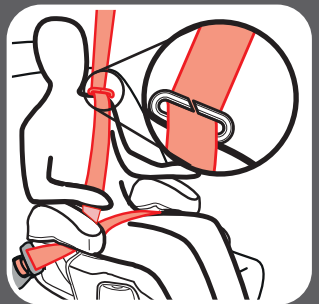
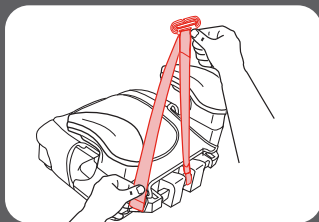

4. Free End of Strap Should Face Front of Seat

5. Place Child in Seat, Buckle Child In Seat and Attach Belt Positioning Clip

With child's back flat against the back of the vehicle seat, buckle child in. Then slide the clip onto the vehicle's seat shoulder belt as shown.

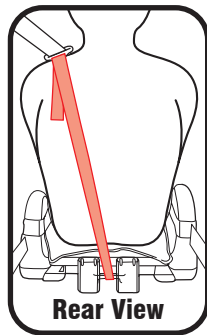

6. Adjust the Belt Positioning Clip to Fit Your Child

Lengthen or shorten the belt length as shown.

Clip should fit right at the top of shoulder as shown.

Be sure the lap portion of the vehicle seat belt lies low across your child's hips.

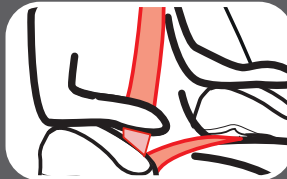
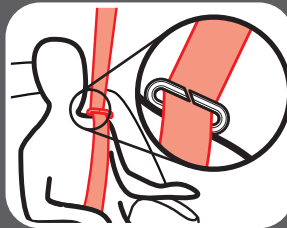
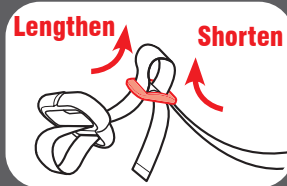

5 Accessories

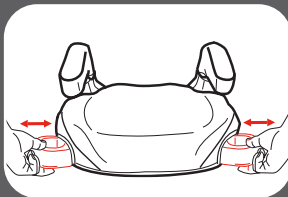

Cup Holders

6-A Choosing Vehicle Seat Location

Review your vehicle's owner manual for Seating Locations

The best seating location for this car seat is one that:

- Is recommended by your vehicle owner's manual, and
- Results in a secure installation of this car seat

In the event there is no available back seat and / or you have no other option, the National Highway Traffic Safety Administration (NHTSA) recommends that you take the following steps:

- Ensure the child is properly restrained according to their age and size
- Move the seat as far back as possible
- Make sure the child is not leaning out of position, such as leaning forward into the deployment path of the air bag
- Set the air bag ON-OFF switch, if available, to the OFF position





6-B Unsafe Vehicle Seat Location

Never install this car seat in any of the following vehicle seating locations:



rear-facing or side-facing
vehicle seats



booster mode with vehicle
lap belt only seat belt



6-C Vehicle Seat Belts

Review your vehicle's owner manual for vehicle seat belt use

Vehicle Seat Belt Terms

Retractor

A device that winds up the unused vehicle seat belt. It is often hidden inside the panels on the walls of the vehicle or in the vehicle seatback.

Latch Plate

The male end of the seat belt with the silver tongue.

Seat Bight

The crease where the vehicle seat back and seat bottom meet.

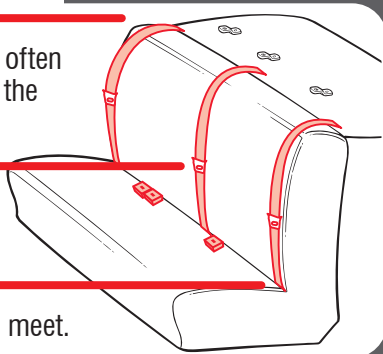



Identify Your Seat Belt Type

There is one type of vehicle seat belt that can be used with this car seat:

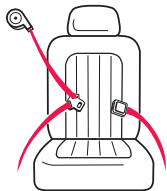

Lap/Shoulder Belt 3 connections points. Can be used in all car seats modes of use.



Belts Forward of the Seat Bight:

Some vehicles you may not get a secure fit. Read both your vehicle and car seat manuals.

The following types of vehicle seat belts **CANNOT** be used safely with this car seat:



Lap Belt Only 2 connection points.



Lap Belt with Motorized Shoulder Belt



Lap Belt or Shoulder Belt Mounted on Door

7-A Cleaning Seat Pad

Refer to seat pad care tag for washing instructions.

To Remove Seat Cover

Remove elastic loops and hooks from seat as shown.

Clean with a damp sponge using mild soap and cool water. If needed, head support cover may be removed for cleaning.

Machine wash cover in cold water on delicate cycle and drip-dry. **DO NOT USE BLEACH.**

To reattach the seat pad see section 1 and reattach elastic straps as shown.

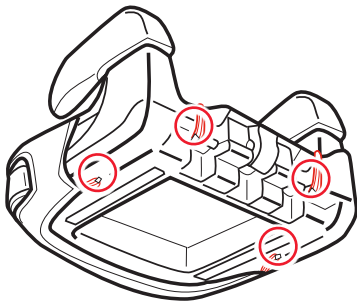

Replacement Parts

To purchase parts or accessories in the United States,
please contact us at the following:

www.gracobaby.com

or

1-800-345-4109



Store instruction manual in
the slot with the instruction
book icon as shown.

