

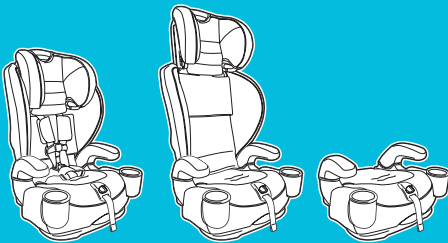

Nautilus[®] SnugLock[®] Grow[™]

3-in-1 Forward-Facing Harness Booster

Read This Instruction Manual



Do not install or use this child restraint until you read and understand the instructions in this manual.

FAILURE TO PROPERLY USE THIS CHILD RESTRAINT INCREASES THE RISK OF SERIOUS INJURY OR DEATH IN A SUDDEN STOP OR CRASH.

1 Important

Pages 6-23

1-A Quick Guide to Your Manual

1-B Welcome to the Graco Family

1-C Right Mode of Use

1-D Before You Begin

Register This Car Seat

If You Need Help

Certification

Car Seat's Useful Life

Vehicle Seat Protection

Warm Weather Use

1-E Safety Warnings

2 Features

Pages 24-29

3 Forward-Facing

Pages 30-49

3-A Forward-Facing Use

3-B Install Forward-Facing with LATCH

3-C Install Forward-Facing with the Vehicle Seat Belt

4 Securing Child

Pages 50-56

4-A Securing Child 5-Point Harness

5 Booster

Pages 57-82

- 5-A Booster Use**
- 5-B Install Highback Booster**
- 5-C Install Backless Booster**
- 5-D Securing Child Highback Booster**
- 5-E Securing Child Backless Booster**

6 Accessories

Page 83

7 Additional Information

Pages 84-96

- 7-A How to Uninstall Lower Anchor Connectors and Tether**
- 7-B Choosing Vehicle Seat Location**
- 7-C Unsafe Vehicle Seat Location**
- 7-D Vehicle Seat Belts**
- 7-E Aircraft Installation**

8 Care & Cleaning

Pages 97-102

- 8-A Cleaning Seat Pad**
- 8-B Cleaning Buckle**
- 8-C Cleaning Harness, Lower Anchor Attachment and Tether**

1-A A Quick Guide to Your Manual

This car seat is for children: **Forward-Facing: 22-65 lb (10-30 kg)**
Highback Booster: 40-100 lb (18.1-45 kg)
Backless Booster: 40-120 lb (18.1-54 kg)



1 Important

Install Cup Holders (Adult Assembly Required)

Cup holders *MUST* be installed.

Place the tab on the cupholder into the corresponding slot on the base and rotate the cup up and into position as shown. **You will hear a “CLICK” when they are secured in place.**

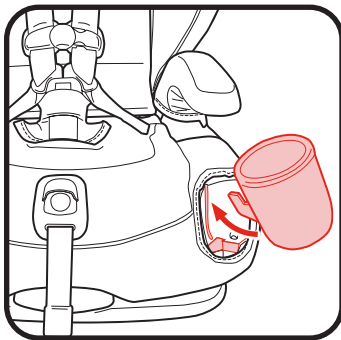

Get to Know Your Car Seat

Review section 2-A to see all of the features of this car seat.

What Seating Location Should I Use?

The best seating location for this car seat is one that:

- Is recommended by your vehicle owner's manual, and
- Results in a secure installation of this car seat.

Some vehicles have specific requirements for where the car seat can be installed, so be sure to check your vehicle owner's manual for available seating positions, if any. For example, sometimes the center rear seat has a lap belt only vehicle seat belt, which cannot be used when this car seat is in Booster mode.

Review section 7-B, 7-C and 7-D of this manual AND your vehicle owner's manual.



1 Important



1 Important

According to accident statistics, children are safer when properly restrained in the rear seating positions than in the front seating positions. The center of the back seat can be the safest during a possible side impact.



Which Installation Method Should I Use?

This car seat can be installed in your vehicle using either the vehicle seat belt **OR** the lower anchor attachment. Both are equally safe to use. **INSTALL USING ONLY ONE METHOD.** Graco allows the securing of the car seat with LATCH system in the booster mode, only if the vehicle manufacturer allows it. The child still **MUST BE SECURED** with the vehicle lap/shoulder seat belt.

Vehicle Seat Belt: Review section 7 and your vehicle owner's manual to learn how to install your car seat with the vehicle seat belts.

LATCH or Lower Anchor Attachment: The LATCH system or lower anchor attachment allows you to securely attach your safety seat in your car without using the vehicle seat belt and possibly to get a better fit. All 2003 and newer model year vehicles are required to have a LATCH system, although some manufacturers began including LATCH earlier. Some vehicle owner manuals use the term ISOFIX to identify the LATCH system.

What is LATCH?

LATCH consists of lower anchors and a tether anchor, which are built in to your vehicle, and a lower anchor attachment and a tether that are built in to your car seat. The lower anchor attachment is used **INSTEAD** of the vehicle's seat belt to secure the child seat to the vehicle. The tether is used **IN ADDITION** to the lower anchor attachment **OR** the vehicle's seat belt to secure a forward-facing car seat to the vehicle.

Review your vehicle owner's manual for exact location and use.

Vehicle's Tether Anchor

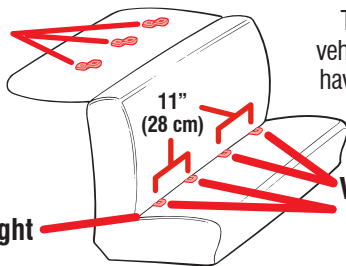

Typical seat in a passenger vehicle. Other vehicle types may have different lower anchor and tether anchor locations.

Vehicle Seat Belt

Vehicle's Lower Anchor



1 Important



1 Important

When Installing Forward-Facing

Lower Anchor Attachment

The lower anchor attachment consists of lower anchors, which are built in to your vehicle, and lower anchor connectors that are built in your car seat.

Review section 3-B of this manual AND your vehicle owner's manual before installing.

Lower anchor attachment can ONLY be used if the vehicle lower anchor spacing is 11 inches (28 cm) from the center of one lower anchor to the center of the other lower anchor.

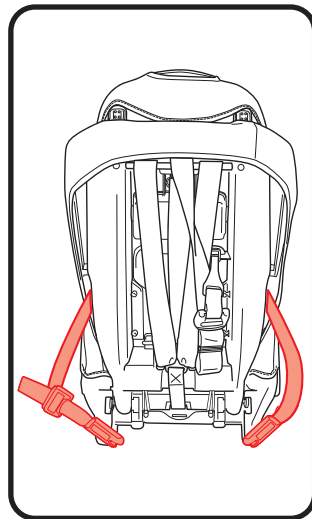
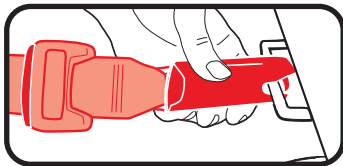

When Installing Forward-Facing (continued)

Vehicle Seat Belt

There are two types of vehicle seat belts that can be used. Lap/Shoulder Seat Belt or Lap Only Seat Belt.

Review section 3-C and 7 of this manual AND your vehicle owner's manual before installing.

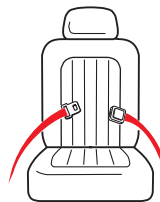
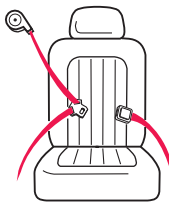

When Installing As a Booster

Vehicle Seat Belt

Only use the Lap/Shoulder seat belt configuration.

Review section 5-B, 5-C, 5-D, 5-E, and 7 of this manual AND your vehicle owner's manual.

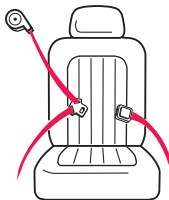

1 Important

Does Your Car Seat Fit Your Child Correctly?

To make sure your child is secured properly, review section 3, 4 and 5 to understand all of the actions you need to take to properly adjust the car seat to fit your child.

For Forward-Facing, You Need to Adjust:

Harness Height, Forward-Facing

Harness straps at or just above the child's shoulders **(A)** and top of child's ears below top of headrest **(B)**. Review section 4.

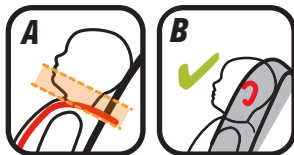

Buckle Position (C)

The correct slot is the one that is closest to your child without being underneath them. Review section 4.

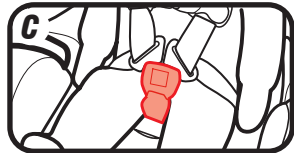

Harness Tightness (D)

If your fingers slide off the harness straps without pinching the straps, it is tight enough. Review section 4.

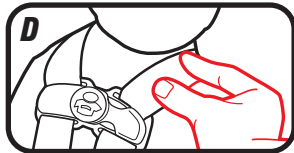

For Booster, You Need to Adjust:

Use Lap/Shoulder Belt Only

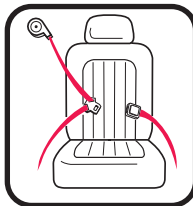

Position Lap Belt

Lap belt must go in front of armrest and lie low across your child's hips and thighs.

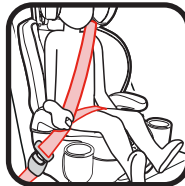

Position Shoulder Belt

Shoulder belt lies across shoulder between neck and edge of shoulder.

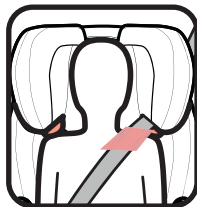

1 Important



1 Important

Forward-Facing Installation

Use the tether strap when using forward-facing (A)

When used properly, the tether helps reduce injury in a sudden stop or crash.

Review section 3

Car Seat Does Not Move More than 1" (2.5 cm) at the Belt Path (B)

Review section 3

Harness Straps at or Just Above Child's Shoulders (C)

Review section 4

Chest Clip Even With Armpits (D)

Review section 4

Cannot Pinch Harness Straps at the Shoulder (E)

Review section 4

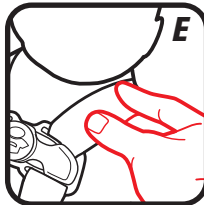
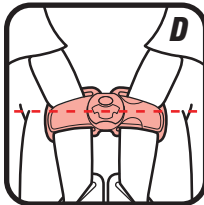
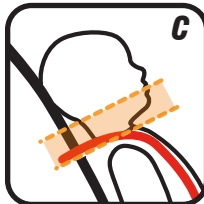
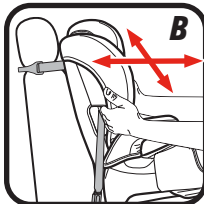
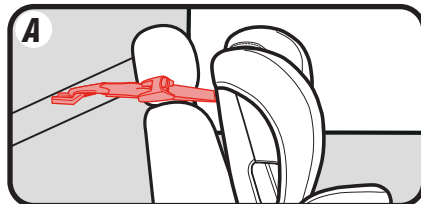

Booster Installation

Never Use Lap Belt Only

Review section 5



Lap Belt in Front of Armrest and Lies Low Across Hips and Thighs

Review section 5



Shoulder Belt Lies On the Shoulder, Between the Neck and Edge of Shoulders

Review section 5



1 Important

1-B Welcome to the Graco Family!

Your child's safety depends on you. No car seat can guarantee protection from injury in every situation, but proper use helps reduce the risk of serious injury or death.

Even if this car seat seems easy to figure out on your own, you must follow the detailed instructions in this instruction manual to ensure the steps below are performed correctly.



1 Important

1

1-C Right Mode of Use

22 lb (10 kg)	40 lb (18.1 kg)	65 lb (30 kg)	100 lb (45 kg)	120 lb (54 kg)
------------------	--------------------	------------------	-------------------	-------------------

Forward-Facing with 5-Point Harness

Must be 27-49" (69-125 cm) tall:

22-40 lb (10-18 kg) and can sit upright unassisted

MUST use 5-point harness. 40-65 lb (18-30 kg)

SHOULD use 5-point harness*.

Highback Booster Mode with Vehicle Lap/Shoulder Seat Belt

Must be 43-57" (110.1-145 cm) tall and 4+ years old:

40-65 lb (18.1-30 kg) **CAN** be in booster mode.

Over 65 lb (30 kg) **MUST** be in booster mode.*

Backless Booster Mode with Vehicle Lap/Shoulder Seat Belt

Must be 43-57" (110.1-145 cm) tall and 4+ years old:

40-65 lb (18.1-30 kg) **CAN** be in booster mode.

Over 100 lb (45 kg) **MUST** be in backless booster mode.*

*Check your state laws and the AAP/NHTSA recommendations. Review page 22 more for information.



1 Important

1-D Before You Begin

Register This Child Restraint



1 Important

1

Please fill out the prepaid registration postcard attached to the harness and mail it in today **or register online at www.gracobaby.com/carseatregistration**.

Child restraints could be recalled for safety reasons. You must register this restraint to be reached in a recall. Send your name, address, and the restraint's model number and manufacturing date to:

Graco Children's Products, Inc.

Attn: Customer Service

P.O. Box 169, Elverson, PA 19520-9901

or call 1-800-345-4109

or register online at www.gracobaby.com/carseatregistration

For recall information, call the U.S. Government's Vehicle Safety Hotline at 1-888-327-4236 (TTY: 1-800-424-9153), or go to <http://www.NHTSA.gov>

For future reference or if you change addresses, record the model name, model number, date of manufacture and purchase date of this car seat on the below. You can find this information either on the registration card if you still have it or on the date label located on the bottom of the car seat.

Model Name _____

Model Number _____

Date of Manufacture _____

Date of Purchase _____

If You Need Help

In the U.S.A, please contact our Customer Service Department with any questions you may have concerning parts, use, or maintenance. When you contact us, please have your product's model number and date of manufacture ready so that we may help you efficiently. These numbers can be found on a sticker on the bottom of your car seat.

For additional resources or to get your car seat checked by a child passenger safety technician, please visit the following web sites:

www.nhtsa.gov • www.seatcheck.org • www.safekids.org



1 Important



Important

1

Certification

This child restraint meets or exceeds all applicable requirements of Federal motor vehicle safety standard 213 for use in motor vehicles.



This car seat is certified for use in aircraft when using the harness system and without using the lock-off. Use only on forward-facing aircraft seats. Follow the instructions for vehicle installation and section 7-E for routing the aircraft lap belt over the lock-off. See section 3-C for installation but do not use the tether. See section 7-D “ Vehicle Seat Belts” and section 7-E “Aircraft Installation”.



This car seat is NOT certified for use in aircraft when using the lockoff OR when used as a booster seat because aircrafts do not have shoulder belts.

Contact the airline for their specific polices.

Car Seat's Useful Life

STOP using this car seat and throw it away 10 years after the date of manufacture. Look for date of manufacture label on bottom of the car seat.

Graco Children's Products Inc. advises against loaning or passing along a car seat unless you know the complete history of the product. We also advise against purchasing a car seat second hand.

Vehicle Seat Protection

Protect vehicle seat. Use a car seat mat, towel, or thin blanket under and behind car seat.

Warm Weather Use

Car seat parts can get very hot in the sun or warm weather. **To avoid burns, always check before putting child in car seat.**

1-E Safety Warnings

No car seat can guarantee protection from injury in every situation, but proper use helps reduce the risk of serious injury or death. **READ THIS MANUAL CAREFULLY.**

! WARNING!

Failure to follow these instructions and child restraint's labels can result in child striking the vehicle's interior during a sudden stop or crash.



1 Important



1 Important

- ! Review your vehicle owner’s manual for more information about air bags and car seat use.**
- ! If your vehicle does not have a back seat, review your vehicle owner’s manual.**
- ! Select a suitable location for the car seat in your vehicle.**
- ! When forward-facing, children should use the built-in harness system for as long as possible until they reach the maximum forward-facing weight or height for their car seat. At that point, children should ride in a belt-positioning booster seat. A booster is no longer needed once the vehicle seat belt fits properly, typically when they reach 4 feet 9 inches tall and are between ages 8-12. Be sure to check your local and state laws, as well as AAP and NHTSA recommendations, for car seat usage.***
- ! Secure car seat with a vehicle seat belt or LATCH that is properly routed as shown in this manual.**
- ! Vehicle seat belt system MUST hold car seat securely. Not all vehicle seat belts can be used with a car seat.**
- ! If vehicle seat belt does not hold car seat securely, read “Vehicle Seat Belts” section 7-D and your vehicle owner’s manual.**

*Graco Supports the American Academy of Pediatrics and National Highway Traffic Safety Administration’s Car Seat Guidelines. Visit www.gracobaby.com/en-US/safety for information on car seat usage recommendations.



1 Important

- ! Always secure car seat with lower anchor attachment or a vehicle seat belt, even when unoccupied. In a crash, an unsecured car seat can injure passengers.**
- ! If car seat is in a crash, it must be replaced. DO NOT use it again! A crash can cause unseen damage and using it again could result in serious injury or death.**
- ! DO NOT use car seat if it is damaged or missing parts.**
- ! DO NOT use accessories or parts other than those provided by Graco except for a thin towel or mat to protect your vehicle seat. Their use could alter the performance of the car seat.**
- ! DO NOT remove LATCH system from car seat. If using vehicle seat belt to secure car seat, lower anchor connectors must be stored.**
- ! Never leave child unattended, even when sleeping. Child may become tangled in harness straps and suffocate or strangle.**



- ! Never attach two lower anchor connectors to one vehicle lower anchor point unless specifically allowed by the vehicle manufacturer.**
- ! Do not use both the vehicle seat belt and lower anchor attachment at the same time when using the car seat forward-facing with the 5-point harness.**

2-A Car Seat Features

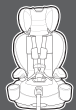

2 Features

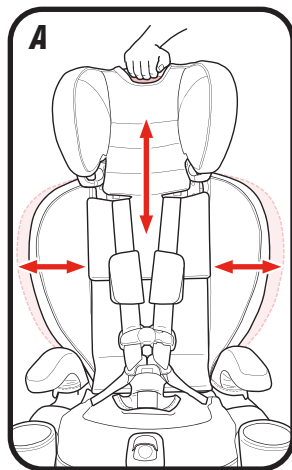
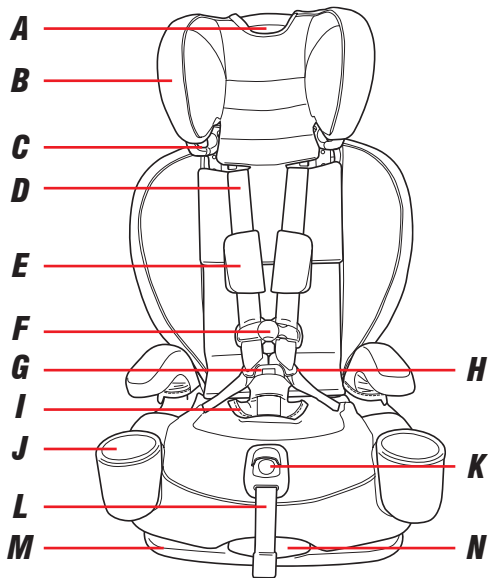

A Headrest/Harness Height Adjustment Lever

(With Grow Technology, the backrest will move outward as the headrest moves up)

B Headrest

C Booster Shoulder Belt Guide

D Harness Straps

E Harness Covers

F Chest Clip

G Buckle

H Buckle Tongues

I Buckle Cover

J Cup Holder

K Harness Adjustment Lever

L Harness Adjustment Strap

M Recline Foot

N Recline Handle

O Harness Storage Compartment

(under lower backrest pad)

P SnugLock® Lock-Off

(under lower backrest pad)

Q Lower Anchor Attachment

(under lower backrest pad)

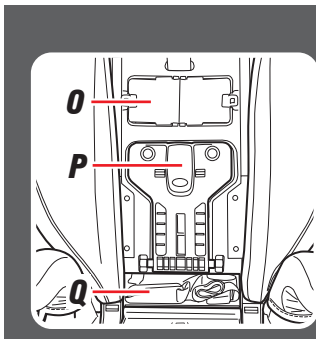

Lower Anchor Attachment
(under lower backrest pad)

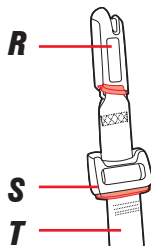

- R Lower Anchor Connector**
- S Lower Anchor Strap Adjuster**
- T Lower Anchor Strap**



2 Features

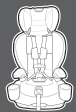

2 Features

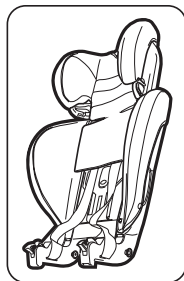
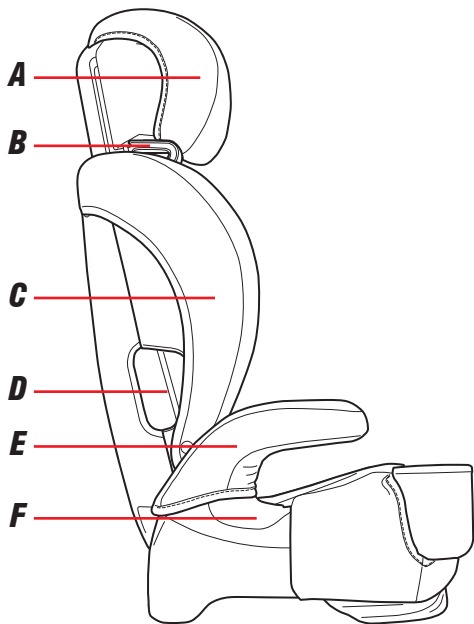

Back Support

- A Headrest**
- B Shoulder Belt Guide**
- C Side Panel**
- D Forward-Facing Belt Path**
- E Armrest**
- F Booster Belt Guide**



2 Features

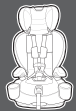

2 Features

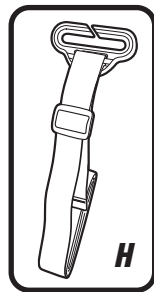
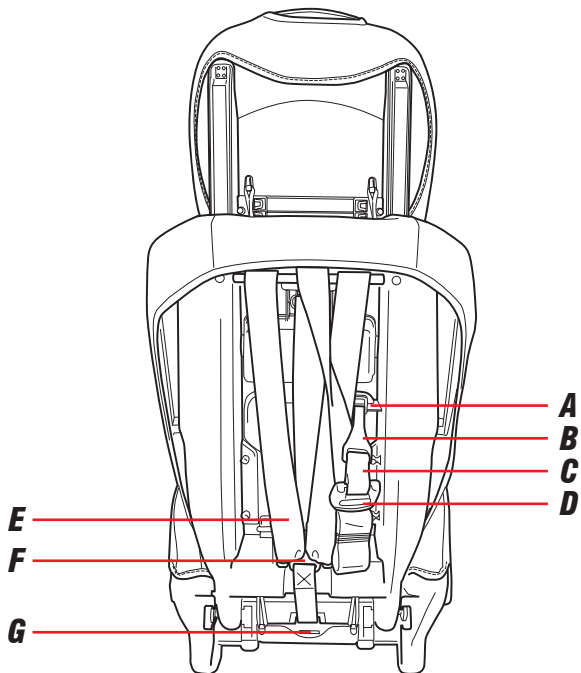

- A** *Tether Storage Bar*
- B** *Tether Hook*
- C** *Tether Strap*
- D** *Tether Strap Adjuster*
- E** *Harness Straps*
- F** *Splitter Plate*
- G** *Belt Positioning Clip Attachment Point*
- H** *Belt Positioning Clip*



2 Features



3-A Forward-Facing

3-A Forward-Facing Use

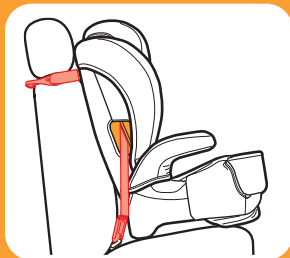

LATCH

Do not install by this method for a child weighing more than 45 lb (20 kg)

***Forward-Facing Harness Mode:
22-65 lb (10-30 kg) and 27-49"
(69-125 cm) at least one year old***



- For children over 40 lb (18.1 kg) you **MUST** use the most upright recline position.
- Place car seat forward-facing in the vehicle back seat.
- Make sure lower anchor strap or vehicle seat belt is routed through the forward-facing belt path marked with an orange label.
- Attach and tighten tether strap. When used properly, the tether helps reduce injury in a sudden stop or crash.
- Install this car seat tightly in your vehicle. Car seat **should not move** at the forward-facing belt path more than 1" (2.5 cm) from side to side, front to back.
- Harness straps need to be **even with or just above** the top of child's shoulders and chest clip is at **armpit level**.

- When forward-facing, children should use the built-in harness system for as long as possible until they reach the maximum forward-facing weight or height for their car seat. At that point, children should ride in a belt-positioning booster seat. A booster is no longer needed once the vehicle seat belt fits properly, typically when they reach 4 feet 9 inches tall and are between ages 8-12. Be sure to check your local and state laws, as well as AAP and NHTSA recommendations, for car seat usage.

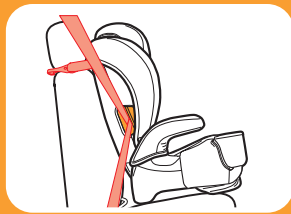

Vehicle Seat Lap/Shoulder Belt with Tether

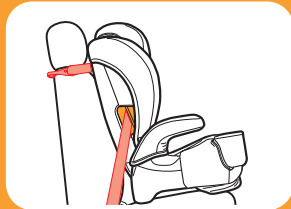

Vehicle Seat Lap Belt with Tether

Visit www.gracobaby.com and the Graco® Nautilus® SnugLock® Grow™ 3-in-1 Harness Booster Car Seat product page to view installation videos.



3-A Forward-Facing

3-B Install Forward-Facing with LATCH

Review your vehicle owner's manual for LATCH location and use. Do not install by this method for a child weighing more than 45 lb (20 kg).

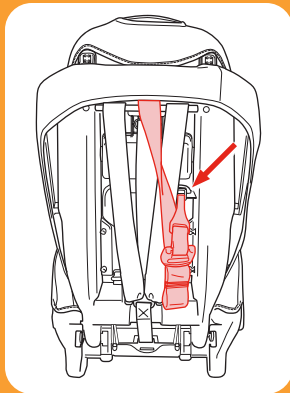

Visit www.gracobaby.com and the Graco® Nautilus® SnugLock® Grow™ 3-in-1 Harness Booster Car Seat product page to view installation videos.

- 1. Remove Tether Strap from Storage Location**
Unhook tether and lay it on the seat.

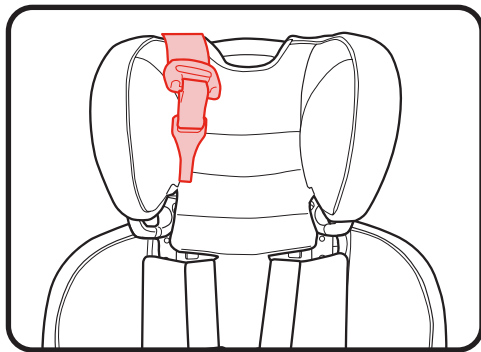

2. Expose the SnugLock® Lock-Off

- A.** Loosen the harness straps.
- B.** Raise the headrest to the highest position.
- C.** Unbuckle the chest clip.
- D.** Unbuckle the buckle.
- E.** Lift the headrest pad flap up and out of the way.

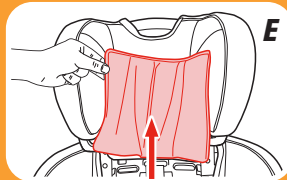
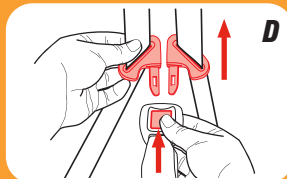
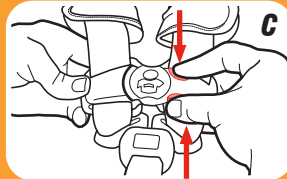
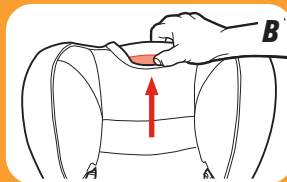
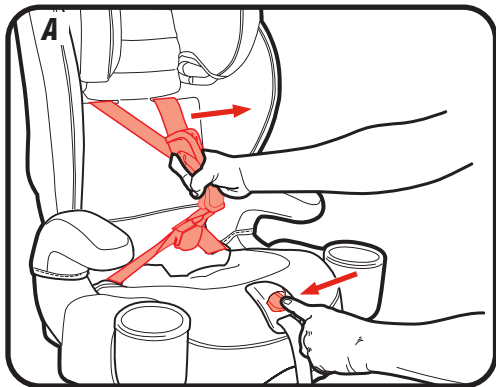

3-B

with LATCH

Forward-Facing

3-B Forward-Facing
with LATCH

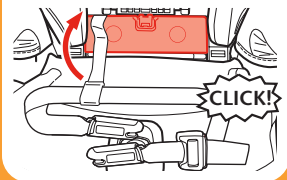
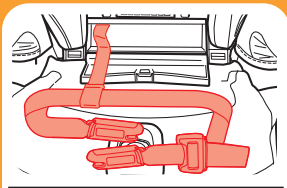
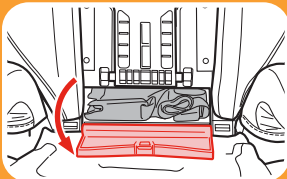
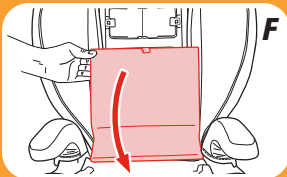

F Pull down lower backrest pad.

3. Open Lower Anchor Attachment Storage Door

4. Take the Lower Anchor Attachment Out of the Storage Compartment

Close the door.

5. Thread the Lower Anchor Attachment Through the Forward-Facing Belt Path

Push the lower anchor with the adjuster into the forward-facing belt path on the child's left as shown. Push the other lower anchor in the belt path on the child's right. Make sure the lower anchor strap is routed behind the harness straps.

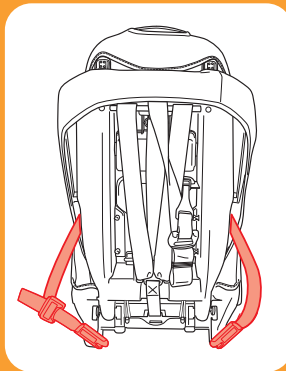
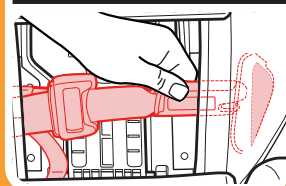
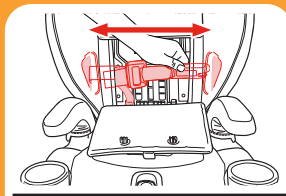
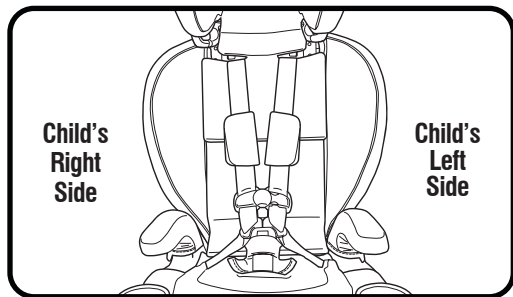

3-B Forward-Facing
with LATCH

3-B Forward-Facing
with LATCH

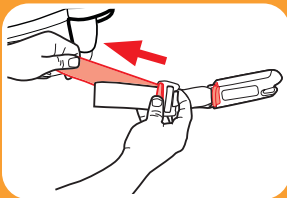
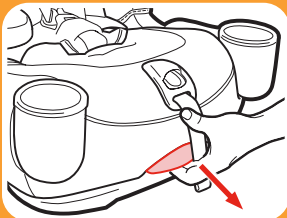

6. Place Car Seat Forward-Facing in Back Seat of the Vehicle

Place forward-facing in vehicle seat. The bottom of the seat should sit as flat as possible on the vehicle seat.

Note: Make Sure Base is a minimum of 80% on Vehicle Seat.

7. Choose One of the Four Recline Positions

To recline, pull recline handle out and tilt the seat back. For upright position, pull recline handle out and push down on front of seat.

For children over 40 lb (18.1 kg) you MUST use the most upright recline position.



8. Extend the Lower Anchor Strap

For easier installation, extend the lower anchor strap to its maximum length by pressing the button and pull out on the strap.

9. Open the SnugLock® Lock-Off

Move the lower anchor strap above the SnugLock® Lock-Off. Push the bottom of the release tab, then pull the top of the tab out. Open the SnugLock® Lock-Off.

10. Route the Lower Anchor Strap

Place the lower anchor strap into the SnugLock® Lock-Off.

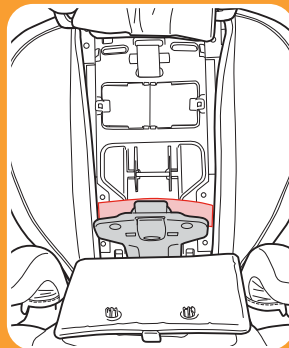
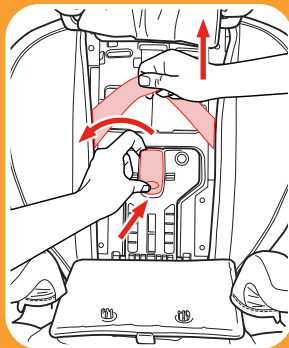

3-B
Forward-Facing
with LATCH

Forward-Facing 3-B with LATCH

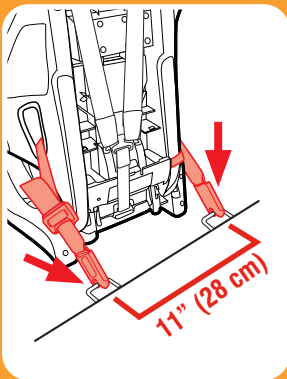
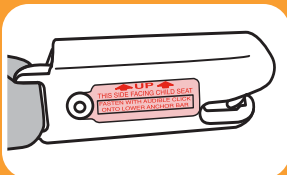

11. Attach Lower Anchor Connectors to Vehicle's Lower Anchors

Make sure that the red button faces away from the car seat and the arrows are pointing up. The lower anchor strap should not be twisted.

Lower anchor connectors can only be used if the vehicle lower anchor spacing is 11 inches (28 cm) from the center of one lower anchor to the center of the other lower anchor.

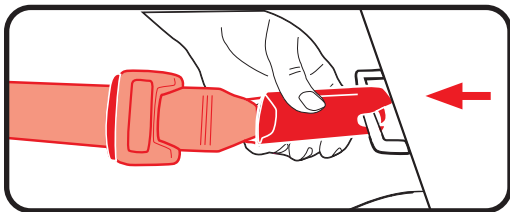

12. Tighten the Lower Anchor Strap

Press down firmly in the center of the car seat while tightening the lower anchor strap. You may need to tighten through the slit in the pad at the belt path as shown. Do not pull on the strap with excessive force.

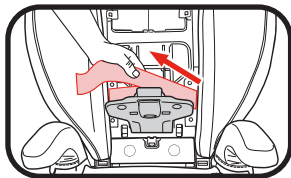

13. Close the SnugLock® Lock-Off

When the slack is removed, close the SnugLock® Lock-Off until you hear a “CLICK”. Make sure the lower anchor strap is under the SnugLock® Lock-Off.

⚠ WARNING!

Keep hands away from the lock-off area when closing the lock-off.

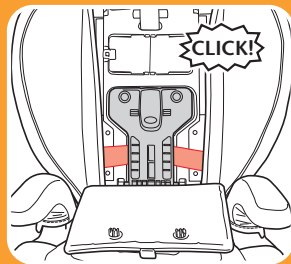
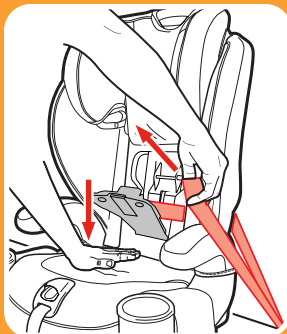

3-B Forward-Facing
with LATCH

Forward-Facing
3-B with LATCH

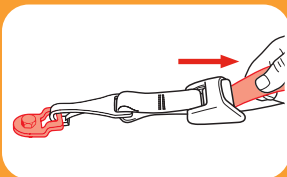
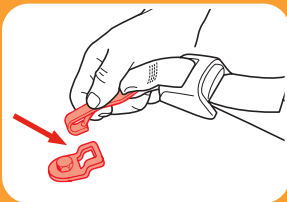
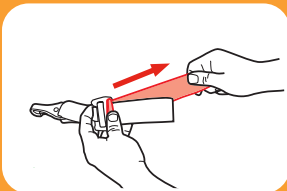

14. **Attach Tether Strap**

Extend the tether by pressing the grey button and pulling out on the strap and attach.

Consult vehicle owner's manual for specific location.

15. **Tighten Tether Strap**

Remove all the slack.

16. Test For Tightness

Grab the sides of the seat where the lower anchor strap is and slide the car seat side-to-side and front-to-back.

If the seat moves less than 1" (2.5 cm), it is tight enough.

See section 4-A to secure your child.

17. Replace the Seat Pad

Move the headrest back to its proper position for your child.

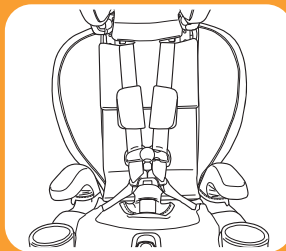
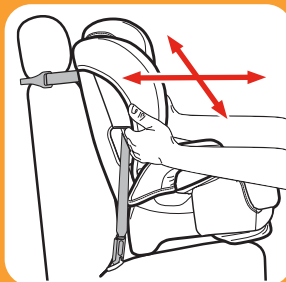

3-B
Forward-Facing
with LATCH



3-B Forward-Facing with LATCH

Is Everything Correct?

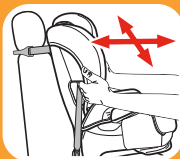

Car Seat Does Not Move More than 1" (2.5 cm) at the Belt Path



Harness Straps at or Just Above the Child's Shoulders

Review section 4

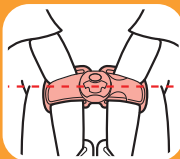

Chest Clip Even With Armpits

Review section 4



Cannot Pinch Harness Straps at the Shoulder

Review section 4

3-C Install Forward-Facing with Vehicle Seat Belt

1. Store Lower Anchor Attachment in Storage Compartment

Open storage compartment and store lower anchor connectors. Close the storage compartment door.

2. Remove Tether Strap from Storage Location

Unhook tether and lay it on the seat.

Visit www.gracobaby.com and the Graco® Nautilus® SnugLock® Grow™ 3-in-1 Harness Booster Car Seat product page to view installation videos.

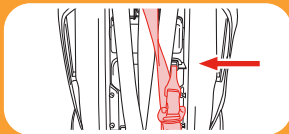
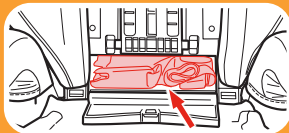

3-C Forward-Facing
with Seat Belt

3-C Forward-Facing with Seat Belt

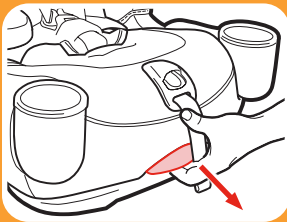

3. Place Car Seat Forward-Facing in Back Seat of the Vehicle

Place forward-facing in vehicle seat. The bottom of the seat should sit as flat as possible on the vehicle seat.

Note: Make Sure Base is a minimum of 80% on Vehicle Seat.

4. Choose One of the Four Recline Positions

To recline, pull recline handle out and tilt the seat back. For upright position, pull recline handle out and push down on front of seat.

For children over 40 lb (18.1 kg) you MUST use the most upright recline position.

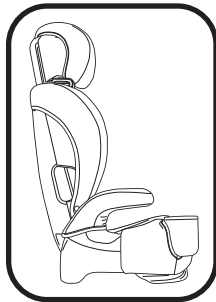

5. Expose the SnugLock® Lock-Off

- A.** Loosen the harness straps.
- B.** Raise the headrest to the highest position.
- C.** Unbuckle the chest clip.
- D.** Unbuckle the buckle.
- E.** Lift the headrest pad flap up and out of the way.

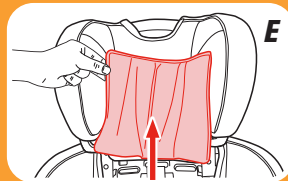
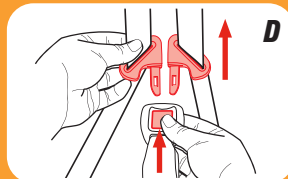
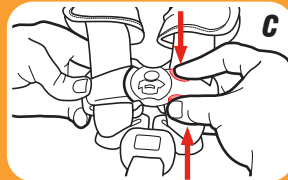
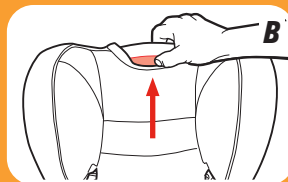
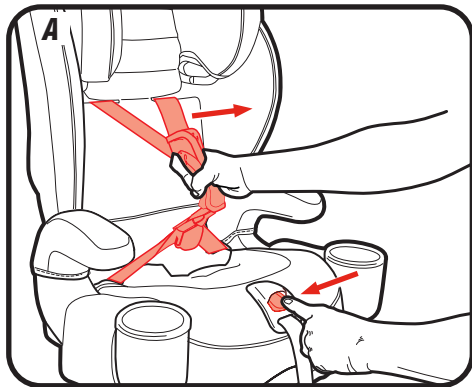

3-C Forward-Facing
with Seat Belt

3-C Forward-Facing with Seat Belt

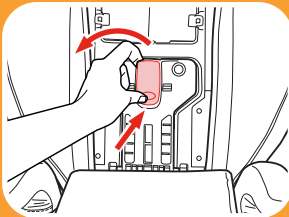
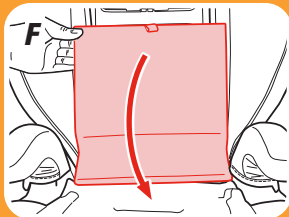

F Pull down the lower backrest pad to expose the SnugLock® Lock-Off.

6. Open the SnugLock® Lock-Off

Push the bottom of the release, then pull the top of the tab out. Open the SnugLock® Lock-Off.

Review your vehicle owner's manual for vehicle seat belt use

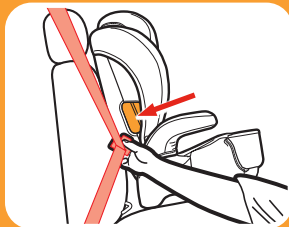

7. Route the Vehicle Seat Belt

Thread vehicle seat belt through the forward-facing belt path (marked with an orange label), through the SnugLock® Lock-Off, and out the other side. Buckle the seat belt. The seat belt should lie as flat as possible and not be twisted.

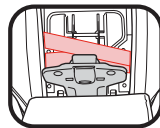

8. Tighten the Vehicle Seat Belt

Press down firmly in the center of the car seat. Pull on the shoulder belt to tighten while feeding the slack back in the retractor. Do not pull on the strap with excessive force.

9. Close the SnugLock® Lock-Off

When the slack is removed, close the SnugLock® Lock-Off until you hear a “Click”. Make sure the vehicle seat belt is under the SnugLock® Lock-Off.

Note: When using the lock-off, you are not required to switch the retractor as an installation step. The lock-off locks the seat belt. However, it is recommended to switch the retractor after the installation is complete to avoid a possible strangulation risk.

⚠ WARNING!

Keep hands away from the lock-off area when closing the lock-off.

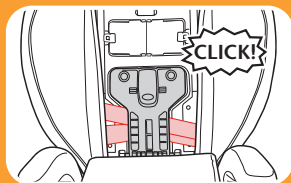
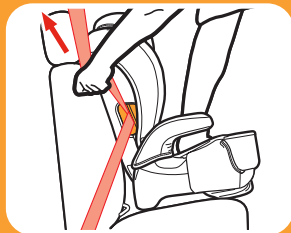

3-C Forward-Facing
with Seat Belt

3-C Forward-Facing with Seat Belt

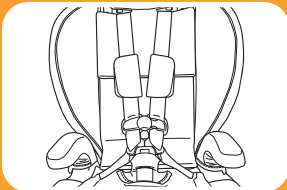
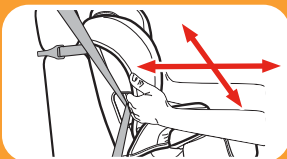
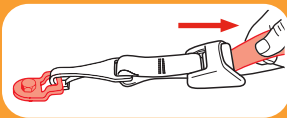
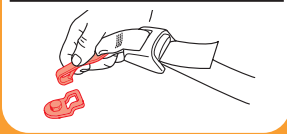
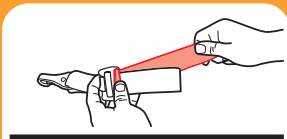

10. Attach Tether Strap

Extend the tether by pressing the grey button and pulling out on the strap and attach.

Consult vehicle owner's manual for specific location.

11. Tighten Tether Strap

Remove all the slack.

12. Test For Tightness

Grab the sides of the seat where the seat belt is and slide the car seat side-to-side and front-to-back.

If the seat moves less than 1" (2.5 cm), it is tight enough.

See section 4-A to secure your child.

13. Replace the Seat Pad

Move the headrest back to its proper position for your child.

Is Everything Correct?

Car Seat Does Not Move More than 1" (2.5 cm) at the Belt Path

Harness Straps at or Just Above the Child's Shoulders

Review section 4

Chest Clip Even With Armpits

Review section 4

Cannot Pinch Harness Straps at the Shoulder

Review section 4

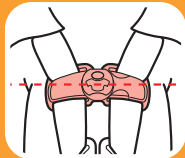
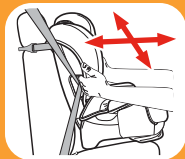

3-C Forward-Facing
with Seat Belt



4 Securing Child 5-Point Harness

! WARNING!

WARNING! In cold weather, do not put snowsuits or bulky garments on your child when placing them in the car seat. Bulky clothing can prevent the harness straps from being tightened properly. To keep child warm, buckle your child in the car seat and place a blanket around the child or place the child's coat on backwards after buckling in.



4-A Securing Child 5-Point Harness

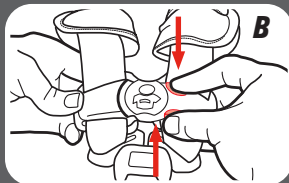
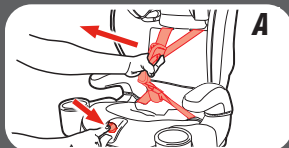

1. Loosen Harness Straps

(A) Push down on the harness release lever while pulling out on the harness straps at the chest clip.

(B) Unbuckle the chest clip and the buckle strap.

(C) Place harness straps off to the sides.

2. Place Your Child in the Seat

Make sure their back is flat against the car seat back.

3. Place Harness Straps Over Child's Shoulders and Buckle

You will hear a “click” when buckle tongues are securely attached. Pull up on each buckle tongue to make sure it is securely attached.

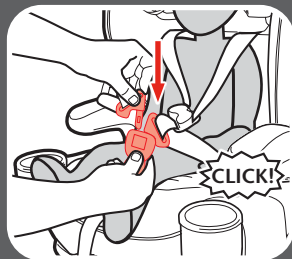
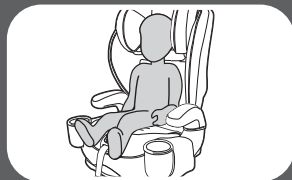
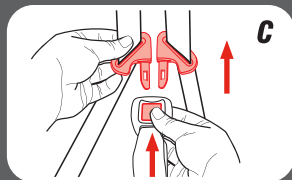

4 Securing Child 5-Point Harness

4 Securing Child 5-Point Harness

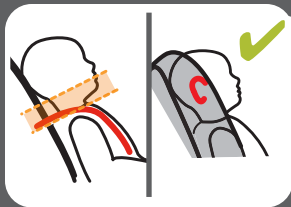

Forward-Facing

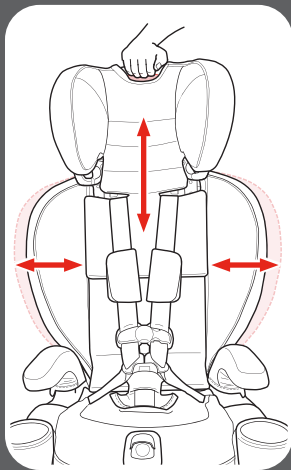

4. Be Sure the Harness Straps Are at the Proper Height

Forward-Facing: Harness straps must be **at or just above** the child's shoulders and top of child's ears must be **below** top of headrest.

5. To Raise or Lower Headrest/Harness

Squeeze the adjustment lever and lift or lower headrest for the proper harness height.

Note: With Grow Technology, the backrest will automatically move outward as the headrest moves up to allow for more room for your child.

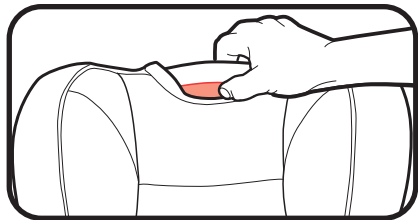



4 Securing Child 5-Point Harness

6. Check the Buckle Position

The correct slot the one that is closest to your child without being underneath your child.

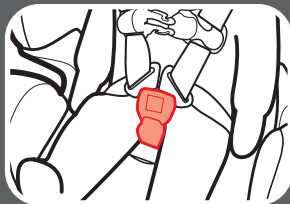

7. To Adjust the Buckle Strap

From bottom of car seat, rotate metal retainer to side in order to push it through slot easier.

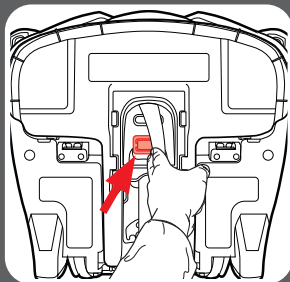

8. Pull buckle strap from child restraint as shown.

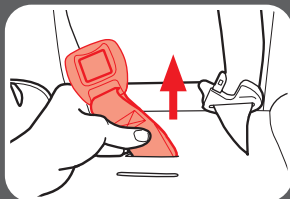

4 Securing Child 5-Point Harness

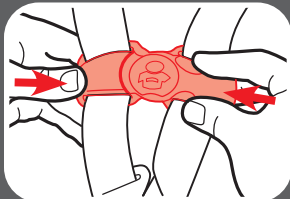
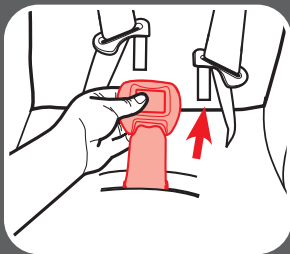
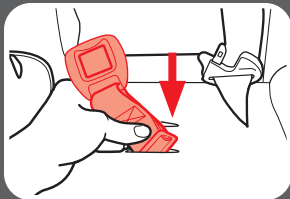

9. Insert Metal Retainer in the New Buckle Strap Slot

Reach underneath the car seat and pull the metal retainer through.

10. Pull Up on Buckle Strap to Make Sure it is Secured

11. Buckle the Chest Clip

You will hear a “click” when the chest clip is securely buckled.

12. Pull All the Slack Out From Around the Waist

Pull up on the harness strap while pushing the chest clip down. Do this to both sides.

13. Tighten the Harness by Pulling the Harness Adjustment Strap

When you are not able to pinch any of the harness webbing at your child's shoulder, the harness is tight enough.

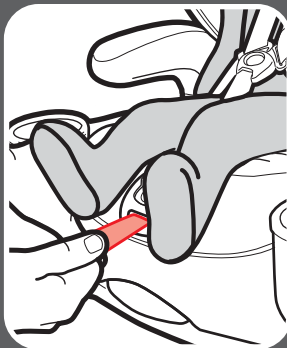
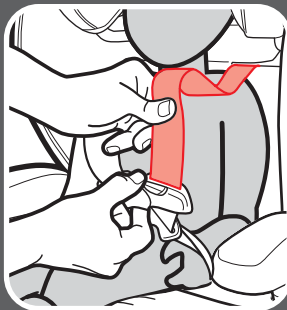

4 Securing Child 5-Point Harness

4 Securing Child 5-Point Harness

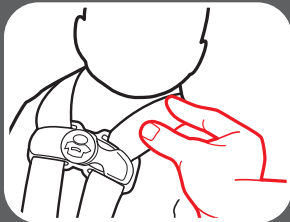
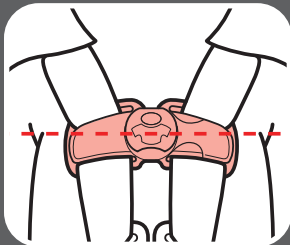
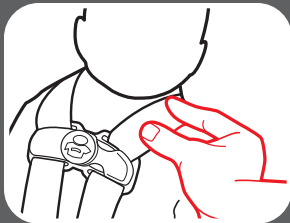

A snug harness should not allow any slack. It lies in a relatively straight line without sagging. It does not press on the child's flesh or push the child's body into an unnatural position.

14. Raise the Chest Clip to Child's Armpit Level

15. Check Tightness Again, Tighten More if Needed

5-A Booster Use

Highback Booster:
40-100 lb (18.1-45 kg)
43-57" (110.1-145 cm)
at least 4 years old



Backless Booster:
40-120 lb (18.1-54 kg)
43-57" (110.1-145 cm)
at least 4 years old

- Place car seat forward-facing in the vehicle back seat.
- Make sure vehicle seat's lap belt is adjusted snugly and lays low on the child's hip and is routed in front of the armrest in the booster's belt path.
- Vehicle belts **MUST** lie flat against child and **MUST NOT** be twisted.
- Vehicle seat's shoulder belt is adjusted snugly and should lie between child's neck and edge of shoulder.
- Booster seat **MUST** be in the most upright position.

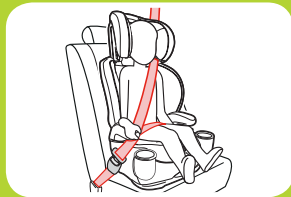

**Vehicle Lap/Shoulder
Seat Belt**



**Vehicle Lap/Shoulder
Seat Belt**



5-A
Booster



5-A Booster



Never Use a Vehicle Lap-Only Belt Across Front of Child

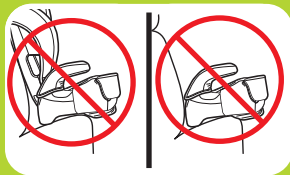

- **Never** use a vehicle lap-only belt across front of child.
- **DO NOT** position vehicle shoulder belt under the child's arm or back.
- **DO NOT** allow child to slouch or slide down in the booster seat.
- **DO NOT** position vehicle belt over top of armrests.
- Vehicle's seat headrest **SHOULD NOT** create a gap between vehicle seat and booster seat.
- The front of booster seat **MUST NOT** hang over front of vehicle seat.
- If child will not keep vehicle belt properly positioned, **DO NOT** use this booster seat. Use a different car seat.
- When forward-facing, children should use the built-in harness system for as long as possible until they reach the maximum forward-facing weight or height for their car seat. At that point, children should ride in a belt-positioning booster seat. A booster is no longer needed once the vehicle seat belt fits properly, typically when they reach 4 feet 9 inches (145 cm) tall and are between ages 8-12. Be sure to check your local and state laws, as well as AAP and NHTSA recommendations, for car seat usage.

5-B Install Highback Booster

1. Store The Harness System

A. Raise the headrest to the highest position



B. Loosen Harness Straps

Push down on the harness release lever while pulling out on the harness straps.

C. Unbuckle the chest clip

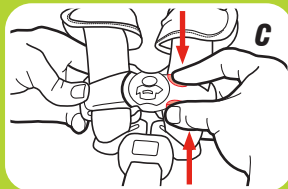
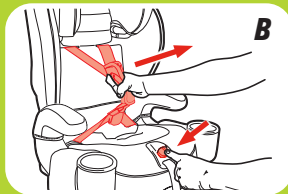
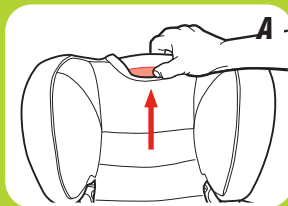

5-B
Highback
Booster

5-B Highback Booster

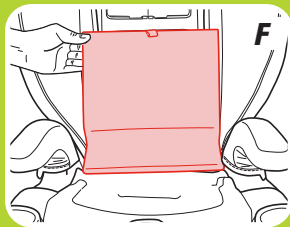
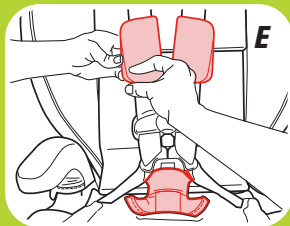
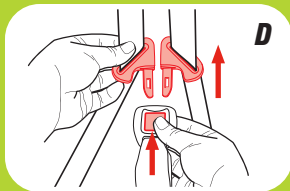

D. Unbuckle the buckle

E. Remove Harness Covers and Buckle Cover

Store for future use.

F. Remove Lower Backrest Pad

To remove lower backrest pad, pull the top of the pad off the seat, undo both snaps and remove.

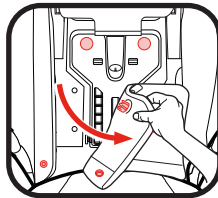

G. Unsnap the Seat Base Pad

From the sides of the seat, pull down on the tabs at the corners of the seat pad to remove from the keyholes.

Unhook the elastic loops on the back of the seat. Unsnap both sides of the seat base pad.

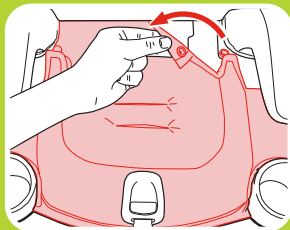
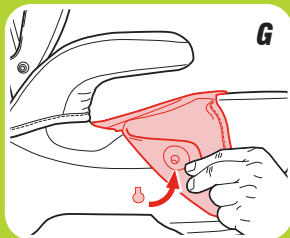
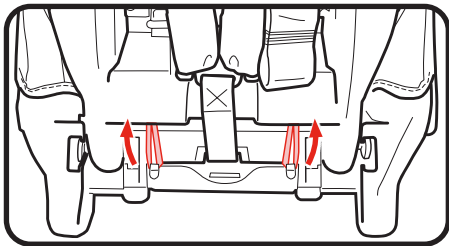

H. Store the Buckle

Lift base pad up and pull the buckle through the pad and store the buckle as shown.

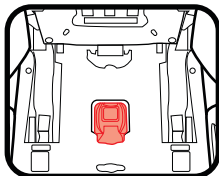

**5-B Highback
Booster**



5-B Highback Booster

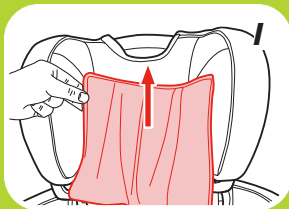

I. Pull Up Headrest Pad to Expose the Harness Storage Location

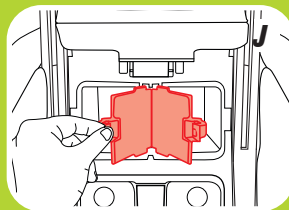

J. Open Harness Storage Doors

**K. Place Harness, Chest Clip and Buckle
Tongues Inside Storage Compartment and
Close the Door**

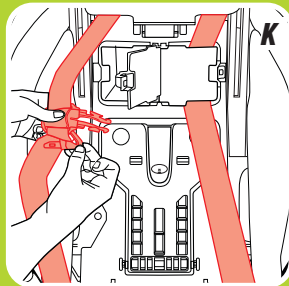

L. Replace the Seat Pads

Replace the headrest pad and lower backrest pad. Resnap the seat base pad. Reattach the key holes on the sides of the seat. Reattach the 2 elastic loops to the back of the seat.

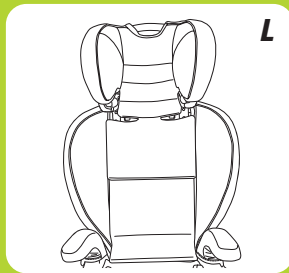
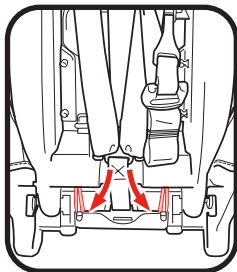
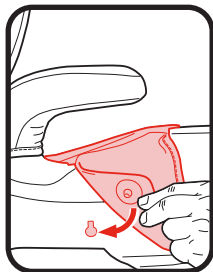

**5-B
Highback
Booster**



5-B Highback Booster

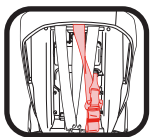
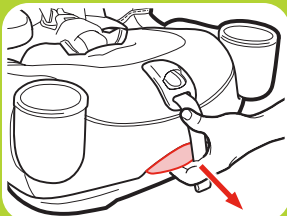

2. Place Booster Seat in the Most Upright Position

Pull the recline handle out and push down on front of seat. Put the booster seat in the most upright position.

3. Place Car Seat Forward-Facing in Back Seat of the Vehicle

Place forward-facing on a vehicle seat that has a lap/shoulder seat belt. The bottom of the seat should sit as flat as possible on the vehicle seat.

Graco allows the securing of the car seat with LATCH in the booster mode, only if the vehicle manufacturer allows it. The child still **MUST BE SECURED** with the vehicle lap/shoulder seat belt. LATCH can be used in the booster mode regardless of the weight of the child up to 100 lb (45 kg).

Verify the following before using LATCH in the booster mode:

- The lower anchor connectors **DO NOT** interfere with any vehicle seat belts or buckles.

If the lower anchor connectors interferes with the vehicle seat belts or if the chosen seating position does not have lower anchor connectors, you **MUST** store the lower anchor strap. Store lower anchor attachment by placing lower anchor strap and connectors in storage compartment. Store the tether strap as shown. Always secure car seat with lower anchor attachment or a vehicle seat belt, even when unoccupied. In a crash, an unsecured car seat can injure passengers.

Skip to Step 18 if Not Using LATCH

4. Remove Tether Strap from Storage Location

Unhook tether and lay it on the seat.

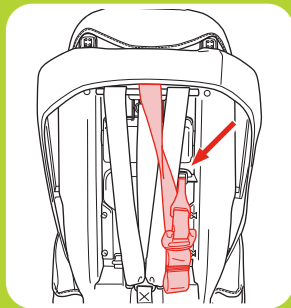
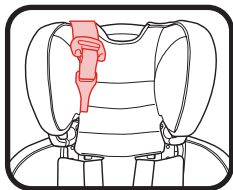

5. Move the Seat Pads

Lift the headrest pad up and out of the way. Remove the lower backrest pad.

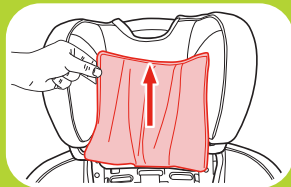
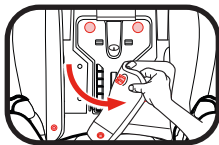

6. Open the Lower Anchor Attachment Storage Door

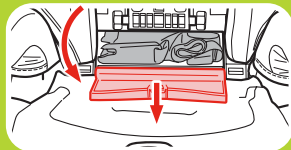

**5-B Highback
Booster**



5-B Highback Booster

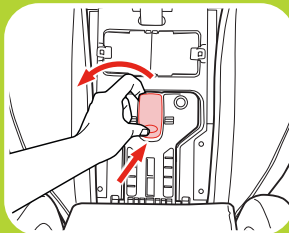
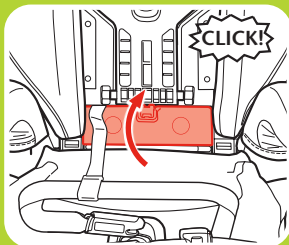
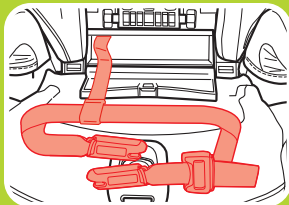

7. Take the Lower Anchor Attachment Out of the Storage Compartment

8. Close the Lower Anchor Attachment Storage Door

9. Open the SnugLock® Lock-Off

Push the bottom of the release, then pull the top of the tab out. Open the SnugLock® Lock-Off.

10. Thread the Lower Anchor Attachment Through the Forward-Facing Belt Path

Push the lower anchor with the adjuster into the forward-facing belt path on the child's left as shown. Push the other lower anchor in the belt path on the child's right. Make sure the lower anchor strap is routed behind the harness straps and behind the SnugLock® lock-off.

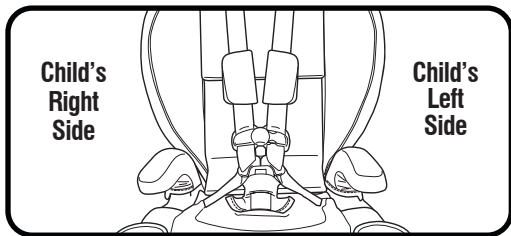
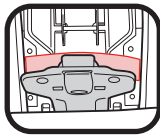

11. Extend the Lower Anchor Strap

For easier installation, extend the lower anchor strap to its maximum length by pressing the grey button and pull out on the strap.

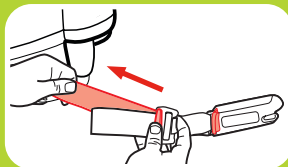
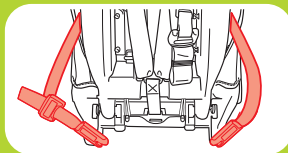
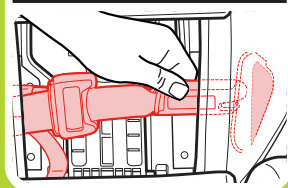
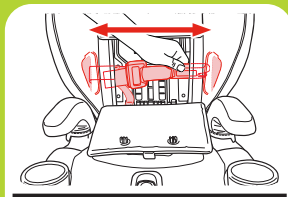

5-B Highback
Booster



5-B Highback Booster

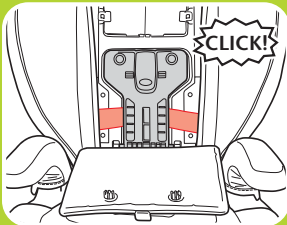
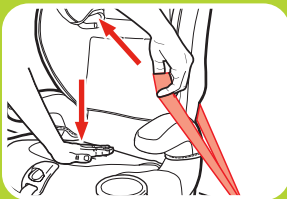
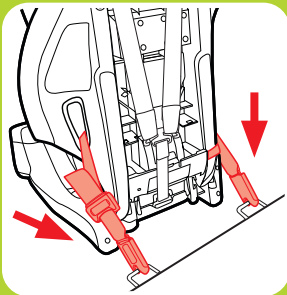

12. Attach Lower Anchor Connectors to Vehicle's Lower Anchors

Make sure that the red button faces away from the car seat and the arrows are pointing up. The lower anchor strap should not be twisted.

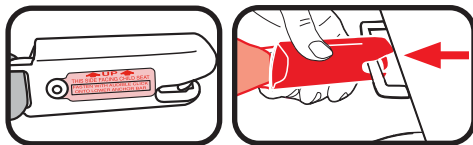

13. Tighten the Lower Anchor Strap

Remove all the slack from the lower anchor strap. Do not pull on the strap with excessive force.

14. Close the SnugLock® Lock-Off

When the slack is removed, close the SnugLock® Lock-Off until you hear a “Click”. Make sure the lower anchor strap is under the SnugLock® Lock-Off.

⚠ WARNING!

Keep hands away from the lock-off area when closing the lock-off.

15. Attach Tether Strap

Extend the tether by pressing the grey button and pulling out on the strap and attach.

Consult vehicle owner's manual for specific location.

16. Tighten Tether Strap

Remove all the slack.

17. Replace the Seat Pads

Move the headrest back to its proper position for your child.

18. Thread the Vehicle Seat Shoulder Belt Through Seat Belt Guide on the Headrest

See section 5-D to secure your child.

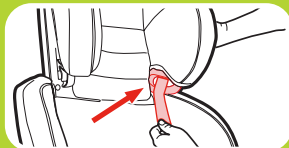
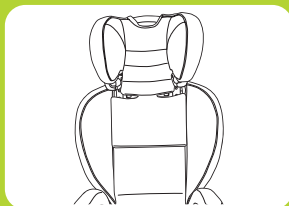
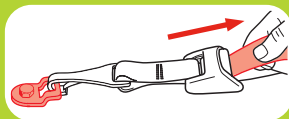
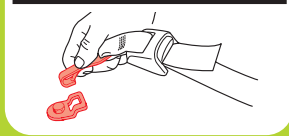
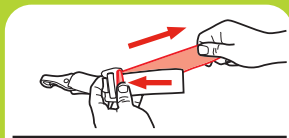

**5-B Highback
Booster**



5-C Install Backless Booster

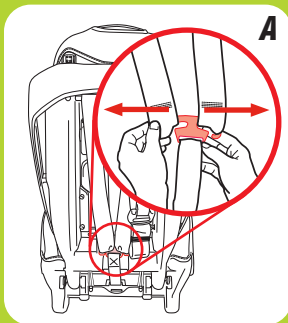

1. Remove the Seat Back

- A.** With the harness system loose, from the back of the seat, remove the harness straps from the splitter plate as shown.

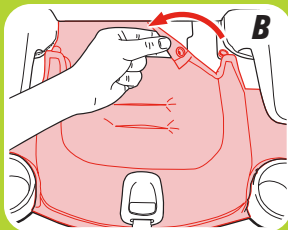

- B.** Lift seat pad to expose the seat base. Unhook the elastic loops from the back of the seat and unsnap seat pad from top of seat. From the sides of the seat, pull down on the tabs at the corners of the seat pad to remove from the keyholes. Pull the seat pad forward.

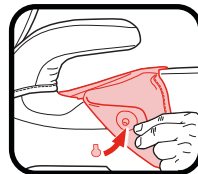
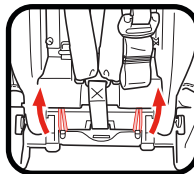

C. Push the buckle through the pad and store.

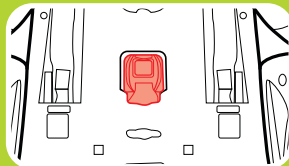
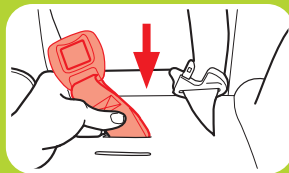

D. Release the back support by pulling the seat base pad forward to expose the seat base. Slide the 2 buttons towards the seat back and lower the seat back into a flat position.

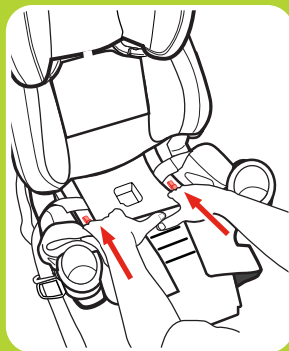

5-C Backless
Booster

5-C Backless Booster

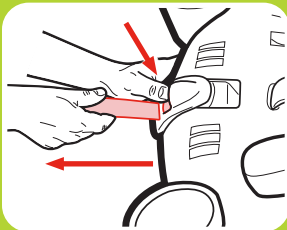
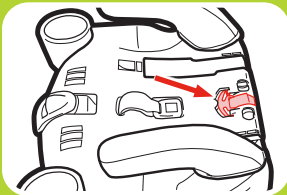
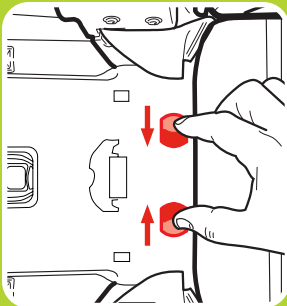

E. Squeeze the 2 buttons together and slide lower backrest out of the base.

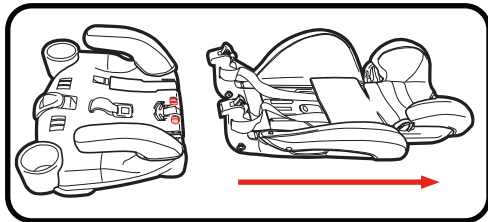

F. Store the splitter plate on the base of the seat.

G. Pull on the adjustment strap on the front of the seat to lock the splitter plate into place.

H. Replace the Seat Pads

Resnap the seat base pad. Attach the elastic loops at the back of the seat. Attach the seat pad to the key holes on the sides.

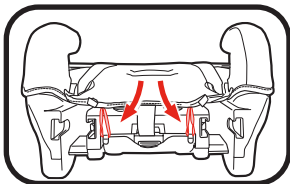

2. Place Booster Seat in the Most Upright Position

Pull the recline handle out and push down on front of seat. Put the booster seat in the most upright position.

3. Place Booster Seat Forward-Facing in Back Seat of the Vehicle

Place forward-facing on a vehicle seat that has a lap/shoulder seat belt. The bottom of the seat should sit as flat as possible on the vehicle seat.

See section 5-E to secure your child.

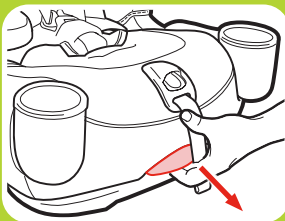
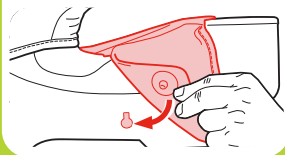
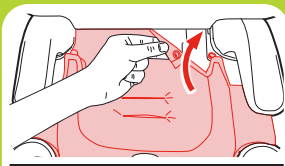

5-C
Backless
Booster



5-D Securing Child Highback Booster

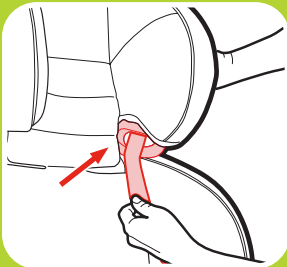

⚠ WARNING!

Use only the vehicle lap and shoulder belt system when restraining the child in the booster seat.

1. Place Child In Seat

Have your child sit in the booster seat, with his/her back flat against the back of the booster seat.

2. Thread Vehicle's Shoulder Belt Into Seat Belt Guide in the Headrest

3. Buckle the Vehicle Lap/Shoulder Seat Belt

Pull up on the shoulder belt to remove all the slack. Be sure the lap portion of the vehicle seat belt goes in front of the armrests.

Be sure the lap portion of the vehicle seat belt lies low across your child's hips.

Be sure the shoulder belt lies across your child's shoulders, between the neck and edge of shoulder. The belt guides should be even with or just above the shoulders.

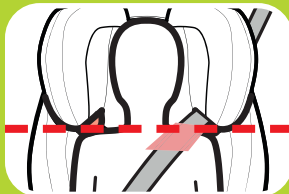
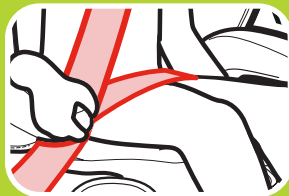
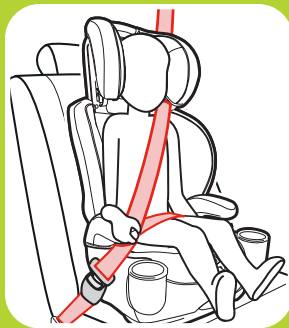

**5-D Securing Child
Highback Booster**



Is Everything Correct?



Never Use Lap Belt Only

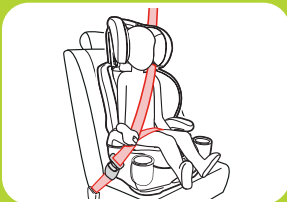

Lap Belt in Front of Armrest and Lies Low Across Hips and Thighs

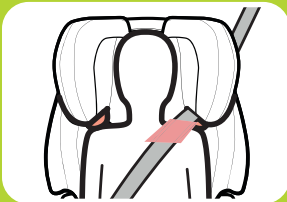

Shoulder Belt Lies On the Shoulder, Between the Neck and Edge of Shoulders

5-E Securing Child Backless Booster

⚠️ WARNING!

Use only the vehicle lap and shoulder belt system when restraining the child in the booster seat.

1. Place Child In Seat

Have your child sit in the booster seat, with his/her back flat against the back of the vehicle seat.

2. Ears Must Be Below the Top of the Vehicle Seat Back or Headrest

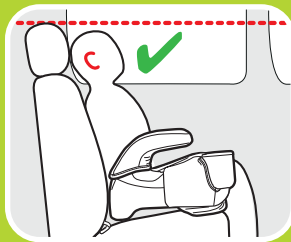

5-E
Securing Child
Backless Booster

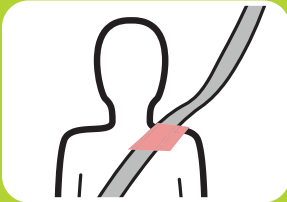

3. Buckle the Vehicle Lap/Shoulder Seat Belt

Pull up on the shoulder belt to remove all the slack. Be sure the lap portion of the vehicle seat belt goes in front of the armrests.

Be sure the lap portion of the vehicle seat belt lies low across your child's hips.

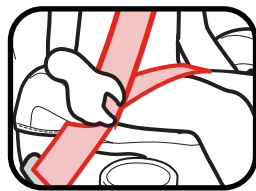

Be sure the shoulder belt lies across your child's shoulders, between the neck and edge of shoulder.

You may need to use the belt positioning clip to help get a good fit.

Is Everything Correct?

Never Use Lap Belt Only

Lap Belt in Front of Armrest and Lies Low Across Hips and Thighs

Shoulder Belt Lies On the Shoulder, Between the Neck and Edge of Shoulders

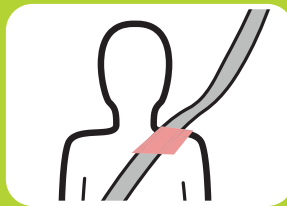

5-E Securing Child
Backless Booster

Using Belt Positioning Clip

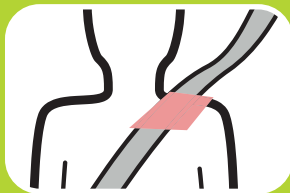

1. **Make Sure Vehicle's Seat Shoulder Belt Lays in the Red Zone As Shown**

If the vehicle's seat shoulder belt lays outside this zone, you **MUST** use the belt positioning clip. Do not use the belt position clip if the belt is already laying inside this zone.

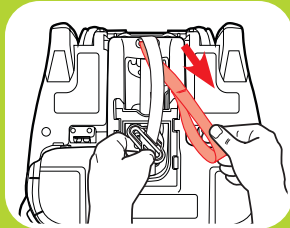

2. **Attach Belt Positioning Clip**

The shoulder belt positioning clip **MUST** be attached to the slot on the bottom of the base. Insert the loop end of strap through the slot on bottom of seat exactly where shown.

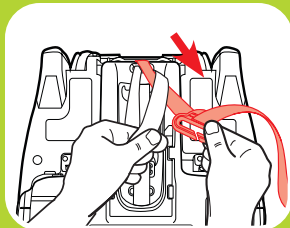

3. **Push Clip and Strap Through Loop**

Pass the clip and the strap through the loop end as shown and pull strap up.

4. Free End of Strap Should Face Front of Seat

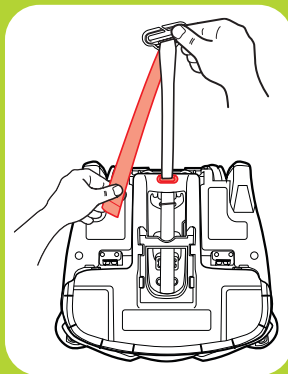

5. Place Child in Seat, Buckle Child In Seat and Attach Belt Positioning Clip

With child's back flat against the back of the vehicle seat, buckle child in. Then slide the clip onto the vehicle's seat shoulder belt as shown.

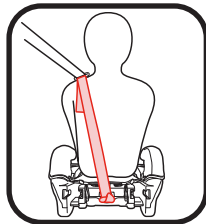

Rear View

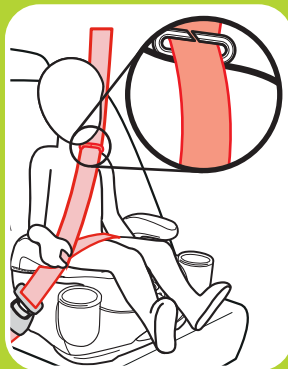

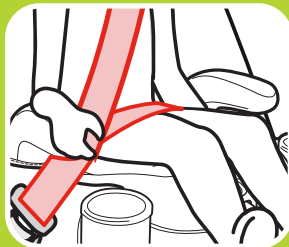
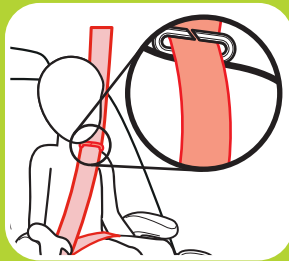
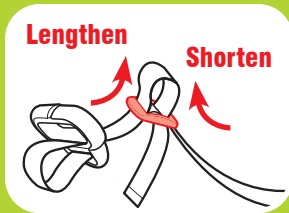

6. Adjust the Belt Positioning Clip to Fit Your Child

Lengthen or shorten the belt length as shown.

Clip should fit right at the top of shoulder as shown.

Pull up on the shoulder belt to remove all the slack. Be sure the lap portion of the vehicle seat belt goes in front of the armrests.

6-A Accessories *(on select models)*

Harness Covers

Make sure that harness covers do not interfere with placement of the chest clip at armpit level.

To remove, undo the fastening strips and remove.

Buckle Cover

To remove, unclip the buckle and slide cover over buckle

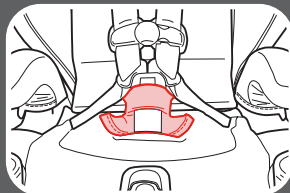
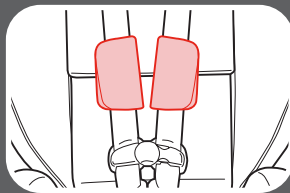

7-A How to Uninstall Lower Anchor Connectors and Tether

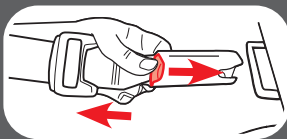

Lower Anchor Connectors

To remove the lower anchor connectors from the lower anchors, push in on the buttons and pull them off.

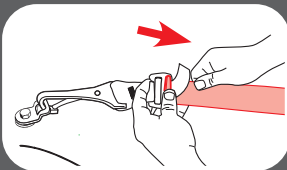

Tether

To remove, press the button and pull out on the strap to release the tension.

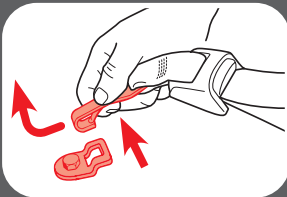

Press in on the hook's spring. Push tether hook in, then lift up and pull away from tether anchor.

7-B Choosing Vehicle Seat Location

Review your vehicle owner's manual for Seating Locations

The best seating location for this car seat is one that:

- Is recommended by your vehicle owner's manual, and
- Results in a secure installation of this car seat

In the event there is no available back seat and / or you have no other option, the National Highway Traffic Safety Administration (NHTSA) recommends that you take the following steps:

- Ensure the child is properly restrained according to their age and size
- Move the seat as far back as possible
- Make sure the child is not leaning out of position, such as leaning forward into the deployment path of the air bag
- Set the air bag ON-OFF switch, if available, to the OFF position

7-C Unsafe Vehicle Seat Location

Never install this car seat in any of the following vehicle seating locations:



rear-facing or side-facing vehicle seats



booster mode with vehicle lap belt only seat belt

7-D Vehicle Seat Belts

Review your vehicle owner's manual for vehicle seat belt use

This car seat can be installed using a vehicle seat belt. To do this, you will need to change the seat belt to a locked mode for use with car seats. With some vehicle seat belts, this is done with the latch plate; with other vehicle seat belts, this is done with the retractor.

Vehicle Seat Belt Terms

Retractor

A device that winds up the unused vehicle seat belt. It is often hidden inside the panels on the walls of the vehicle or in the vehicle seatback.

Latch Plate

The male end of the seat belt with the silver tongue.

Seat Bight

The crease where the vehicle seat back and seat bottom meet.

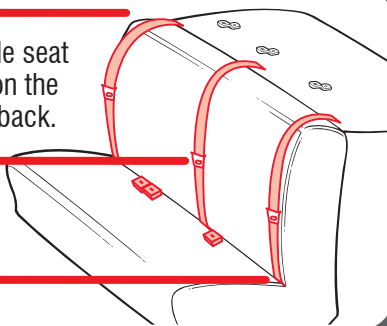

Identify Your Seat Belt Type

There are two different types of vehicle seat belts that can be used with this car seat:

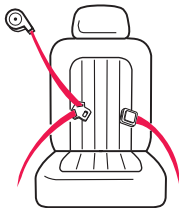

Lap/Shoulder Belt

3 connections points. Can be used in all car seats modes of use.

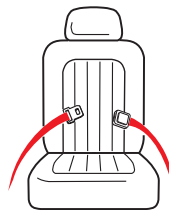

Lap Belt Only

2 connection points. **Can ONLY be used in harness mode.**

The following types of vehicle seat belts **CANNOT** be used safely with this car seat:



Lap Belt with Motorized Shoulder Belt



Lap Belt or Shoulder Belt Mounted on Door

Belts Forward of the Seat Bight



Some vehicles you may not get a secure fit. Read both your vehicle and car seat manuals.

Lap/Shoulder Belt Installation

Always review your vehicle owner's manual for specific information about your vehicle seat belts.

There are three types of retractors: **ELR (Emergency Locking Retractor)**, **ALR (Automatic Locking Retractor)**, and **Switchable (ELR switch to ALR)**. To determine your type of retractor, follow these steps:

1. **Slowly** pull the belt out about halfway and stop.
2. Let the belt retract back several inches.
3. Try to **slowly** pull the belt out more. If the belt cannot be pulled any further, it is **ALR**. If it can be pulled further, go to the next step.
4. **Slowly** pull the belt all the way out, and then allow it to retract several inches.
5. Try to pull the belt all the way out again. If it cannot be pulled out, it is **Switchable**. If it can still be pulled out freely, it is **ELR**.



Note: Most vehicles manufactured after 1996 will have Switchable retractors in the back seat. If you have any questions about your retractor type, consult your vehicle owner's manual or call Graco for assistance.



How to Lock Your Lap and Shoulder Vehicle Seat Belt

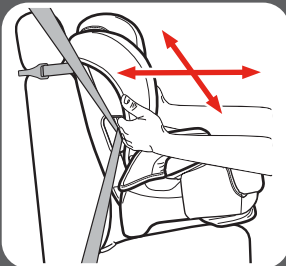
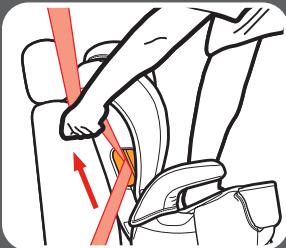

Sliding Latch Plate and Switchable Retractor

A latch plate that slides freely on the belt webbing and cannot, by itself, hold the belt snug around a car seat.

When installing the car seat, route the vehicle seat belt through the proper belt path and buckle it in. **Slowly pull the shoulder belt all the way out to switch it to locking mode.** Then, as you pull the vehicle seat belt tight, feed all the slack back into the retractor.

Grab the sides of the seat at the belt path and slide the seat side-to-side and front-to-back. The seat should not move more than 1" (2.5 cm).

Note: When using the lock-off, you are not required to switch the retractor as an installation step. The lock-off locks the seat belt. However, it is recommended to switch the retractor after the installation is complete to avoid a possible strangulation risk.

- When using the Snuglock® lock-off, route the vehicle seat belt into the proper belt path under the lock-off and buckle. Push down firmly on the center of the seat while pulling on the shoulder belt to remove the slack. Do not pull on the strap with excessive force. Close the Snuglock® lock-off. Test for tightness. Slowly pull the shoulder belt all the way out to switch it to locking mode.

Locking Latch Plate and ELR Retractor

A latch plate that holds the lap belt snug after it has been adjusted; contains a metal bar on the underside of the hardware that “locks” the belt in position.

When installing the car seat, route the vehicle seat belt through the proper belt path and buckle it in. Then, pull upwards on the shoulder belt so that the lap belt gets tight around the car seat.

Grab the sides of the seat at the belt path and slide the seat side-to-side and front-to-back. The seat should not move more than 1” (2.5 cm).

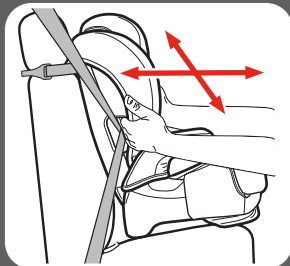
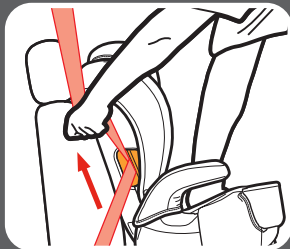
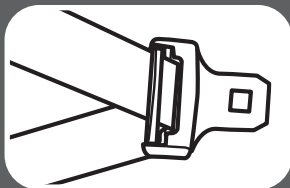

 **7** Additional Information

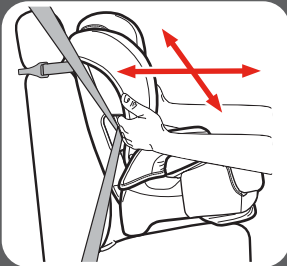
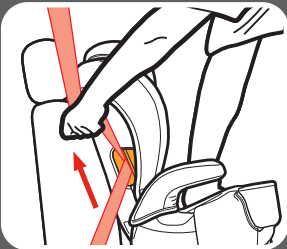
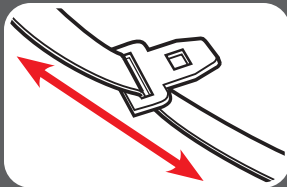

Sliding Latch Plate and ALR Retractor

A latch plate that slides freely on the belt webbing and cannot, by itself, hold the belt snug around a car seat.

Slowly pull the shoulder belt all the way out. Route the vehicle seat belt through the proper belt path and buckle it in. Then, as you pull the vehicle seat belt tight, feed all the slack back into the retractor.

Grab the sides of the seat at the belt path and slide the seat side-to-side and front-to-back. The seat should not move more than 1" (2.5 cm).

Sliding Latch Plate and ELR Retractor

A latch plate that slides freely on the belt webbing and cannot, by itself, hold the belt snug around a car seat.

With this retractor, you will need to use the locking clip to lock the vehicle seat belt.

Call us at 1-800-345-4109 to order a locking clip.

Route the vehicle seat belt through the proper belt path and buckle it in. Pull the vehicle seat belt tight. While pushing down on seat, pinch the two straps together behind the buckle tongue. Unbuckle the belt without allowing it to slip.

Attach locking clip to lap and shoulder belts as shown.

Rebuckle belt. Check that lap belt does not move by pulling hard. If belt loosens or lengthens, repeat procedure.

Note: If you use the SnugLock® lock-off, you do not need a locking clip.

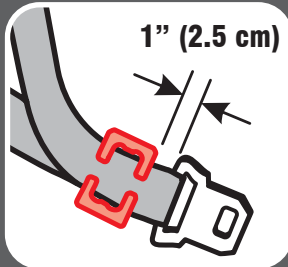
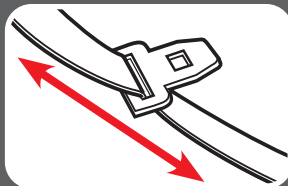

Lap Belt Installation - DO NOT use in Booster Mode

Always review your vehicle owner's manual for specific information about your vehicle seat belts.



Grab the sides of the seat at the belt path and slide the seat side-to-side and front-to-back. The seat should not move more than 1 " (2.5 cm).



Locking Latch Plate and No Retractor

When installing the car seat, route the lap seat belt through the proper path and buckle it in. Then, pull upwards on the tail of the belt so that the lap belt gets tight around the car seat.

Sewn On Latch Plate and ALR

Slowly pull the lap belt all the way out. Route the vehicle seat lap belt through the proper belt path and buckle it in. Then, pull the lap belt tight while feeding all the slack back into the retractor.

7-E Aircraft Installation

This child restraint is certified for use in aircraft when using the harness system, and **ONLY** when not using the SnugLock® lock-off.

This child restraint is not certified for aircraft use when used as a booster seat because aircrafts do not have shoulder belts.



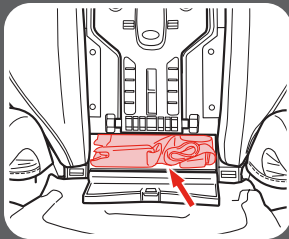

7
Additional
Informational

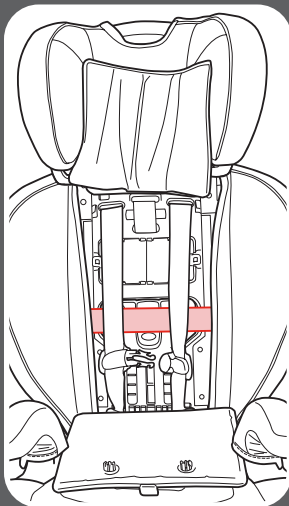

1. Store Lower Anchor Attachment in Storage Compartment

Open storage compartment and store lower anchor connectors. Close the storage compartment door.



2. Route the Aircraft Seat Belt Over the SnugLock® Lock-off

Thread the aircraft seat belt through the belt path and out the other side. Buckle it. The seat belt should lie as flat as possible and not be twisted. Make sure the aircraft seat belt is routed behind the harness straps.

Note: It may be easier to route the aircraft seat belt by lifting the seat pad up to expose the belt path.

For complete forward-facing installation, see section 3-C, but do not use the tether.

8-A Cleaning Seat Pad

Refer to seat pad care tag for washing instructions.

Headrest Pad

Clean with a damp sponge using mild soap and cool water. If needed, the headrest pad may be removed for cleaning.

To remove, raise the headrest to the highest position.

Pull plastic tab out of the back of the headrest.

Unhook the elastic loops from the back of the headrest.

Untuck headrest pad from below the headrest actuator on the front of the headrest.

Remove headrest pad.

Machine wash pad in cold water on delicate cycle and drip-dry. **DO NOT USE BLEACH.**

Reverse the steps to reattach the pad on the headrest.

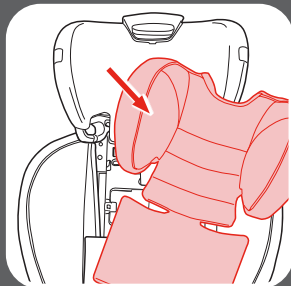
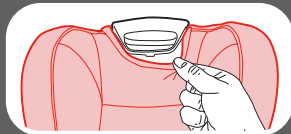
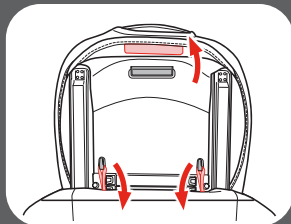

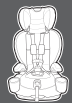

8 Care & Cleaning

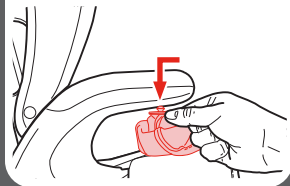
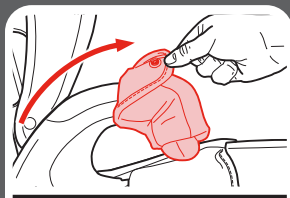
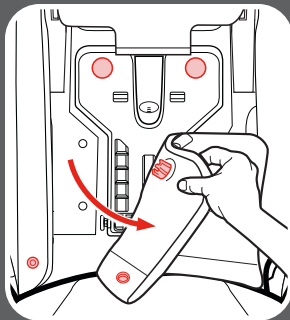

Lower Backrest Pad

Clean with a damp sponge using mild soap and cool water. If needed, lower backrest pad may be removed for cleaning.

To remove lower backrest pad, pull the top of the pad off the seat, undo both snaps and remove.

Machine wash pad in cold water on delicate cycle and drip-dry. **DO NOT USE BLEACH.**

Reverse the steps to replace the lower backrest pad.

Armrest Covers

Clean with damp sponge using mild soap and cool water. If needed, armrests covers may be removed for cleaning.

Undo snaps on the back of the armrest covers.

Push back on the tabs at the bottom of the armrest covers to remove from the keyholes.

Remove armrest covers.

Machine wash covers in cold water on delicate cycle and drip-dry. **DO NOT USE BLEACH.**

Reverse the steps to reattach the covers to the armrests.

Seat Pad

Clean with a damp sponge using mild soap and cool water. If needed, seat pad may be removed for cleaning.

To remove seat pad, unhook the elastic loops from the back of the seat.

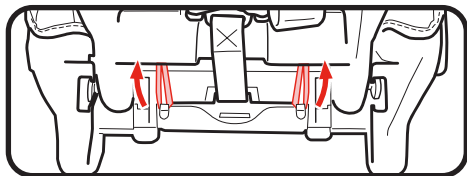

Unsnap the seat pad on both sides.

From the sides of the seat, pull down on the tabs at the corners of the seat pad to remove from the keyholes.

From the front of the seat, pull down on the tabs on the seat pad by the recline handle to remove from the keyholes. (Note: it may be easier to access the keyholes by reclining the car seat first).

Untuck seat pad from around the harness adjustment lever.

Lift the seat pad to remove.

Machine wash pad in cold water on delicate cycle and drip-dry. **DO NOT USE BLEACH.**

Reverse the steps to reattach the seat pad.

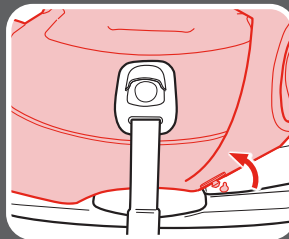
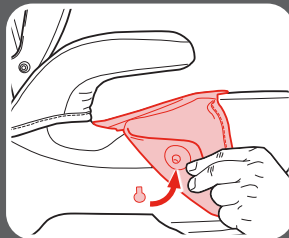
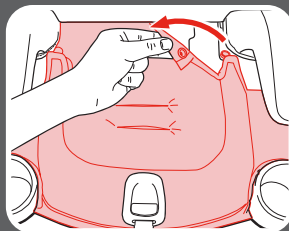



8 Care & Cleaning

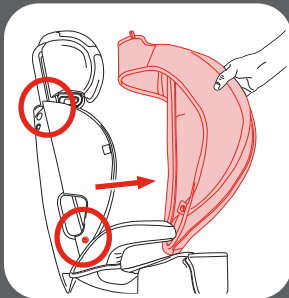
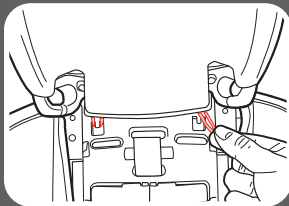
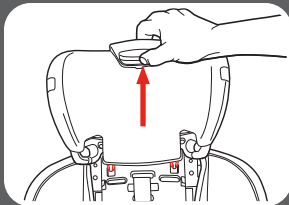

Side Pad

Clean with a damp sponge using mild soap and cool water.

Raise the headrest to the highest position.

Undo elastic loops from front of seat below the headrest.

Undo snaps above the armrests on the sides of the seat.

From the top, pull the pad off of the shell.

Machine wash pad in cold water on delicate cycle and drip-dry. **DO NOT USE BLEACH.**

Reverse the steps to reattach the side pad.

8-B Cleaning Buckle

From bottom of car seat, rotate metal retainer to side in order to push it through slot easier. Pull buckle strap from child restraint as shown.

To clean buckle, place in a cup of warm water and gently agitate the buckle. Press the red button several times while in the water.

DO NOT SUBMERGE THE BUCKLE STRAP. DO NOT USE SOAPS, HOUSEHOLD DETERGENTS or LUBRICANTS.

Shake out excess water and allow to air dry. Repeat steps as needed until it fastens with a click. Re-insert the buckle into the same slot it was removed. Pull up on buckle strap to make sure it is secured.

WARNING! Inspect and clean buckle from time to time to remove any objects or debris that could prevent latching.

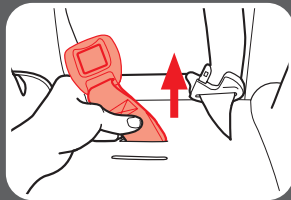
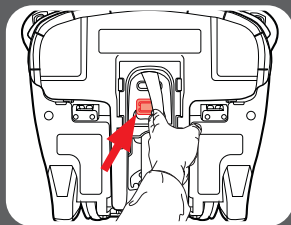

8-C Cleaning Harness, Lower Anchor Attachment and Tether

Surface wash only with mild soap and damp cloth. **DO NOT IMMERSE THE HARNESS STRAPS, LOWER ANCHOR STRAP, or TETHER STRAP IN WATER.** Doing so may weaken the straps.

If harness straps, lower anchor strap or tether strap are frayed or heavily soiled, contact Customer Service at www.gracobaby.com or 1-800-345-4109.

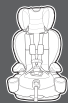

Notes

Replacement Parts

To purchase parts or accessories in the United States,
please contact us at the following:

www.gracobaby.com

or

1-800-345-4109

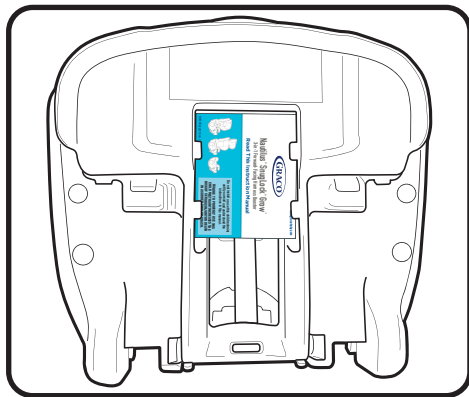

Store instruction
manual in the slot with
the instruction book
icon as shown.