

NWL0001633161A  
2/24

**GRACO**<sup>®</sup>  
*premier*

[www.gracobaby.com](http://www.gracobaby.com)

SNUGRIDE<sup>®</sup> SNUGFIT<sup>™</sup> LX  
INFANT CAR SEAT

## Read This Instruction Manual

Do not install or use this child restraint until you read and understand the instructions in this manual.

**FAILURE TO PROPERLY  
USE THIS  
CHILD RESTRAINT  
INCREASES THE  
RISK OF SERIOUS  
INJURY OR DEATH IN  
A SUDDEN STOP OR  
CRASH.**

**KEEP INSTRUCTIONS  
FOR FUTURE USE.**

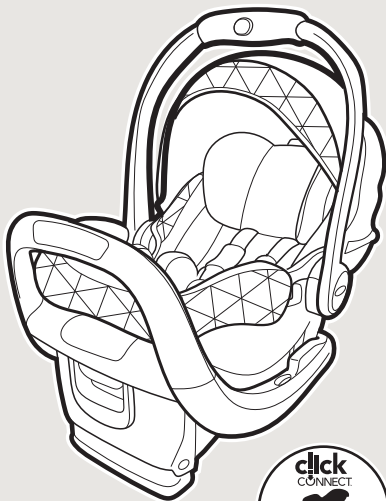

## **Important**

*Pages 4-11*

- 1-A Welcome to the Graco Family!**
- 1-B Safety Warnings**
- 1-C Aircraft Installation**

## **Features**

*Pages 12-19*

- 2-A Car Seat Features**
- 2-B Remove Car Seat from Base**
- 2-C Attach Car Seat to Base**
- 2-D Adjusting Carry Handle**
- 2-E Choosing Vehicle Seat Location**
- 2-F Which Installation Method Should I Use?**

## **Rear-Facing Use**

*Pages 20-40*

- 3-A Rear-Facing Checklist**
- 3-B Install With Base With Lower Anchor Attachment**
- 3-C Install With Base With Vehicle Seat Belt**
- 3-D Install Without Base With Vehicle Seat Belt**

## **Securing Child**

*Pages 41-50*

- 4-A Adjust Harness to Fit Child**
- 4-B Adjust Buckle to Fit Child**
- 4-C Securing Child in Car Seat**
- 4-D Removing Child**

## **Carrier Use**

*Pages 51-52*

## **Vehicle Information**

*Pages 53-57*

- 6-A How to Remove Lower Anchor Attachment**
- 6-B Unsafe Vehicle Seats**
- 6-C Vehicle Seat Belts**

## **Accessories**

*Page 58*

## **Care & Cleaning**

*Pages 59-63*

- 8-A Cleaning Seat Pad**
- 8-B Cleaning Buckle**
- 8-C Cleaning Harness and Lower Anchor Attachment**



1 Important

## 1-A Welcome to the Graco Family!

Your child's safety depends on you. **No car seat can guarantee protection from injury in every situation, but proper use helps reduce the risk of serious injury or death.**

**READ THIS MANUAL CAREFULLY.**

This child restraint meets or exceeds all applicable requirements of Federal motor vehicle safety standard 213 for use in motor vehicles.

Even if this car seat seems easy to figure out on your own, you must follow the detailed instructions in this instruction manual to ensure the steps are performed correctly.

### *If You Need Help*

In the U.S.A, please contact our Customer Service Department with any questions you may have concerning parts, use, or maintenance. When you contact us, please have your product's model number and date of manufacture ready so that we may help you efficiently. These numbers can be found on a sticker on the back side of your car seat.

Contact us at **[www.gracobaby.com](http://www.gracobaby.com) or call 1-800-345-4109.**

For additional resources or to get your car seat checked by a child passenger safety technician, please visit the following web sites:

[www.nhtsa.gov](http://www.nhtsa.gov) • [www.seatcheck.org](http://www.seatcheck.org) • [www.safekids.org](http://www.safekids.org)



1 Important

***This car seat is for children 4-30 lb (1.8-13.6 kg) and 30" (76 cm) or less.***

**Note:** Preterm or low birth weight infants may be at special risk in a vehicle or aircraft. According to the AAP, these infants may suffer breathing issues if improperly reclined in a car seat. Use the corrected age for preemies. Graco advises that you have your physician or hospital staff evaluate your infant and recommend the proper car seat or car bed before you and your infant leave the hospital.

### ***Register This Child Restraint***

Please fill out the prepaid registration postcard attached to the harness and mail it in today **or register online at [www.gracobaby.com/carseatregistration](http://www.gracobaby.com/carseatregistration).**

Child restraints could be recalled for safety reasons. You must register this restraint to be reached in a recall. Send your name, address, and the restraint's model number and manufacturing date to:

Graco Children's Products, Inc.  
Attn: Customer Service  
P.O. Box 169, Elverson, PA 19520-9901  
or call 1-800-345-4109  
**or register online at**  
**[www.gracobaby.com/carseatregistration](http://www.gracobaby.com/carseatregistration)**

For recall information, call the U.S. Government's Vehicle Safety Hotline at 1-888-327-4236 (TTY: 1-800-424-9153), or go to <http://www.NHTSA.gov>.



**1 Important**

For future reference or if you change addresses, record the model name, model number, date of manufacture, and purchase date of this car seat below. You can find this information either on the registration card if you still have it or on the date label located on the back of the car seat.

**Model Name** \_\_\_\_\_

**Model Number** \_\_\_\_\_

**Date of Manufacture** \_\_\_\_\_

**Date of Purchase** \_\_\_\_\_

## 1-B Safety Warnings



1 Important

### **! WARNING!**

Failure to follow these instructions and child restraint's labels can result in child striking the vehicle's interior during a sudden stop or crash.

**! According to accident statistics, children are safer when properly restrained in the rear seating positions than in the front seating positions. The center of the back seat can be the safest during a possible side impact.**



**! NEVER place this child restraint rear-facing in a vehicle seating location that has an active front air bag.**

If an air bag inflates, it can hit the child and car seat with great force and cause serious injury or death to your child.

- ! Review your vehicle owner's manual for more information about air bags and car seat use.**
- ! If your vehicle does not have a back seat, review your vehicle owner's manual.**
- ! Children are safer riding rear-facing and should ride rear-facing as long as possible, until they reach the maximum rear-facing height or weight rating for their car seat. Graco convertible and all-in-one car seats**

**have higher rear-facing limits that will allow children to ride rear-facing longer after outgrowing their infant car seat. Be sure to check your local and state laws, as well as AAP and NHTSA recommendations, for car seat usage.\***

- ! This child restraint must only be used with children weighing between 4-30 lb (1.8-13.6 kg).**
- ! Select a suitable location for the car seat in your vehicle.**
- ! Secure car seat with a vehicle seat belt or lower anchor attachment that is properly routed as shown in this manual.**
- ! Vehicle seat belt system MUST hold car seat securely. Not all vehicle seat belts can be used with a car seat.**
- ! If vehicle seat belt does not hold car seat securely, read “Vehicle Seat Belts” section 6-C and your vehicle owner’s manual.**
- ! Always secure car seat with lower anchor attachment or a vehicle seat belt, even when unoccupied. In a crash, an unsecured car seat can injure passengers.**
- ! DO NOT use car seat if it is damaged or missing parts.**

\*Graco Supports the American Academy of Pediatrics and National Highway Traffic Safety Administration’s Car Seat Guidelines. Visit [www.gracobaby.com/en-US/safety](http://www.gracobaby.com/en-US/safety) for information on car seat usage recommendations.





- ! If car seat is in a crash, it must be replaced. DO NOT use it again! A crash can cause unseen damage and using it again could result in serious injury or death.**
- ! DO NOT use accessories or parts other than those provided by Graco except for a thin towel or mat to protect your vehicle seat or rolled towels or pool noodles to help get your car seat level. Their use could alter the performance of the car seat.**
- ! DO NOT remove lower anchor attachment system from car seat. If using vehicle seat belt to secure car seat, lower anchor attachment connectors must be stored.**
- ! Never leave child unattended, even when sleeping. Child may become tangled in harness straps and suffocate or strangle.**
- ! Rear-facing car seat must be properly leveled:**
  - Too reclined can result in injury or ejection.**
  - Too upright can result in breathing difficulties.**
- ! Never attach two lower anchor attachment connectors to one vehicle lower anchor point unless specifically allowed by the vehicle manufacturer.**
- ! Do not use both the vehicle seat belt and lower anchor attachment strap at the same time when using the car seat rear-facing.**





## 1 Important

### ***Car Seat's Useful Life***

STOP using this car seat and throw it away 7 years after the date of manufacture. Look for date of manufacture label on back of the car seat.

Graco Children's Products Inc. advises against loaning or passing along a car seat unless you know the complete history of the product. We also advise against purchasing a car seat second hand.

### ***Warm Weather Use***

Car seat parts can get very hot in the sun or warm weather. **To avoid burns, always check before putting child in car seat.**

## 1-C Aircraft Installation



1 Important



This child restraint is certified for use in aircraft when used without the base. Use only on forward-facing aircraft seats. Follow the instructions for vehicle installation. See sections 3-D and 6-C Lap Belt Installation.

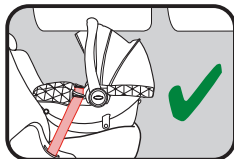

This child restraint's **base** is NOT certified for use in aircraft.

Contact the airline for their specific policies.

When installing the car seat, route the lap seat belt through the proper path and buckle it in. Then, pull on the tail of the belt so that the lap belt gets tight around the car seat.

Grab the sides of the seat at the belt path where the lap belt is and move the car seat from side-to-side and front-to-back. If it moves less than 1" (2.5 cm), it is tight enough.

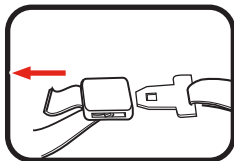

## 2-A Car Seat Features

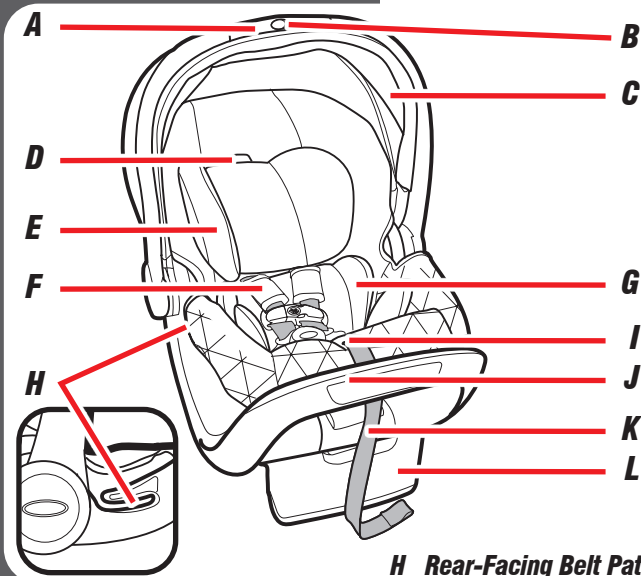

**A** Carry Handle

**B** Handle Adjustment Button

**C** Canopy

**D** Headrest Adjustment Lever

**E** Headrest

**F** Harness Covers

**G** Body Support

**H** Rear-Facing Belt Path  
(When Used Without Base)

**I** Harness Release Lever  
(Under Pad)

**J** Anti-Rebound Bar

**K** Harness Adjustment Strap

**L** Removable Base

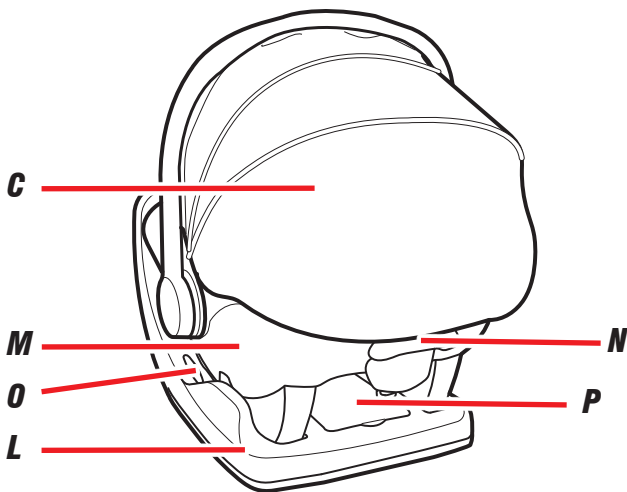

- M*** Car Seat Shell
- N*** Base Release Lever
- O*** Level Indicator
- P*** Instruction Manual and Lower Anchor Attachment Storage
- Q*** Harness Straps
- R*** Chest Clip
- S*** Buckle Tongues
- T*** Buckle
- U*** Buckle Strap

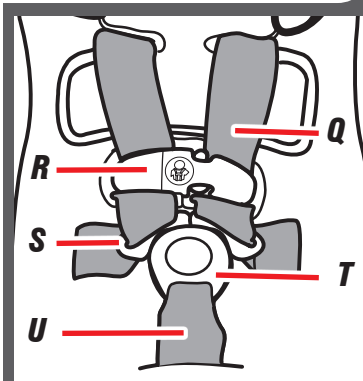

**2 Features**

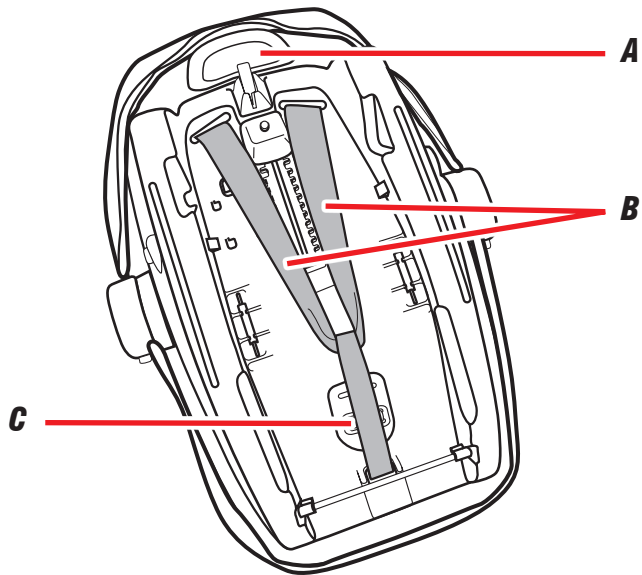

- A** *Base Release Lever*
- B** *Harness Straps*
- C** *Buckle Metal Clip*

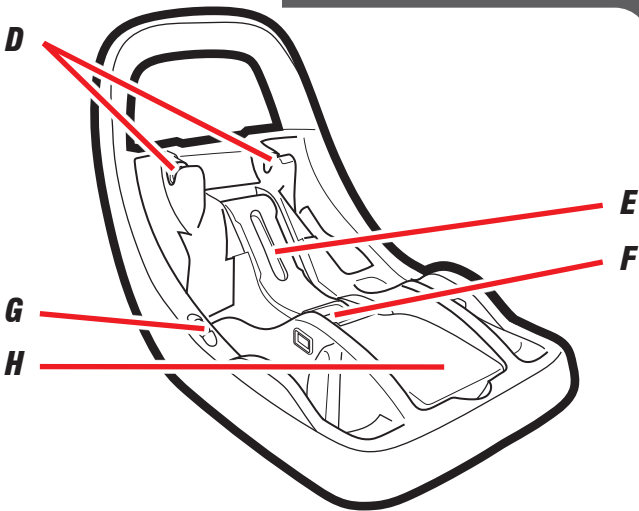

- D*** Car Seat Base Lock
- E*** SnugLock® Lock-Off
- F*** SnugLock® Lock-Off Release Lever
- G*** Level Indicator
- H*** Instruction Manual and Lower Anchor Attachment Storage
- I*** Anti-Rebound Bar
- J*** Base Recline Lever
- K*** Base Recline Foot

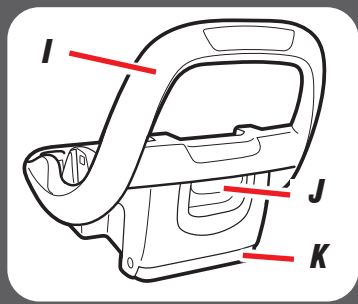

## 2-B Remove Car Seat from Base

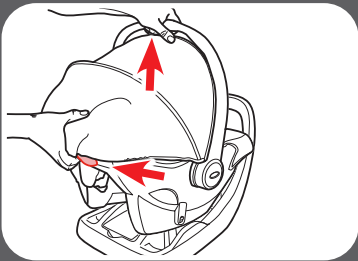

### ***To Remove Car Seat from Base***

From the back of the car seat, squeeze the base release handle and lift the car seat out of the base.

## 2-C Attach Car Seat to Base

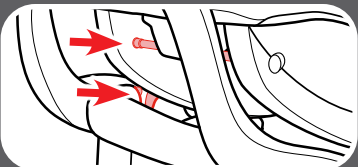

### ***Attaching Car Seat To Base***

Align the locking bar at the front of the car seat with the locks in the base. Set car seat in the base. Push down on the front of the car seat. You will hear a “click” when it is locked.

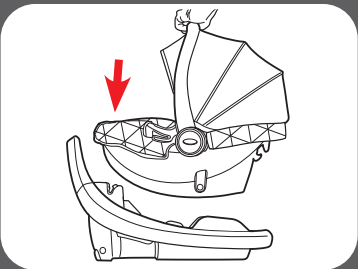

Pull up on the front corners of the seat to make sure it is locked.



## 2-D Adjusting Carry Handle

### 1. To Rotate Handle

Press the handle adjustment button at the top of the handle and rotate the handle. When moving from position A, handle will stop at position B. Release and push the button again to rotate the handle from position "B" to position "C" or "D".

MAKE SURE handle locks into position "A" before lifting the carrier.

### 2. Handle Has 4 Positions

Rotate handle to any of the 4 locked positions. Push and pull the handle to make sure handle is in a lock position.

Carry handle **MUST** be upright in position A when carrying.

Handle can be in any position when used in the vehicle.

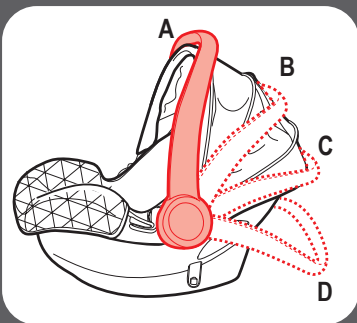
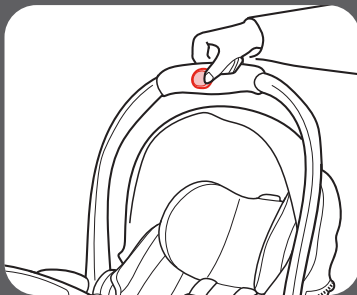

## 2-E Choosing Vehicle Seat Location

*Review your vehicle owner's manual for seating locations. Review section 6 for additional information.*

Some vehicles have specific requirements for where the car seat can be installed. Be sure to check your vehicle owner's manual for all available seating positions.

2 Features

### **⚠ WARNING!**



**NEVER place this child restraint rear-facing in a vehicle seating location that has an active front air bag.**

In the event there is no back seat, review your vehicle owner's manual to see how to use your infant child restraint.

## 2-F Which Installation Method Should I Use?

This car seat can be installed in your vehicle using either the vehicle seat belt OR the lower anchor attachment system. Both systems are equally safe to use. **DO NOT USE BOTH AT THE SAME TIME.**

This infant car seat carrier can be installed in your vehicle using only the vehicle seat belt. Lower anchor attachment is not available to install the carrier.

The lower anchor attachment system allows you to securely attach your car seat in your car without using the vehicle seat belt and possibly to get a better fit. All 2003 and newer model year vehicles are required to have a lower anchor attachment system, although some manufacturers began including lower anchor attachment earlier. Some vehicle owner manuals use the term ISOFIX to identify the lower anchor attachment system. Review section 6 for additional information.

***Review your vehicle's owner manual for exact location and use. Review section 6 for additional information.***

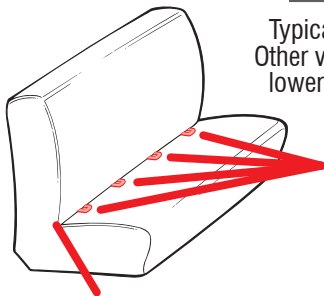

**Vehicle Seat Crease**

Typical seat in a passenger vehicle.  
Other vehicle types may have different lower anchor attachment locations.

**Vehicle Lower Anchor**

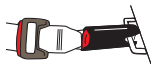

## 3-A Rear-Facing Checklist

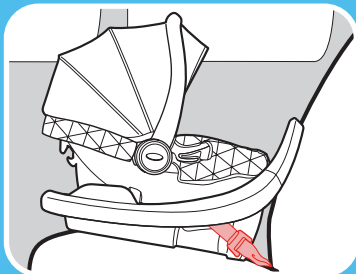

**Lower Anchor Attachment Strap**

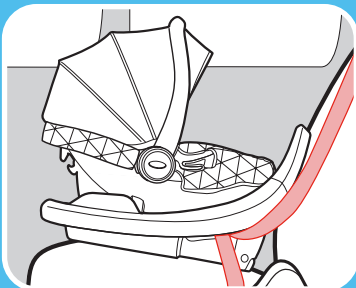

**Vehicle Lap/Shoulder Seat Belt**

**Rear-Facing:  
4-30 lb (1.8-  
13.6 kg) 30"  
(76 cm) or less**



- Car seat **MUST** be rear-facing in the vehicle back seat.
- Make sure lower anchor attachment strap or vehicle seat belt is routed through the rear-facing belt path, marked with a blue label.
- Install this car seat tightly in your vehicle. Car seat **should not move** at the belt path more than 1" (2.5 cm) from side to side and front to back.
- Make sure to check the level indicator or level line for proper recline.
- Harness straps must be **at or just below** the top of child's shoulders and chest clip must be at **armpit level**.
- Make sure base is a minimum of 80% on vehicle seat.

Children are safer riding rear-facing and should ride rear-facing as long as possible, until they reach the maximum rear-facing height or weight rating for their car seat. Graco convertible and all-in-one car seats have higher rear-facing limits that will allow children to ride rear-facing longer after outgrowing their infant car seat. Be sure to check your local and state laws, as well as AAP and NHTSA recommendations, for car seat usage.

**⚠ WARNING!**



**NEVER**  
place this  
child  
restraint  
rear-facing in a  
vehicle seating  
location that has an  
active front air bag.

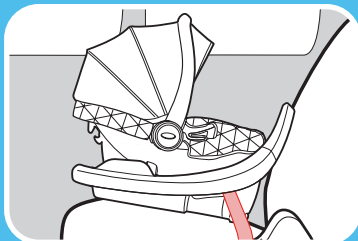

**Vehicle Lap Only Seat Belt**

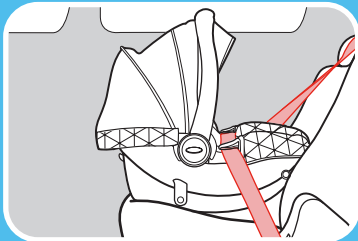

**Vehicle Lap/Shoulder  
Seat Belt Without Base**

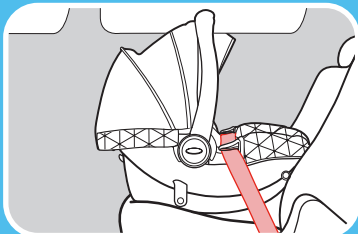

**Vehicle Lap Only Seat Belt  
Without Base**



## **3-B Install With Base With Lower Anchor Attachment**

***Review your vehicle owner's manual for lower anchor attachment location and use.***

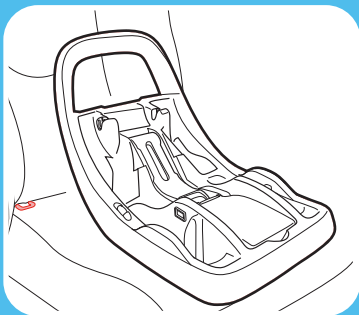

### **1. Place Base in Back Seat of the Vehicle**

Place the base flat on the vehicle seat. Push it back until the anti-rebound bar touches the vehicle seat back. Center the base between the lower anchor attachment anchors.

If allowed by your Vehicle Owner's Manual, the center seating position may be used if the anchor spacing is 11" (28 cm) or greater.



**3 Rear Facing**

## **2. Remove the Lower Anchor Attachment Connectors from Storage Location**

Open the lower anchor attachment storage door and pull out the lower anchor attachment strap.

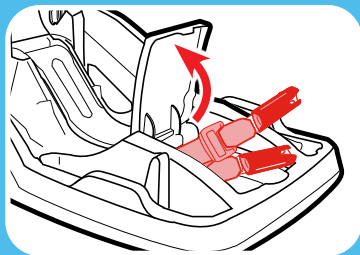

Close the Door.

## **3. Open the SnugLock® Lock-Off**

Push in the release lever and open the lock-off.

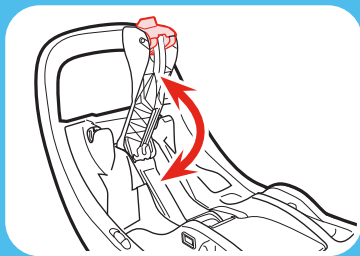
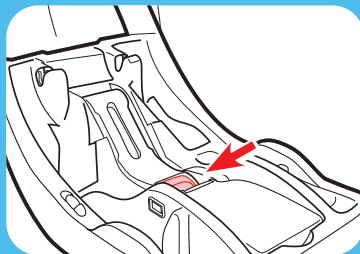

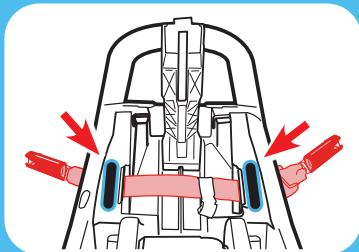

**4. Route the Lower Anchor Attachment Strap through the Rear-Facing Belt Path, Marked With a Blue Outlined Label**

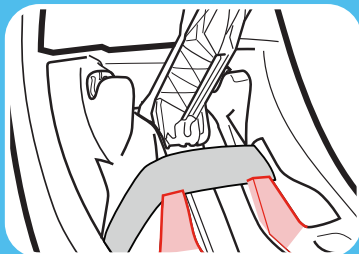

**5. Make sure the strap is threaded above the notches near the lock-off.**

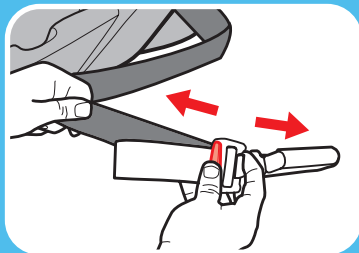

**6. Extend the Lower Anchor Attachment Strap**

Extend the lower anchor attachment strap to its maximum length by pressing the gray button and pulling on the strap.



## 7. Check the Level Indicator

Vehicle **MUST** be on level ground.

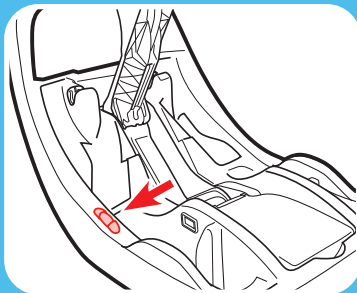

Use corrected age for preemies.

- If the bubble is entirely under the light blue line, the restraint is level for infants 0+ months in age.

- If the bubble is entirely under the dark blue line, the restraint is level for a child 3+ months in age.

- If the bubble is not completely under the blue lines, the child restraint is NOT level. You must adjust your recline position.



0+ months (meses)



3+ months (meses)



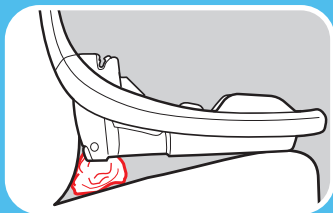
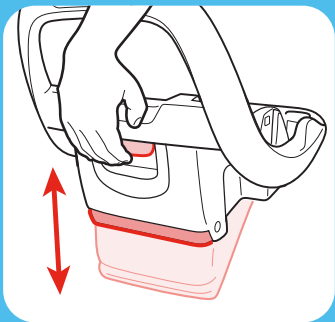

## 8. Recline the base

If the bubble in the level indicator is not under the correct line for your child's age, you must adjust the recline position.

To adjust the recline, squeeze the base recline lever on the front of the base and lift or lower the base to the appropriate recline.

Recheck the level indicator.

When the foot is completely extended and the level indicator is not correct for your child's age, you may raise the foot and place a rolled towel or pool noodle under the foot until the indicator shows correctly.

**9. Connect Lower Anchor Attachment Connectors to Vehicle's Lower Lower Anchor Attachment Anchors**

Lower anchor attachment strap should lay as flat as possible and not be twisted.

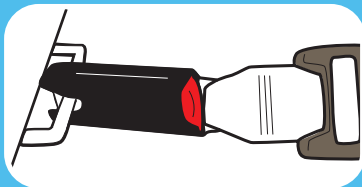

**10. Remove the Slack**

Press down firmly on the top of the base while pulling on the free end of the lower anchor attachment strap to remove all the slack.

Do not pull on the strap with excessive force.

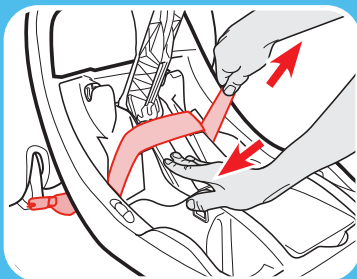

**3 Rear Facing**

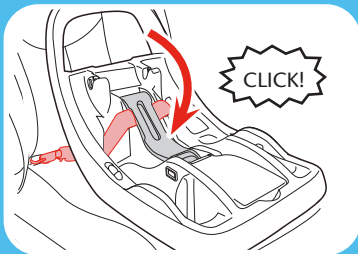

### 11. Close the SnugLock® Lock-Off

Shut the lock-off on top of the lower anchor attachment strap.

Close the lock-off until you hear a “Click”.

## **!WARNING!**

**Keep hands away from the lock-off area when closing the lock-off.**

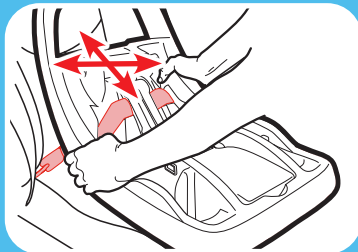

### 12. Test For Tightness

Grab the sides of the base at the belt path, push and pull the base from side to side and front to back.

If the base moves less than 1” (2.5 cm), it is tight enough.

### 13. Attach Car Seat to Base

Place car seat into the base. Push down on the front of the car seat and handle until you hear a “click”.

Test to make sure the car seat is attached by pulling up on the front corners of car seat.

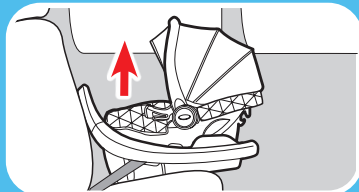
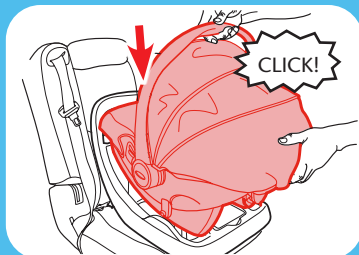

### 14. Check the Level Indicator

Vehicle **MUST** be level with the ground.

Check the level indicator with child in the child restraint.

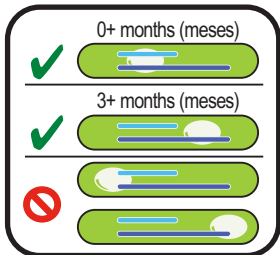
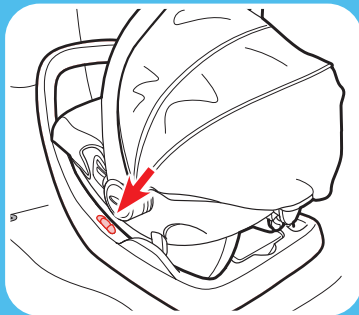

3 Rear Facing

## 3-C Install With Base With Vehicle Seat Belt

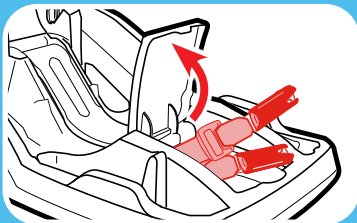

### 1. **Store Lower Anchor Attachment Strap**

Open the storage door and insert the lower anchor attachment strap as shown. Close the storage door.



### 2. **Place Base in Back Seat of the Vehicle**

Place the base flat on the vehicle seat. Push it back until the anti-rebound bar touches the vehicle seat back.



### 3. **Open the SnugLock® Lock-Off**

Push in the release lever and open the lock-off.

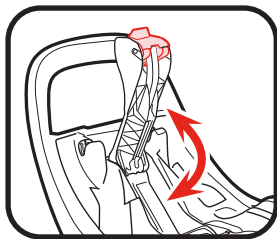

3 Rear Facing

#### 4. Check the Level Indicator

Vehicle **MUST** be level with the ground.

Use corrected age for preemies.

- If the bubble is entirely under the light blue line, the restraint is level for infants 0+ months in age.

- If the bubble is entirely under the dark blue line, the restraint is level for a child 3+ months in age.

- If the bubble is not completely under the blue lines, the child restraint is NOT level. You must adjust your recline position.

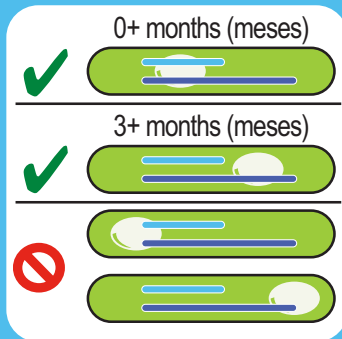
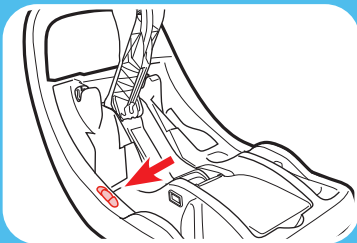

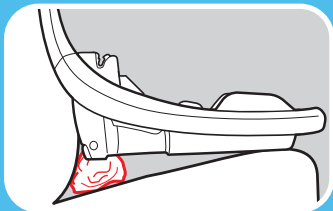
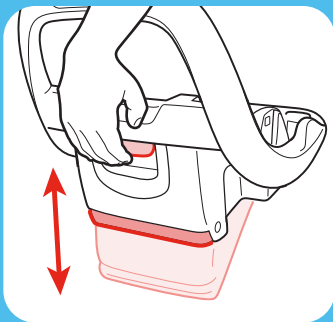

### **5. Recline the base**

If the bubble in the level indicator is not under the correct line for your child's age, you must adjust the recline position.

To adjust the recline, squeeze the base recline lever on the front of the base and lift or lower the base to the appropriate recline.

Recheck the level indicator.

When the foot is completely extended and the level indicator is not correct for your child's age, you may raise the foot and place a rolled towel or pool noodle under the foot until the indicator shows correctly.



## **6. Route the Vehicle Seat Belt**

Thread the lap portion of the vehicle seat belt through the rear-facing belt path (marked with a blue label) and buckle it. The seat belt should lay as flat as possible and not be twisted.

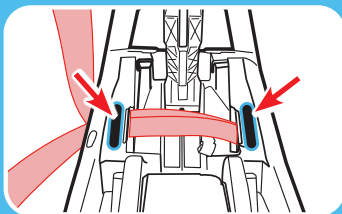
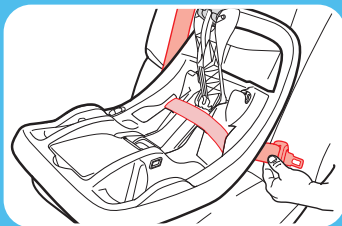

## **7. Make sure the strap is threaded above the notches near the lock-off.**

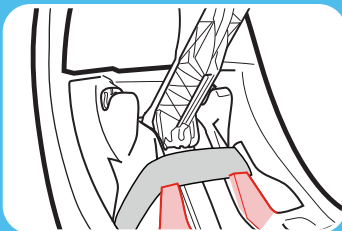

**3 Rear Facing**

**Review your vehicle's owner's manual for vehicle seat belt use**



**8. Tighten the Vehicle Seat Belt**

Press down firmly on the top of the base while pulling on the shoulder belt to remove the slack.

Do not pull on the strap with excessive force.

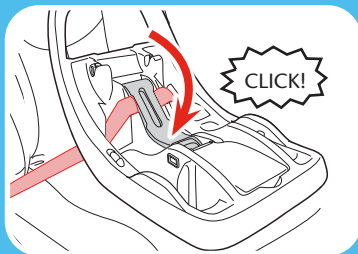

**9. Close the SnugLock® Lock-Off**

Push down on the arm until you hear the latch click.



**3 Rear Facing**

**⚠ WARNING!**

**Keep hands away from the lock-off area when closing the lock-off.**

## 10. Test For Tightness

Grab the sides of the base where the seat belt is and push and pull the base from side to side and front to back.

If the base moves less than 1" (2.5 cm), it is tight enough.

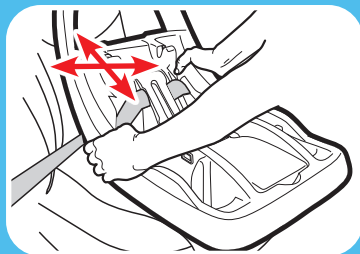

## 11. Attach Car Seat to Base

Place car seat into the base. Push down on the front of the car seat and handle until you hear a “click”.

Test to make sure the car seat is attached by pulling up on the front corners of car seat.

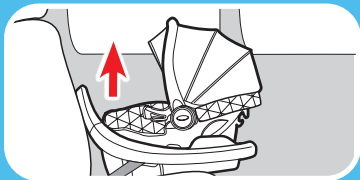
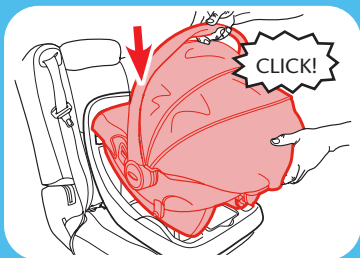

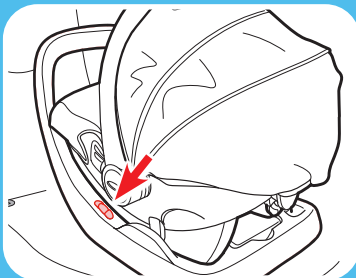

0+ months (meses)



3+ months (meses)



## 12. Check the Level Indicator

Vehicle **MUST** be on level ground.

Check the level indicator with child in the child restraint.

## 3-D Install Without Base With Vehicle Seat Belt

### 1. Place Car Seat in Back Seat of the Vehicle

Place the car seat on the vehicle seat. Push it back until the front of the car seat touches the vehicle seat back.

Check the rear-facing level line. The red level line on the side of the seat **MUST BE LEVEL** with the ground.

If needed, rolled towels may be placed under the base, at the vehicle seat crease, until the level line is level with the ground.

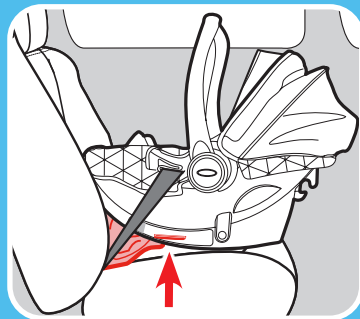
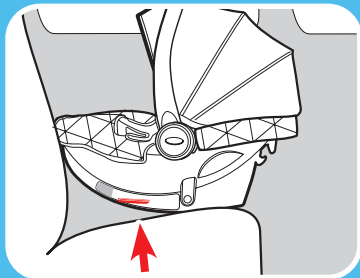

3 Rear Facing

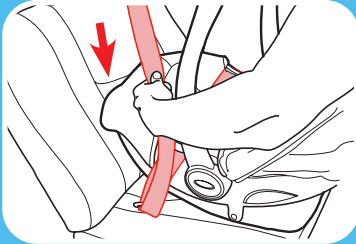
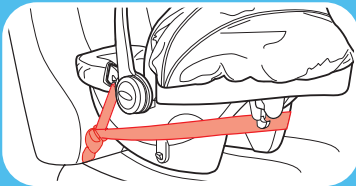
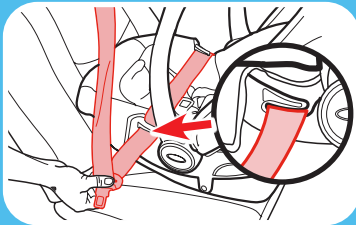

## 2. *Route the Vehicle Seat Belt*

Thread vehicle seat belt through the rear-facing belt path (marked with a blue label) and buckle it. The seat belt should not be twisted.

If your shoulder belt is long enough, you may route the shoulder belt behind the seat as shown.

## 3. *Lock the Vehicle Seat Belt*

In most vehicles today, **slowly pull the shoulder belt all the way out** and then let it go back in. You will hear a “clicking” sound. Slowly pull out on the belt and it should be locked. If not, review your car’s owner manual and section 6-C.

#### 4. **Tighten the Vehicle Seat Belt**

Lay your forearm across the car seat **at the belt path and push down**. Pull on the shoulder belt to tighten while feeding the slack back in the retractor.

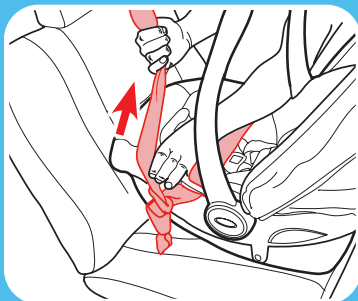

#### 5. **Test For Tightness**

Grab the sides of the car seat where the seat belt is and push and pull the car seat from side to side and front to back.

If the car seat moves less than 1" (2.5 cm), it is tight enough.

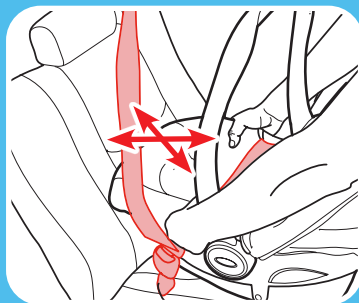

**3 Rear Facing**



3 Rear  
Facing

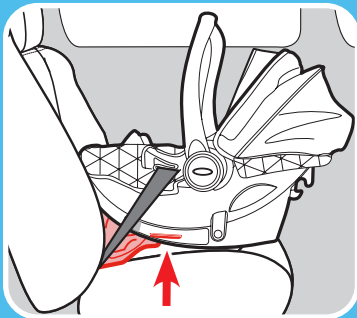
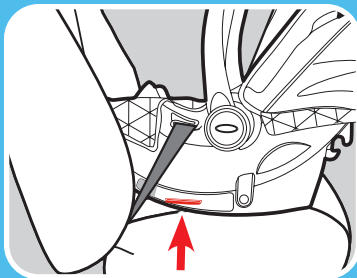

## 6. Check the Rear Facing Level Line

The red level line on the side of the seat **MUST BE LEVEL** with the ground.

Check the level line with child in the child restraint when making sure the line is level with the ground.

If needed, rolled towels may be placed under the car seat, at the vehicle seat crease, until the level line is level with the ground.



## 4-A Adjust Harness to Fit Child



### 4 Securing Child

#### 1. Loosen Harness Straps

Push the harness release button (under seat pad) while pulling out on the harness straps at the chest clip.

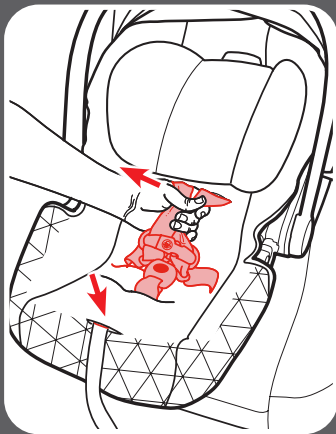

#### 2. Release the Chest Clip

Squeeze the chest clip release buttons and pull apart.

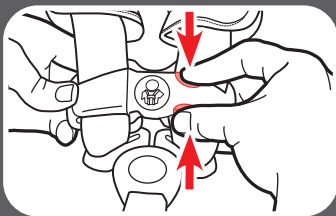



## 4 Securing Child

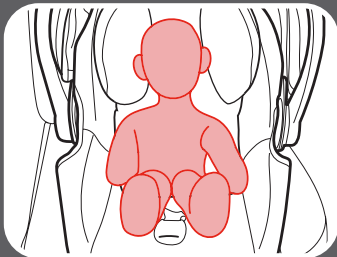

### 3. **Unbuckle the Buckle**

Press the red button and pull buckle tongues out. Place harness straps off to the sides.

### 4. **Place Your Child in the Seat**

Make sure their back is flat against the car seat back.

## **! WARNING!**

**WARNING! In cold weather, do not put snowsuits or bulky garments on your child when placing them in the car seat.** Bulky clothing can prevent the harness straps from being tightened properly. To keep child warm, buckle your child in the car seat and place a blanket around the child or place the child's coat on backwards after buckling in.

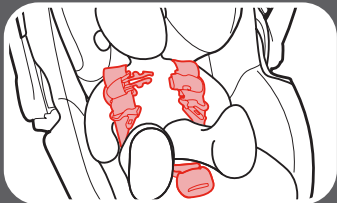

### 5. **Place Harness Straps Over Child's Shoulders**



## 4 Securing Child

### 6. Check Harness Height

Harness Straps **MUST BE AT OR JUST BELOW** the Child's Shoulders

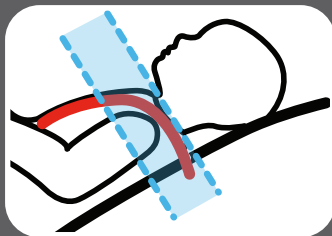

### 7. Top of Head **MUST BE AT LEAST 1" (2.5 cm) BELOW** the Top of the Car Seat

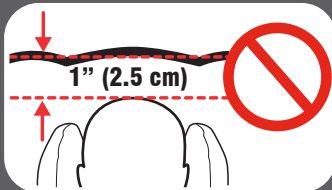

### To Change Harness Height:

Remove child from child restraint and loosen the harness straps.

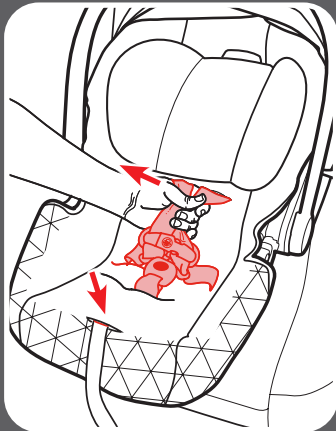



## 4 Securing Child

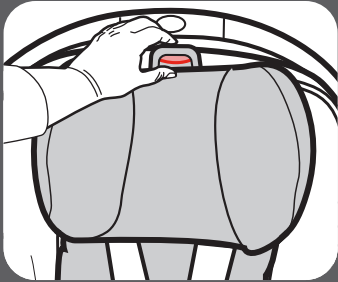

Squeeze the headrest adjustment button as shown.

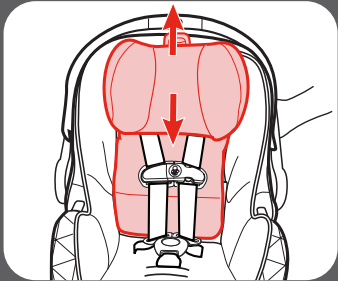

Move the headrest up or down to the proper harness height position.

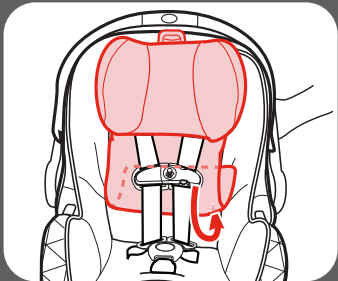

For smaller babies, shorten headrest by placing the bottom of the flap under the support as shown.

## 4-B Adjust Buckle to Fit Child



### 4 Securing Child

#### 1. *Check the Buckle Position*

The correct slot is the one that is closest to your child without being underneath them.

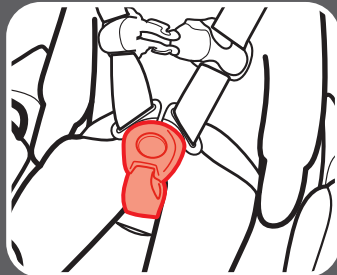

#### 2. *To Change Buckle Position*

Remove child from the seat. From the bottom of car seat, insert the buckle's metal clip up through shell and pad.

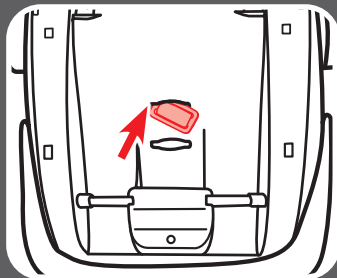

From the front, pull buckle out of the pad and shell.

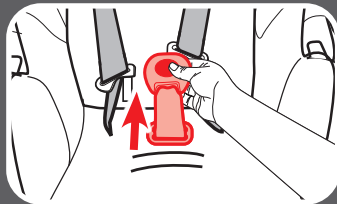



## 4 Securing Child

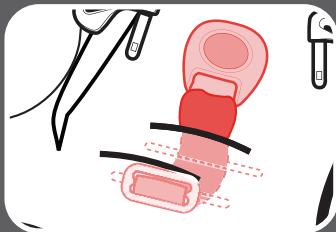
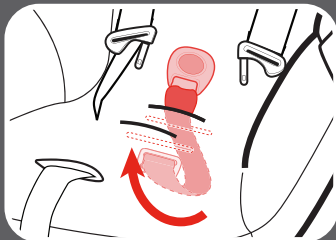
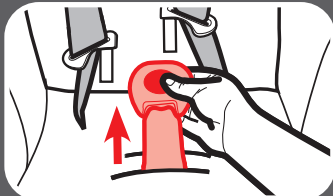
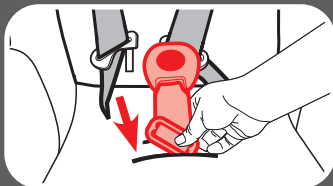

### 3. **Insert Metal Clip Into New Location**

Push metal clip down through the pad and shell. Make sure the buckle's red button is facing out.

### 4. **Pull Up On Buckle To Check It Is Secured**

Make sure buckle's metal clip is completely through pad and shell.

### **To Shorten Buckle for Low Birth Weight Infants:**

(Minimum weight is 4 lb (1.8 kg)):

When crotch strap clip is in rear crotch slot, insert clip into front crotch slot in seat but not through seat pad.

Crotch strap clip should remain flat against seat.

## 4-C Securing Child in Car Seat



### 4 Securing Child

#### 1. *Place Harness Straps Over Child's Shoulders*

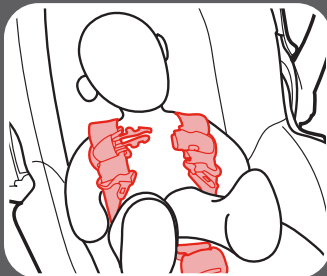

#### 2. *Buckle*

You will hear a “click” when buckle tongues are securely attached. Pull up on each buckle tongue to make sure it is securely attached.

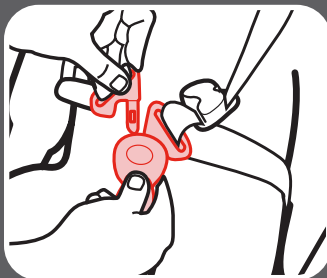

#### 3. *Buckle the Chest Clip*

You will hear a “click” when the chest clip is securely buckled attached.

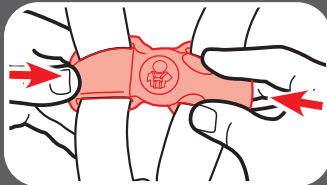



## 4 Securing Child

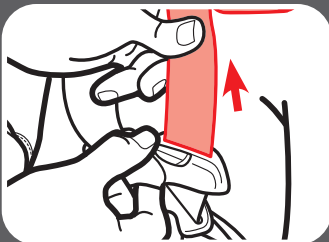

### **4. Pull All the Slack Out From Around the Waist**

Pull up on the harness strap while pushing the chest clip down. Do this to both sides.

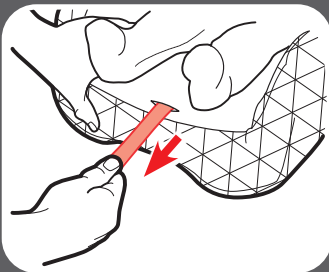

### **5. Tighten the Harness by Pulling the Adjustment Strap**

When you are not able to pinch any of the harness webbing at your child's shoulder, the harness is tight enough.

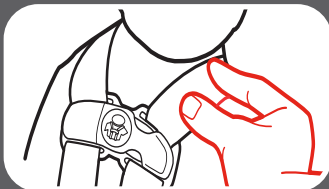

A snug harness should not allow any slack. It lies in a relatively straight line without sagging. It does not press on the child's flesh or push the child's body into an unnatural position.



**6. Raise the Chest  
Clip to Child's  
Armpit Level**

**7. Check Tightness**

Tighten more if needed.

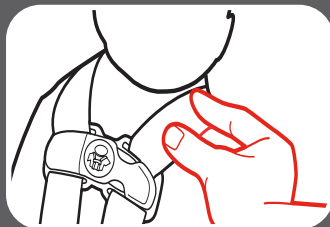
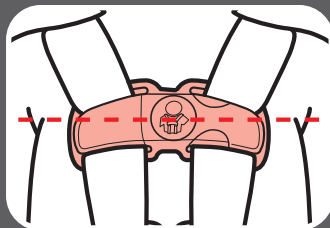

**4 Securing  
Child**



## 4 Securing Child

# 4-D Removing Child

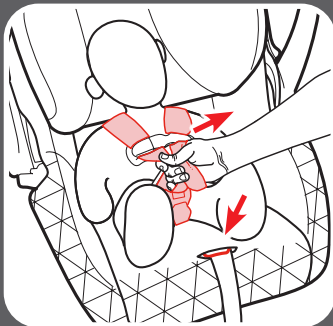

### 1. *Loosen Harness Straps*

Push down on the harness release lever under the seat pad while pulling out on the harness straps at the chest clip.

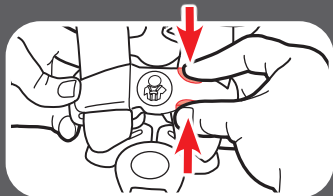

### 2. *Release the Chest Clip*

Squeeze the chest clip release buttons and pull apart.

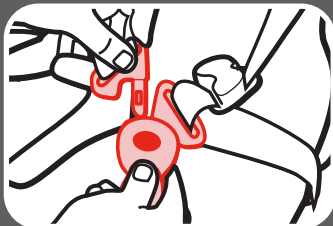

### 3. *Unbuckle Your Child*

Press in on the red button and remove the buckle tongues. Remove Child from the seat.

## 5-A Carrier Use

### **WARNING!**

**Read all instructions before use of the infant carrier. Keep instructions for future use.** Do not use the infant carrier if it is damaged or broken.

**NEVER** leave child unattended. Always stay within arms reach of carrier.

**SUFFOCATION HAZARD:** Infant carrier can roll over on soft surfaces and suffocate child. **NEVER** place carrier on beds, sofas, or other soft surfaces.

**STRANGULATION HAZARD:** Children have **STRANGLERD** in loose or partially buckled harness straps. Fully restrain the child even when carrier is used outside the vehicle.

**FALL HAZARD:** Child's movements can move carrier. **NEVER** place carrier on counter tops, tables or any other elevated surfaces.

**KEEP STRINGS AND CORDS AWAY FROM CHILD.** Strings and cords can cause strangulation. **DO NOT** place carrier near windows where cords from blinds or drapes can strangle a child. **DO NOT** hang strings on or over the carrier. **DO NOT** attach strings to toys.



5 Carrier  
Use

## **! WARNING!**

### **Fall Hazard:**

**The carrier can fall from a shopping cart. Do not use on a shopping cart.**



### **USE ONLY WITH STROLLERS WITH THE GRACO CLICK CONNECT LOGO.**

Refer to the stroller owner's manual for details on how to attach the infant carrier to your stroller. If you do not have an owner's manual, please visit our website at **[www.gracobaby.com](http://www.gracobaby.com)** to download the manual or call toll-free at 1-800-345-4109.



**NEVER** use a Graco infant carrier with any other manufacturer's strollers. This can result in serious injury or death.

## 6-A How to Remove Lower Anchor Attachment

**1. Push Button In While Pulling on Lower Anchor Attachment Strap to Loosen**

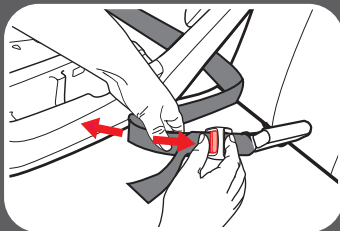

**2. Press and Hold Lower Anchor Attachment Release Button**



**3. Pull Away From Anchor Point**

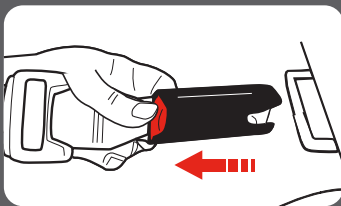

## 6-B Unsafe Vehicle Seats

Never install this car seat in side-facing or rear-facing vehicle seats.



## 6-C Vehicle Seat Belts

*Review your vehicle owner's manual for vehicle seat belt use*

This car seat can be installed using a vehicle seat belt. To do this, you will need to change the seat belt to a locked mode for use with car seats. With some vehicle seat belts, this is done with the latch plate; with other vehicle seat belts, this is done with the retractor.

## Vehicle Seat Belt Terms

### Retractor

A device that winds up the unused vehicle seat belt. It is often hidden inside the panels on the walls of the vehicle or in the vehicle seat back.

### Latch Plate

The male end of the seat belt with the silver tongue.

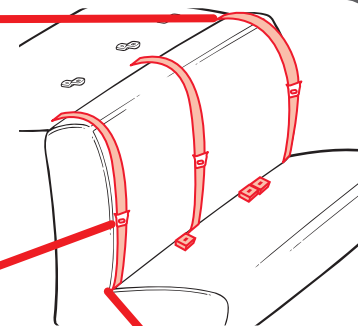

### Seat Crease

The crease where the vehicle seat back and seat bottom meet.

## Identify Your Seat Belt Type

There are two different types of vehicle seat belts that can be used with this car seat:

### Lap/Shoulder Seat Belt

3 connection points.

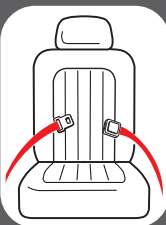
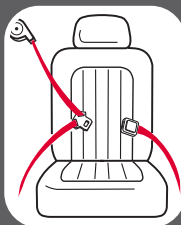

### Lap Only Seat Belt

2 connection points.

55

The following types of vehicle seat belts **CANNOT** be used safely with this car seat:



Lap Belt with Motorized  
Shoulder Belt



Lap Belt or Shoulder Belt  
Mounted on Door

Belts Forward of the  
Seat Crease

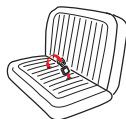

Some vehicles you may  
not get a secure fit.  
Read both your vehicle  
and car seat manuals.



## Lap/Shoulder Seat Belt Installation

**Always review your vehicle owner's manual for specific information about your vehicle seat belts.**

Most vehicles manufactured after 1996 will have Switchable retractors in the back seat. If you have any questions about your retractor type, consult your vehicle owner's manual, call Graco or visit [www.gracobaby.com/vehicle-seatbelt-information](http://www.gracobaby.com/vehicle-seatbelt-information).

To verify you have a Switchable retractor, **slowly** pull the belt all the way out, and then allow it to retract several inches. Try to pull the belt all the way out again. If it cannot be pulled out, it is **Switchable** retractor. Follow the steps in the rear-facing sections in this manual.

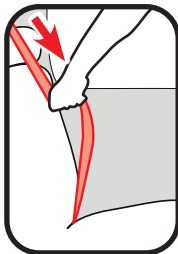

## 7-A Accessories (on select models)

### **!WARNING!**

**To prevent ejection in sudden stop or crash:  
The body support can ONLY be used for infants 12 lb  
(5 kg) or less.**

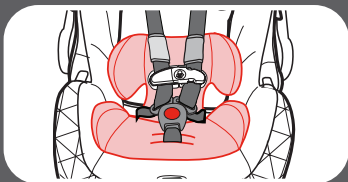

### **Body Support**

To remove, pull the body support out from behind the harness straps.

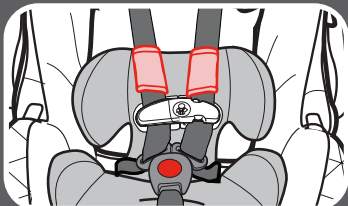

### **Harness Covers**

Make sure that harness covers do not interfere with the placement of the chest clip at armpit level.

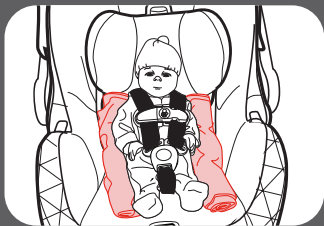

If your model does not include a body support, you can use a rolled towel as shown.

## 8-A Cleaning Seat Pad

### 1. Remove Canopy

Undo the snaps on the sides of the canopy from the seat pad.

Push the release button on the canopy arm while pulling on the canopy to remove.

Repeat on the other side.

Undo the fastening strips under the rear of the canopy.

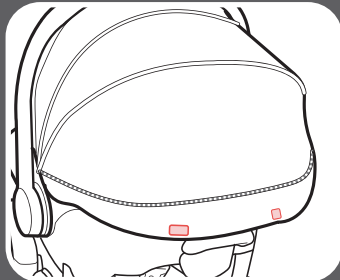
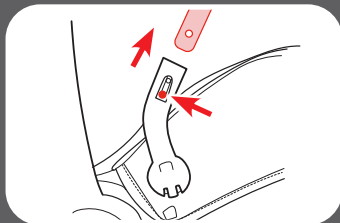
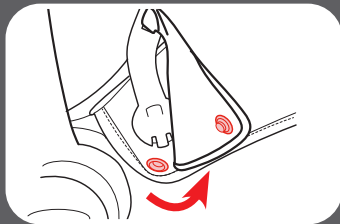

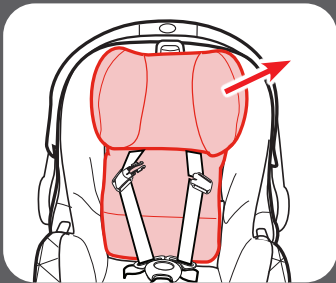

## **2. Headrest Pad**

Pull out from around harness straps and pull pad away from headrest.

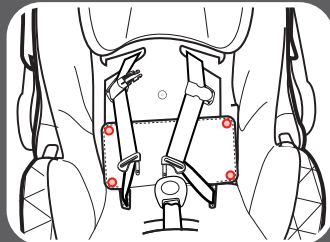

## **3. Seat Pad Snaps**

Unfasten the 4 snaps on the seat pad.

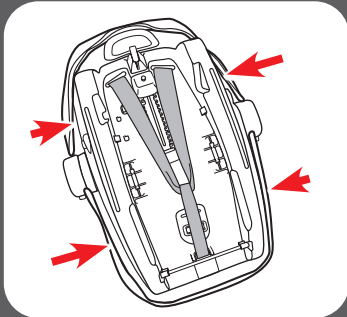

## **4. Pull Out the 4 Plastic Flaps from Sides of Seat**

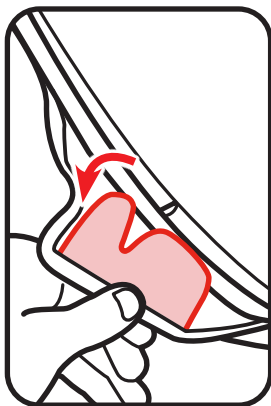

### **5. Pull Pad Off Shell**

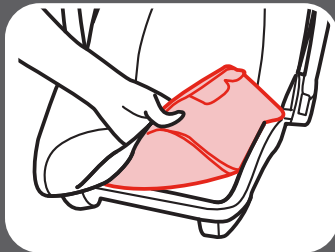
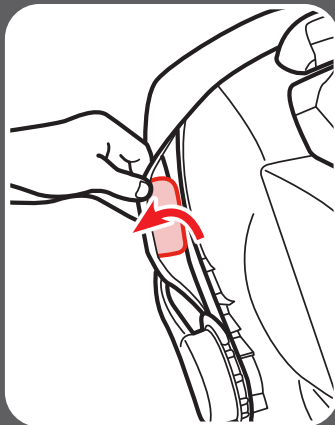

Machine wash pad and canopy in cold water with gentle soap on delicate cycle and drip-dry. **DO NOT USE BLEACH.**

Reverse the steps to reattach the pad to the shell. Make sure harness straps are not twisted.

## 8-B Cleaning Buckle

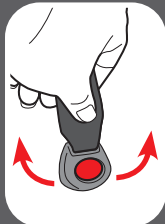
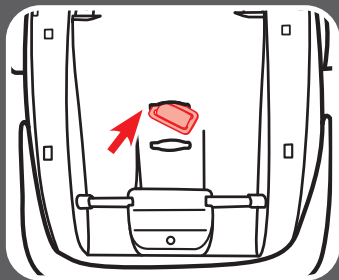

### **Remove Buckle to Clean**

From the bottom of car seat, insert the buckle's metal clip up through shell and pad. From the front, pull buckle out of the pad and shell.

To clean, place in a cup of warm water and gently agitate the buckle. Press the red button several times while in the water.

**DO NOT SUBMERGE THE BUCKLE STRAP.** DO NOT USE SOAPS, HOUSEHOLD DETERGENTS or LUBRICANTS.

Shake out excess water and allow to air dry. Repeat steps as needed until it fastens with a click. Re-insert the buckle into the same slot it was removed. Pull up on crotch buckle to make sure it is secured.

**WARNING!** Inspect and clean buckle from time to time to remove any objects or debris that could prevent latching.

## 8-C Cleaning Harness and Lower Anchor Attachment

Surface wash only with mild soap and damp cloth. **DO NOT IMMERSE THE HARNESS STRAPS or LOWER ANCHOR ATTACHMENT STRAP IN WATER.** Doing so may weaken the straps.

If harness straps or lower anchor attachment strap are frayed or heavily soiled, contact Customer Service at [www.gracobaby.com](http://www.gracobaby.com) or 1-800-345-4109.

8 Care  
& Cleaning

## Replacement Parts

To purchase parts or accessories in the United States,  
please contact us at the following:

**[www.gracobaby.com](http://www.gracobaby.com)**

**or**

**1-800-345-4109**

---

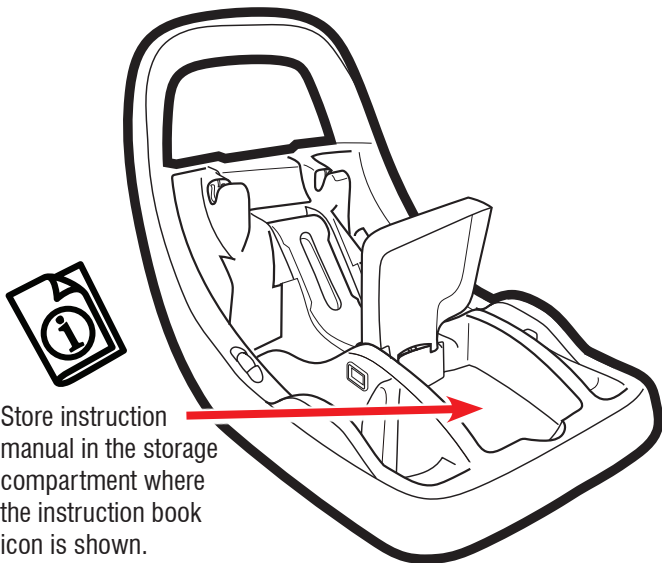

Store instruction manual in the storage compartment where the instruction book icon is shown.