

NWL0001320544E 4/23

www.gracobaby.com



TURN2ME™

3-IN-1 CAR SEAT

Read This Instruction Manual



Do not install or use this child restraint until you read and understand the instructions in this manual.

FAILURE TO PROPERLY USE THIS CHILD RESTRAINT INCREASES THE RISK OF SERIOUS INJURY OR DEATH IN A SUDDEN STOP OR CRASH.

1 Important

Pages 6-29

- 1-A Quick Guide to Your Manual**
- 1-B Welcome to the Graco Family**
- 1-C Right Mode of Use**
- 1-D Before You Begin**
 - Register This Child Restraint
 - If You Need Help
 - Certification
 - Car Seat's Useful Life
 - Vehicle Seat Protection
 - Warm Weather Use
- 1-E Safety Warnings**

2 Features

Pages 30-41

2-A Features

2-B Car Seat Rotation

3 Rear-Facing

Pages 42-65

3-A Rear-Facing Use

3-B Install Rear-Facing with Lower Anchor Attachment

3-C Install Rear-Facing with Vehicle Seat Belt

4 Forward-Facing

Pages 66-91

4-A Forward-Facing Use

4-B Install Forward-Facing with LATCH

4-C Install Forward-Facing with the Vehicle Seat Belt

5 Securing Child

Pages 92-101

5-A Securing Child 5-Point Harness

6 Booster

Pages 102-120

6-A Booster Use

6-B Install Highback Booster

6-C Securing Child Highback Booster

7 Accessories

Pages 121-122

8 Additional Information

Pages 123-137

- 8-A How to Uninstall Lower Anchor Connectors and Tether**
- 8-B Choosing Vehicle Seat Location**
- 8-C Unsafe Vehicle Seat Location**
- 8-D Vehicle Seat Belts**
- 8-E Aircraft Installation**

9 Care & Cleaning

Pages 138-144

- 9-A Cleaning Seat Pad**
- 9-B Cleaning Crotch Buckle**
- 9-C Cleaning Harness, Lower Anchor Attachment and Tether**

1-A Quick Guide to Your Manual



Important

1

This car seat is for children: *Rear-Facing: 4-40 lb (1.8-18.1 kg)*
Forward-Facing: 22-65 lb (10-30 kg)
Booster: 40-100 lb (18.1-45 kg)

- Children less than 22 lb (10 kg) **MUST** use this car seat rear-facing. Review section 1-C for more information.

Note: Preterm or low birth weight infants may be at special risk in a vehicle or aircraft. According to the AAP, these infants may suffer breathing issues if improperly reclined in a car seat. Graco advises that you have your physician or hospital staff evaluate your infant and recommend the proper car seat or car bed before you and your infant leave the hospital.

Install Cup Holders (Adult Assembly Required)

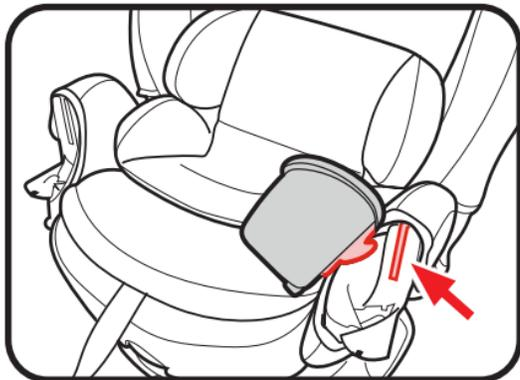

Cup holders *MUST* be installed.

To attach the cup holders, slide the hook on the cup holder into the slot in the seat, then rotate the bottom of the cup holder down until you hear a “CLICK!”.

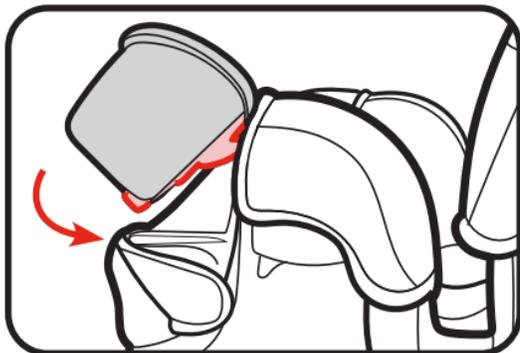

1 Important

Get to Know Your Car Seat

Review section 2-A to see all of the features of this car seat.

What Seating Location Should I Use?

The best seating location for this car seat is one that:

- Is recommended by your vehicle owner's manual, and
- Results in a secure installation of this car seat.

Some vehicles have specific requirements for where the car seat can be installed, so be sure to check your vehicle owner's manual for available seating positions, if any. For example, sometimes the center rear seat has a lap belt only vehicle seat belt, which cannot be used when this car seat is in Booster mode.

Review section 8-B, 8-C and 8-D of this manual AND your vehicle owner's manual.

WARNING!



NEVER place this child restraint rear-facing in a vehicle seating location that has an active front air bag.

In the event there is no back seat, review your vehicle owner's manual to see how to use your child restraint.



According to accident statistics, children are safer when properly restrained in the rear seating positions than in the front seating positions. The center of the back seat can be the safest during a possible side impact.



1
Important

Which Installation Method Should I Use?

This car seat can be installed in your vehicle using either the vehicle seat belt **OR** the lower anchor attachment. Both are equally safe to use. **INSTALL USING ONLY ONE METHOD.**

Graco allows the securing of the car seat with LATCH system in the booster mode, only if the vehicle manufacturer allows it. The child still **MUST BE SECURED** with the vehicle lap/shoulder seat belt.

Vehicle Seat Belt: Review section 8 and your vehicle owner's manual to learn how to install your car seat with the vehicle seat belts.

LATCH or Lower Anchor Attachment: The LATCH system or lower anchor attachment allows you to securely attach your safety seat in your car without using the vehicle seat belt and possibly to get a better fit. All 2003 and newer model year vehicles are required to have a LATCH system, although some manufacturers began including LATCH earlier. Some vehicle owner's manuals use the term ISOFIX to identify the LATCH system.

What is LATCH?



Important

1

LATCH consists of lower anchors and a tether anchor, which are built in to your vehicle, and a lower anchor attachment and a tether that are built in to your car seat. The lower anchor attachment is used **INSTEAD** of the vehicle's seat belt to secure the child seat to the vehicle. The tether is used **IN ADDITION** to the lower anchor attachment **OR** the vehicle's seat belt to secure a forward-facing car seat to the vehicle.

Review your vehicle owner's manual for exact location and use.

Vehicle's Tether Anchor

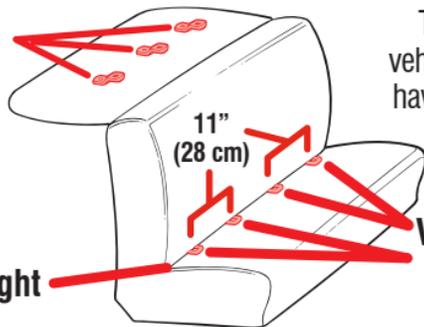

Typical seat in a passenger vehicle. Other vehicle types may have different lower anchor and tether anchor locations.

Vehicle Seat Bight

Vehicle's Lower Anchor



When Installing Rear-Facing or Forward-Facing

Lower Anchor Attachment

The lower anchor attachment consists of lower anchors, which are built in to your vehicle, and lower anchor connectors that are built in your car seat.

Review section 3-B, 4-B of this manual AND your vehicle owner's manual before installing.

Lower anchor attachment can ONLY be used if the vehicle lower anchor spacing is 11 inches (28 cm) from the center of one lower anchor to the center of the other lower anchor.

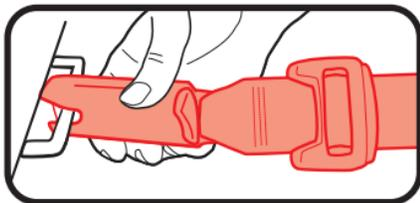
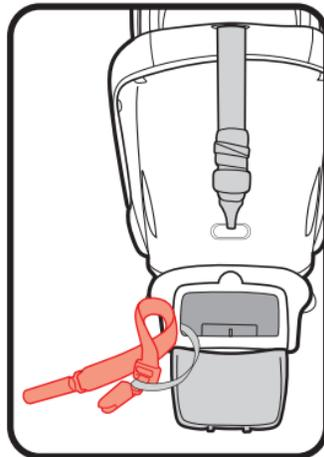

1 Important



Important

1

When Installing Rear-Facing or Forward-Facing (continued)

Vehicle Seat Belt

There are two types of vehicle seat belts that can be used. Lap/Shoulder Seat Belt or Lap Only Seat Belt.

Review section 3-C, 4-C and 8 of this manual AND your vehicle owner's manual before installing.

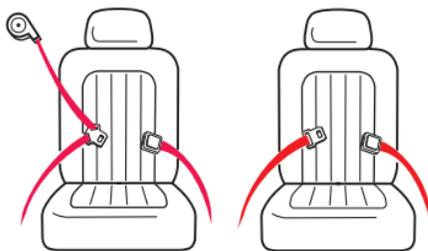

When Installing As a Booster

Vehicle Seat Belt

Only use the Lap/Shoulder seat belt configuration.

Review section 6-B, 6-C, and 8 of this manual AND your vehicle owner's manual.



Does Your Car Seat Fit Your Child Correctly?

To make sure your child is secured properly, review section 3, 4, 5 and 6 to understand all of the actions you need to take to properly adjust the car seat to fit your child.

For Rear-Facing, You Need to Adjust:

Harness Height, Rear-Facing

Harness straps at or just below the child's shoulders (A). Top of head **must** be 1" (2.5 cm) below the headrest adjustment lever (B).

Review section 5.

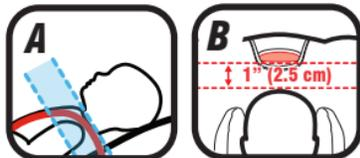

Buckle Position (C)

The correct slot is the one that is closest to your child without being underneath them.

Review section 5.

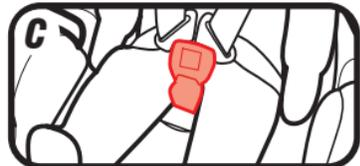

Harness Tightness (D)

If your fingers slide off the harness straps without pinching the straps, it is tight enough.

Review section 5.



1 Important



1 Important

For Forward-Facing, You Need to Adjust:

Harness Height, Forward-Facing

Harness straps at or just above the child's shoulders **(A)**. Top of child's ears below top of headrest **(B)**.

Review section 5.

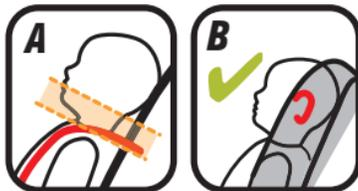

Buckle Position (C)

The correct slot is the one that is closest to your child without being underneath them.

Review section 5.

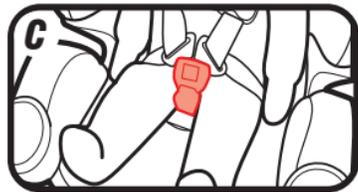

Harness Tightness (D)

If your fingers slide off the harness straps without pinching the straps, it is tight enough.

Review section 5.



For Booster, You Need to Adjust:

Use Lap/Shoulder Belt Only

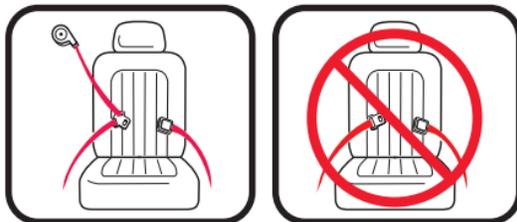

Position Lap Belt

Lap belt must go behind armrest and lie low across your child's hips and thighs.

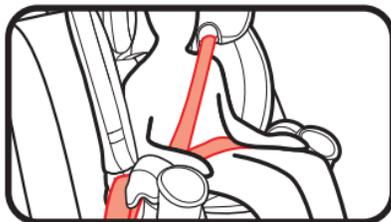

Position Shoulder Belt

Shoulder belt lies across shoulder between neck and edge of shoulder.

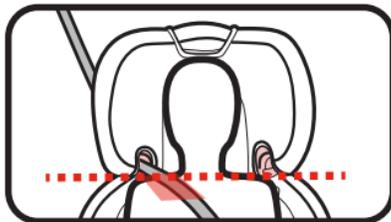

i
1 Important

Did You Do Everything Correctly?

Rear-Facing

Car Seat Rotated to the Rear-Facing Position (A)

Review section 3

Car Seat Does Not Move More than 1" (2.5 cm) at the Belt Path (B)

Review section 3

Level Indicator's Bubble in the Blue Zone (C)

Review section 3

Harness Straps at or Just Below the Child's Shoulders (D)

Review section 5

Chest Clip Even With Armpits (E)

Review section 5

Cannot Pinch Harness Straps at the Shoulder (F). Review section 5

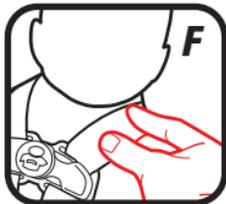
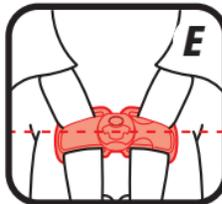

Forward-Facing

Car Seat Rotated to the Forward-Facing/Booster Position (A). Review section 4

Use the Tether Strap When Using Forward-facing (B). When used properly, the tether helps reduce injury in a sudden stop or crash.

Review section 4

Level Indicator's Bubble in the Orange Zone (C). Review section 4

Car Seat Does Not Move More than 1" (2.5 cm) at the Belt Path (D).

Review section 4

Harness Straps at or Just Above Child's Shoulders (E).

Review section 5

Chest Clip Even With Armpits (F).

Review section 5

Cannot Pinch Harness Straps at the Shoulder (G). Review section 5

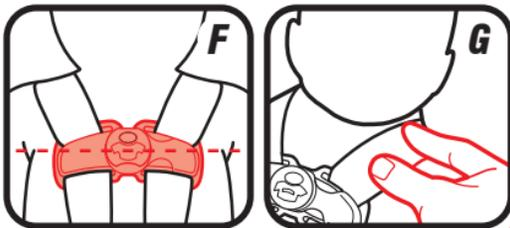
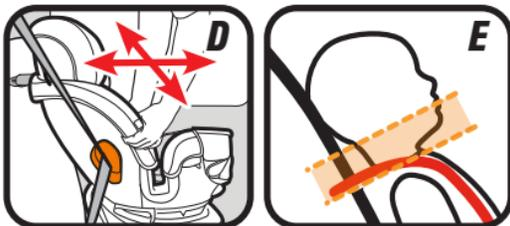
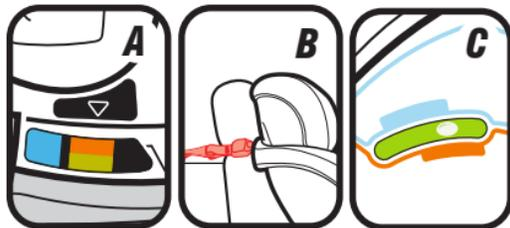

1 Important

Booster

Car Seat Rotated To The Forward-Facing/Booster Position (A)

Review section 6

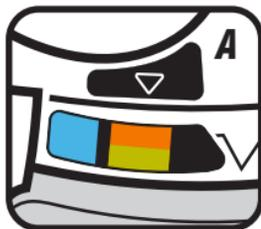

Never Use Lap Belt Only (B)

Review section 6

Lap Belt Behind Armrest and Lies Low Across Hips and Thighs (C)

Review section 6

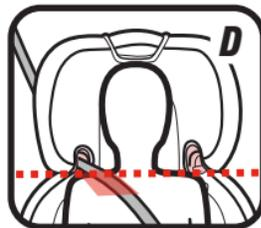
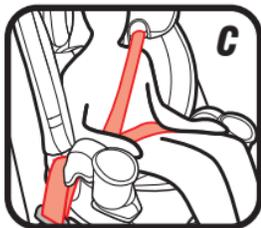

Shoulder Belt Lies On the Shoulder, Between the Neck and Edge of Shoulder (D)

Review section 6



1-B Welcome to the Graco Family!

Your child's safety depends on you. No car seat can guarantee protection from injury in every situation, but proper use helps reduce the risk of serious injury or death.

Even if this car seat seems easy to figure out on your own, you must follow the detailed instructions in this instruction manual to ensure the steps below are performed correctly.



1
Important



1 Important

1-C Right Mode of Use

4 lb
(1.8 kg)

22 lb
(10 kg)

40 lb
(18.1 kg)

65 lb
(30 kg)

100 lb
(45 kg)

Rear-Facing with 5-Point Harness

Must be 49" (125 cm) or less:
4-22 lb (1.8-10 kg) less than 1
year old **MUST** be rear-facing.
22-40 lb (10-18.1 kg) **SHOULD**
be rear-facing.*

*Check your local
and state laws and
the AAP/NHTSA
recommendations.
See page 26 for
more information.

Forward-Facing with 5-Point Harness

Must be 49" (125 cm) or less:
22-40 lb (10-18 kg) can sit upright
unassisted **CAN** be forward-facing.
40-65 lb (18.1-30 kg) **SHOULD** be
forward-facing.*

Booster Mode with Vehicle Lap/Shoulder Seat Belt

Must be 43-57" (110.1-145 cm) tall and 4+ years
old: 40-65 lb (18.1-30 kg) **CAN** be in booster mode.
Over 65 lb (30 kg) **MUST** be in booster mode.*

1-D Before You Begin

Register This Child Restraint

Please fill out the prepaid registration postcard attached to the harness and mail it in today **or register online at www.gracobaby.com/carseatregistration.**

Child restraints could be recalled for safety reasons. You must register this restraint to be reached in a recall. Send your name, address, and the restraint's model number and manufacturing date to:

Graco Children's Products, Inc.
Attn: Customer Service
P.O. Box 169, Elverson, PA 19520-9901
or call 1-800-345-4109
or register online at
www.gracobaby.com/carseatregistration

For recall information, call the U.S. Government's Vehicle Safety Hotline at 1-888-327-4236 (TTY: 1-800-424-9153), or go to <http://www.NHTSA.gov>.





1 Important

For future reference or if you change addresses, record the model name, model number, date of manufacture and purchase date of this car seat on the below. You can find this information either on the registration card if you still have it or on the date label located on the bottom of the car seat.

Model Name _____

Model Number _____

Date of Manufacture _____

Date of Purchase _____

If You Need Help

In the U.S.A, please contact our Customer Service Department with any questions you may have concerning parts, use, or maintenance. When you contact us, please have your product's model number and date of manufacture ready so that we may help you efficiently. These numbers can be found on a sticker on the bottom of your car seat.

For additional resources or to get your car seat checked by a child passenger safety technician, please visit the following web sites:

www.nhtsa.gov • www.seatcheck.org • www.safekids.org

Certification

This child restraint meets or exceeds all applicable requirements of Federal motor vehicle safety standard 213 for use in motor vehicles.



This child restraint is certified for use in aircraft only when used with the internal harness system in forward-facing mode without the lock-off. Use only on forward-facing aircraft seats. Follow the instructions for vehicle installation in section 4-C, but do not use the tether. See section 8-E for routing the aircraft lap belt over the lock-off. See section 8-D “Vehicle Seat Belts” and section 8-E “Aircraft Installation.”



This child restraint is NOT certified for use in aircraft when used in rear-facing mode, or as a booster seat because aircrafts do not have shoulder belts.

Contact the airline for their specific policies.



1 Important



1 Important

Car Seat's Useful Life

STOP using this car seat and throw it away 10 years after the date of manufacture. Look for this sticker on the bottom of the car seat.

Graco Children's Products Inc. advises against loaning or passing along a car seat unless you know the complete history of the product. We also advise against purchasing a car seat second hand.

Vehicle Seat Protection

Protect vehicle seat. Use a car seat mat, towel, or thin blanket under and behind car seat.

Warm Weather Use

Car seat parts can get very hot in the sun or warm weather. **To avoid burns, always check before putting child in car seat.**

1-E Safety Warnings

No car seat can guarantee protection from injury in every situation, but proper use helps reduce the risk of serious injury or death. **READ THIS MANUAL CAREFULLY.**

WARNING!

Failure to follow these instructions and child restraint's labels can result in child striking the vehicle's interior during a sudden stop or crash.



! NEVER PLACE THIS CHILD RESTRAINT REAR-FACING IN A VEHICLE SEATING LOCATION THAT HAS AN ACTIVE FRONT AIR BAG.

If an air bag inflates, it can hit the child and car seat with great force and cause serious injury or death to your child.



1
Important



1 Important

- ! Review your vehicle owner's manual for more information about air bags and car seat use.**
- ! If your vehicle does not have a back seat, review your vehicle owner's manual.**
- ! Children are safer riding rear-facing and should ride rear-facing as long as possible, until they reach the maximum rear-facing height or weight rating for their car seat. Then children should ride forward-facing, using the built-in harness system for as long as possible until they reach the maximum forward-facing weight or height for their car seat. At that point, children should ride in a belt-positioning booster seat. A booster is no longer needed once the vehicle seat belt fits properly, typically when they reach 4 feet 9 inches (145 cm) tall and are between ages 8-12. Be sure to check your local and state laws, as well as AAP and NHTSA recommendations, for car seat usage.***

*Graco Supports the American Academy of Pediatrics and National Highway Traffic Safety Administration's Car Seat Guidelines. Visit www.gracobaby.com/en-US/safety for information on car seat usage recommendations.



1
Important

- ! Choose the correct mode of use for the car seat depending on your child's size. Infants less than 22 lb (10 kg) MUST use this car seat rear-facing.**
- ! Select a suitable location for the car seat in your vehicle.**
- ! Secure car seat with a vehicle seat belt or lower anchor attachment that is properly routed as shown in this manual.**
- ! Vehicle seat belt system MUST hold car seat securely. Not all vehicle seat belts can be used with a car seat.**
- ! If vehicle seat belt does not hold car seat securely, read "Vehicle Seat Belts" section 8-D and your vehicle owner's manual.**
- ! Always secure car seat with lower anchor attachment or a vehicle seat belt, even when unoccupied. In a crash, an unsecured car seat can injure passengers.**



1 Important

- ! If car seat is in a crash, it must be replaced. DO NOT use it again! A crash can cause unseen damage and using it again could result in serious injury or death.**
- ! DO NOT use car seat if it is damaged or missing parts.**
- ! DO NOT use accessories or parts other than those provided by Graco. Their use could alter the performance of the car seat.**
- ! DO NOT remove LATCH system from car seat. If using vehicle seat belt to secure car seat, lower anchor connectors must be stored.**
- ! Never leave child unattended, even when sleeping. Child may become tangled in harness straps and suffocate or strangle.**
- ! Rear-facing car seat must be properly leveled:**
 - Too reclined can result in injury or ejection.**
 - Too upright can result in breathing difficulties.**



! Never attach two lower anchor connectors to one vehicle lower anchor point unless specifically allowed by the vehicle manufacturer.

- ! Do not use both the vehicle seat belt and lower anchor attachment at the same time when using the car seat with the 5-point harness.**
- ! NEVER rotate the seat while the vehicle is in motion.**
- ! DO NOT operate vehicle until child is properly secured and the car seat is locked into position**
- ! DO NOT rotate with a child in the seat unless the car seat is securely installed in the vehicle in rear-facing mode.**
- ! The car seat MUST be rotated into and securely locked in rear-facing or forward-facing position before storing.**
- ! Always return car seat to locked position after securing/removing child.**
- ! Car seat rotation lever and trigger should only be operated by an adult.**



1 Important



2-A Features

2-A Features

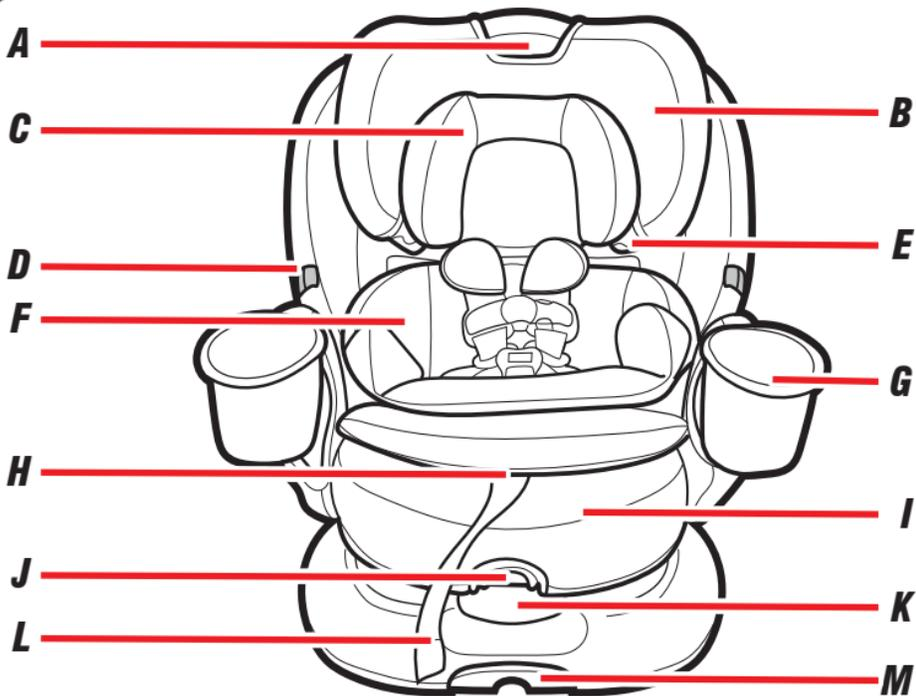

A Headrest/Harness Height Adjustment Lever

B Headrest

C Infant Head Support

D Buckle Tongue Storage

(Fuss Free Harness)

E Booster Shoulder Belt Guide

F Infant Body Support

G Cup Holder

H Harness Adjustment Lever

(under pad)

I Rear-Facing SnugLock® Lock-Off Door

J Door Release Button

K Recline Handle

L Harness Adjustment Strap

M Instruction Manual Storage



2-A
Features



2-A Features

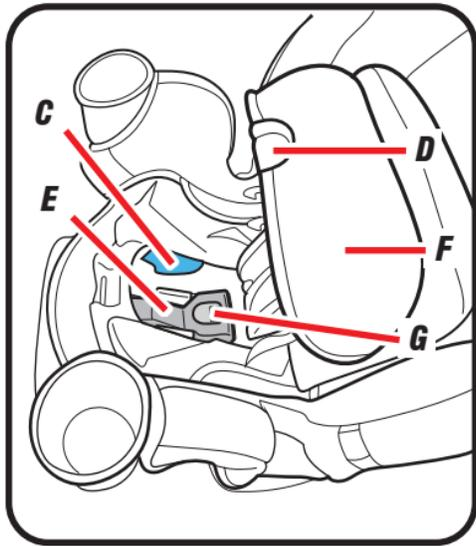
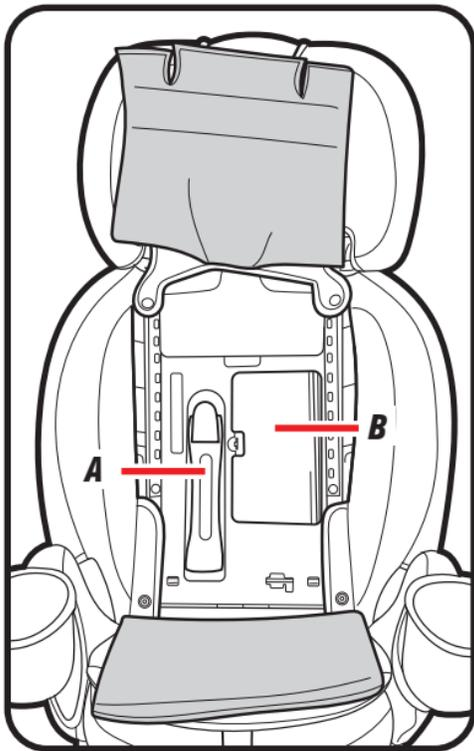

A Forward-Facing SnugLock® Lock-Off

(under seat back pad)

B Harness Storage Compartment

(under seat back pad)

C Rear-Facing Belt Path

D Door Release Button

E Rear-Facing SnugLock® Lock-Off

F Rear-Facing SnugLock® Lock-Off Door

(shown open)

**G Rear-Facing SnugLock® Lock-Off Release
Lever**

H Harness Covers

I Chest Clip

J Harness Straps

K Crotch Buckle

L Buckle Strap

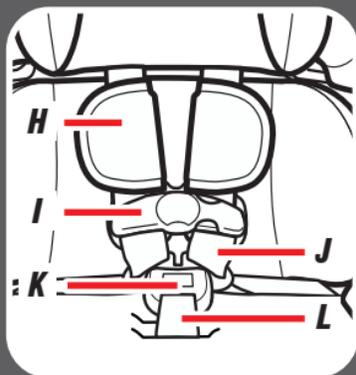

2-A
Features



2-A Features

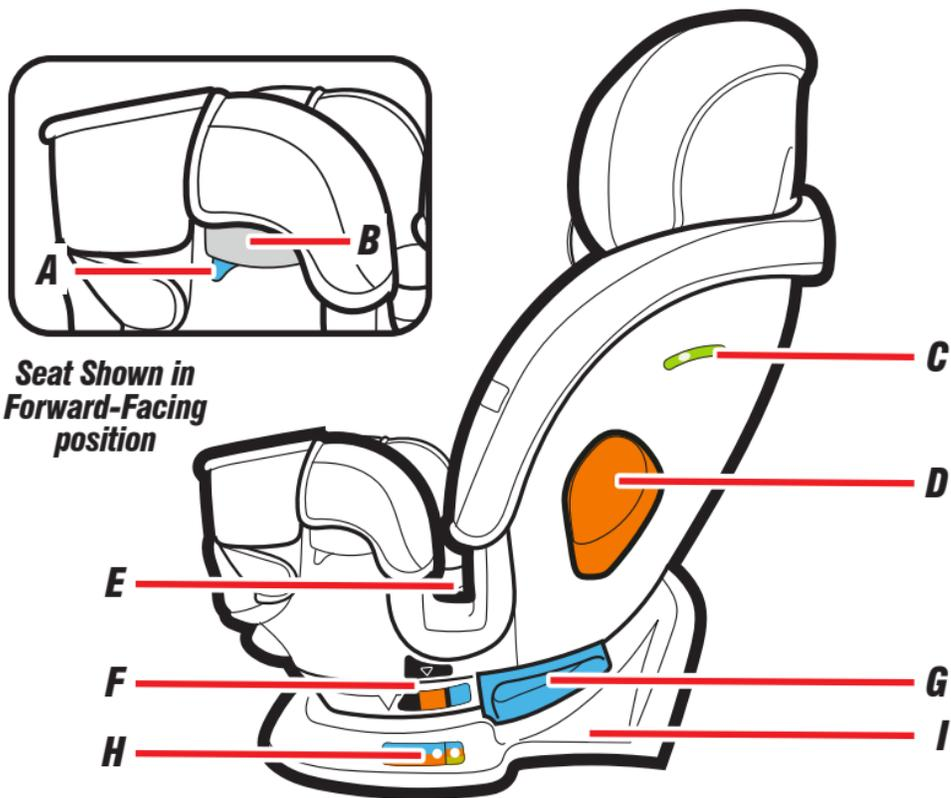

- A Car Seat Rotation Trigger***
- B Car Seat Rotation Lever***
- C Level Indicator***
- D Forward-Facing Belt Path***
- E Booster Lap Belt Path***
- F Seat Position Indicator Label***
- G Rear-Facing Belt Path***
- H Recline Position Indicator Label***
- I Seat Base***





2-A Features

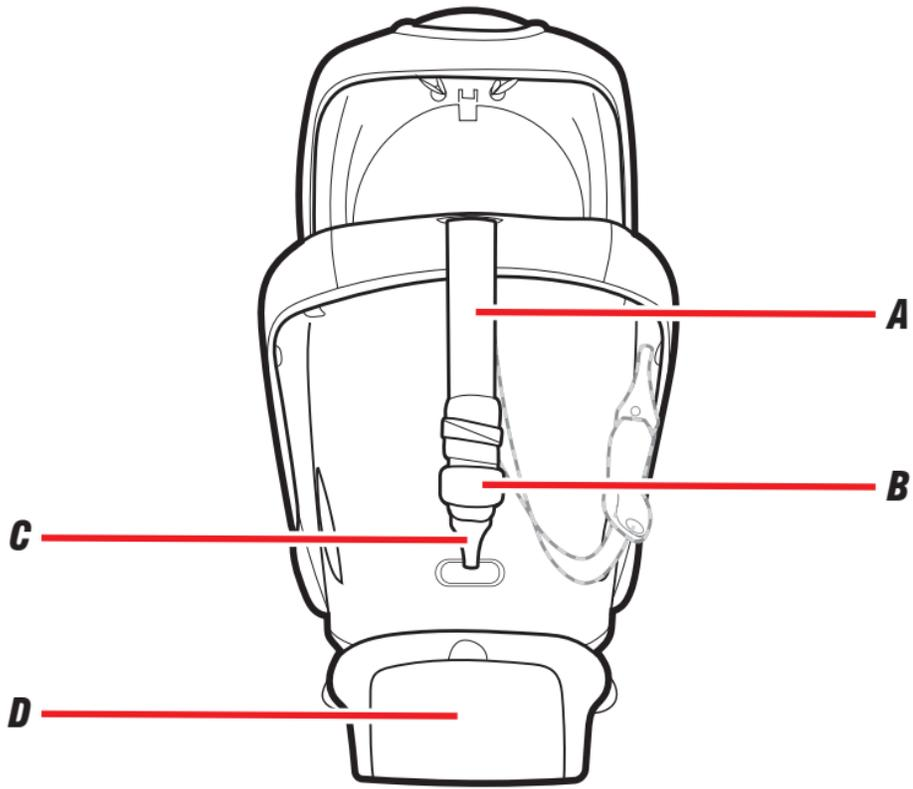



2-A Features

A Tether Strap

B Tether Strap Adjuster

C Tether Hook

D Lower Anchor Attachment Storage Compartment

E Tether Storage

F Lower Anchor Connectors
(in storage)

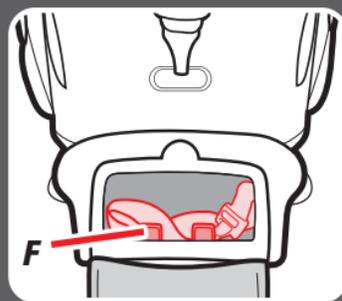



2-B Car Seat Rotation

2-B Car Seat Rotation

Rear-Facing

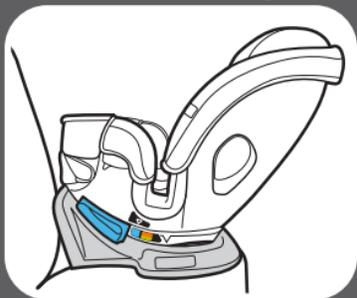

Forward-Facing

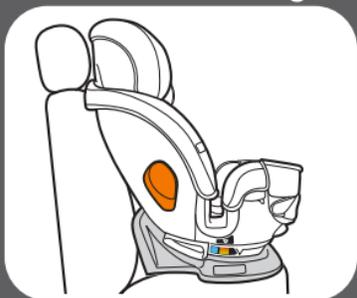

The car seat **MUST** be rotated into rear-facing position or into forward-facing position depending on the intended mode of use.

The correct position is marked with a label on the sides of the seat near the booster lap belt path. The seat is correctly in the rear-facing position when the arrow points to the blue label. The seat is correctly in the forward-facing position when the arrow points to the orange and green label.

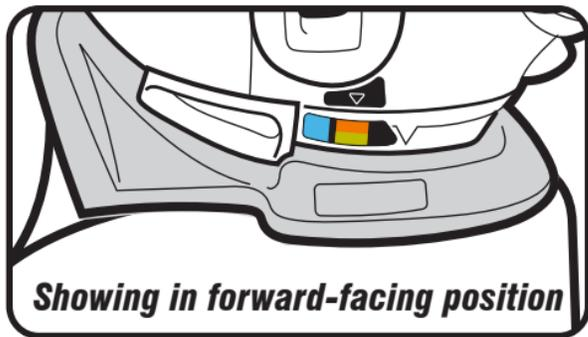

To rotate the car seat

The turn levers are located underneath each armrest. You only need to use one lever to rotate the car seat.

At the same time, slide the blue trigger and squeeze on the gray lever. Then rotate the seat to either direction to rotate the car seat.

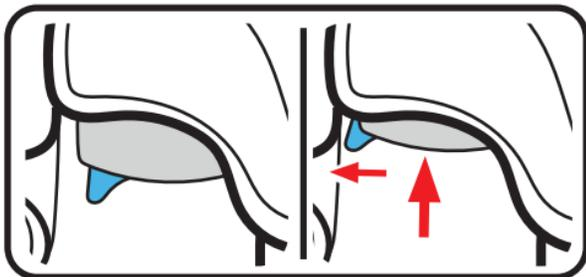

The seat is securely locked in position when you hear a “CLICK!” Grab the sides of the seat and try to rotate the seat without using the turn lever to make sure it is securely locked in place.

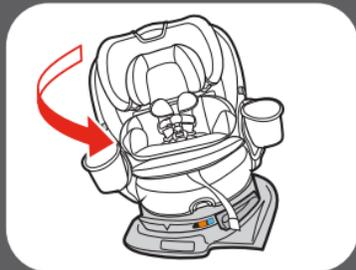
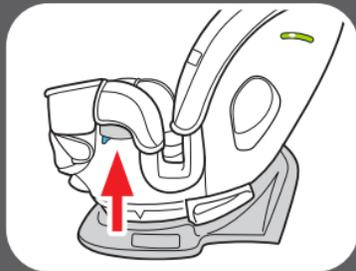

2-B
Car Seat
Rotation



2-B Car Seat Rotation

When securely installed in the vehicle in rear-facing mode the car seat can be rotated to face the door to easily secure and remove your child.

When installed in the vehicle in forward-facing mode the car seat **CANNOT** be rotated.

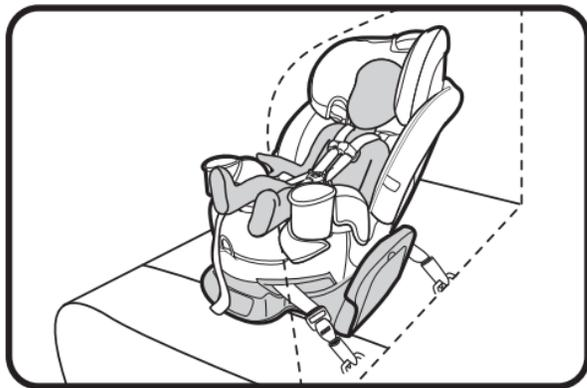

***Seat Rotated Towards
Vehicle Door***

This car seat can **ONLY** be rotated in rear-facing mode. **DO NOT** rotate the seat when securing the child in forward-facing mode.

- **NEVER** rotate the seat while the vehicle is in motion.
- Car seat rotation lever and trigger should **ONLY** be operated by an adult.
- **DO NOT** rotate with a child in the seat unless the car seat is securely installed in the vehicle in rear-facing mode.
- **DO NOT** operate vehicle until child is properly secured and the car seat is locked into position
- Always return car seat to locked position after securing/removing child.





3-A Rear-Facing Use

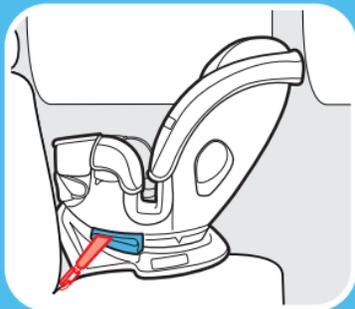

Lower Anchor Attachment

Do not install by this method for a child weighing more than 35 lb (16 kg)

Visit www.gracobaby.com and the Graco® Turn2Me™ 3-in-1 Car Seat product page to view installation videos.

Rear-Facing:
4-40 lb (1.8-18.1 kg) and whose top of head is at least 1" (2.5 cm) below the headrest adjustment handle



- ! Infants who weigh less than 22 lb (10 kg) **MUST be rear-facing.**
- ✓ Make sure the seat is in rear-facing position by checking if the Seat Position Indicator on the side of the seat is pointing to the blue label.
- ✓ Make sure the car seat is placed rear-facing in the vehicle back seat.
- ✓ Make sure lower anchor strap or vehicle seat belt is routed through the blue rear-facing belt path.
- ✓ Ensure the car seat is installed tightly in your vehicle. Car seat **should not move** at the rear-facing belt path more than 1" (2.5 cm) from side to side, front to back.
- ✓ Check recline level making sure the bubble is within the blue zone. Vehicle **MUST** be on level ground.

- ✔ Harness straps need to be **even with or just below** the top of child's shoulders and chest clip is at **armpit level**.
- ✔ Recheck the level indicator with child in seat.
- ! Children are safer riding rear-facing and should ride rear-facing as long as possible, until they reach the maximum rear-facing height or weight rating for their car seat. Then children should ride forward-facing, using the built-in harness system for as long as possible until they reach the maximum forward-facing weight or height for their car seat. Be sure to check your local and state laws, as well as AAP and NHTSA recommendations, for car seat usage.

⚠ WARNING!



NEVER place this child restraint rear-facing in a vehicle seating location that has an active front air bag.

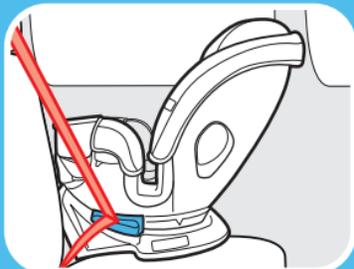

***Vehicle Seat Lap/
Shoulder Belt***

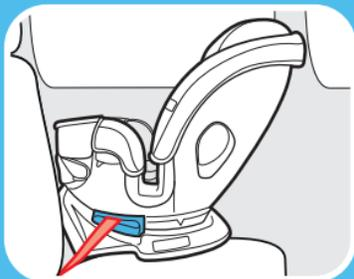

Vehicle Seat Lap Belt

Continue reading on the next page to learn how to install this car seat!



3-B
Rear Facing
with Lower Anchor
Attachment



3-B Install Rear-Facing with Lower Anchor Attachment

Review your vehicle owner's manual for lower anchor location and use. Do not install by this method for a child weighing more than 35 lb (16 kg).

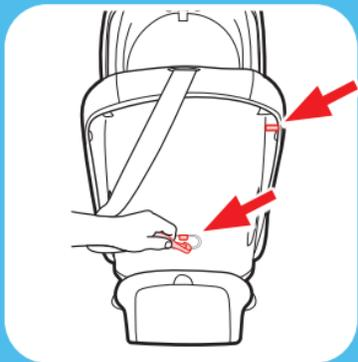

Visit www.gracobaby.com and the Graco® Turn2Me™ 3-in-1 Car Seat product page to view installation videos.

1. Store Tether Strap

Attach tether hook to the slot on the back or side of the car seat and remove the slack.

2. Rotate The Car Seat Into The Rear-Facing Position

At the same time, slide the blue trigger and squeeze the gray lever. Then rotate the seat in either direction into the rear-facing position. The seat is correctly in the rear-facing position when the arrow points to the blue label.



The seat is securely locked in position when you hear a “CLICK!” Grab the sides of the seat and try to rotate the seat without using the turn lever to make sure it is securely locked in place.



3-B
Rear Facing
Attachment
with Lower Anchor

3-B
Rear Facing
with Lower Anchor
Attachment

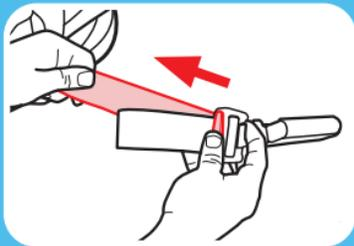

3. Remove Lower Anchor Attachment from Storage Location

Open the lower anchor storage door on the base of the car seat and remove the lower anchor attachment from the storage compartment. Close the storage compartment door.

4. Extend the Lower Anchor Strap

For easier installation, extend the lower anchor strap to its maximum length by pressing the grey button and pulling on the strap.

5. Lay the Lower Anchor Attachment Connectors in the Seat

The strap may not be long enough for both connectors to reach the seat. Simply lay the loose end of the strap in the seat, as shown.



6. Recline the Car Seat

From the rear of the seat, pull the recline handle and place the car seat in any of the 4 recline positions.

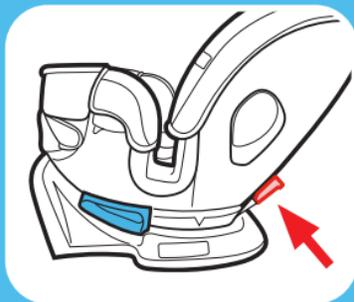
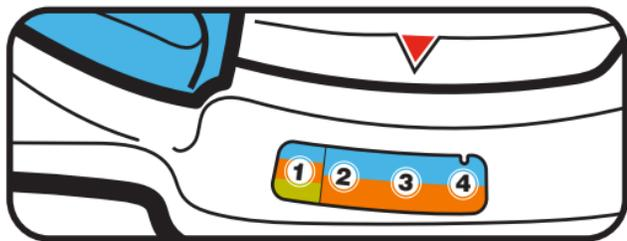

3-B
Rear Facing
with Lower Anchor
Attachment

3-B
Rear Facing
with Lower Anchor
Attachment

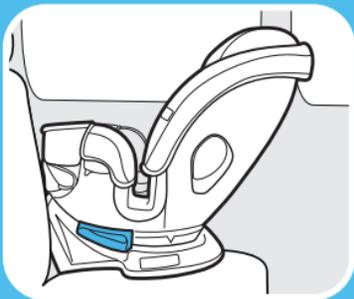

7. Place Car Seat Rear-Facing in Back Seat of the Vehicle

Place rear-facing in vehicle seat and center the car seat between the lower anchors. The base should sit as flat as possible on the vehicle seat.

Slide the seat until it touches the vehicle seat back.

8. Make Sure Base is a minimum of 80% on Vehicle Seat

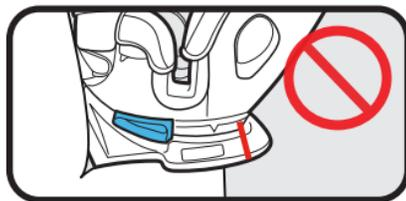

9. Check the Level Indicator

Vehicle **MUST** be on level ground.

Check the level indicator on the car seat.
The **bubble must be completely within** the blue zone.

Adjust the recline until the bubble is completely within the blue zone.

If needed, rolled towels may be placed under the car seat at the vehicle seat crease, until the ball is completely in the blue zone.

10. Remove the Infant Body Support

Remove the infant body support if it is installed in the seat. You may reinstall the body support once the car seat is fully secured.

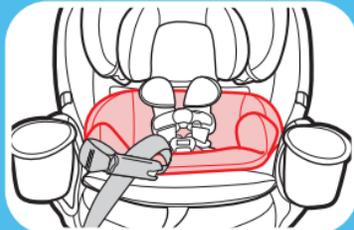
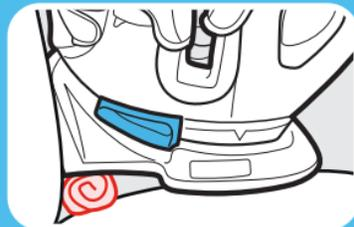

3-B

Rear Facing
with Lower Anchor
Attachment

3-B
Rear Facing
with Lower Anchor
Attachment

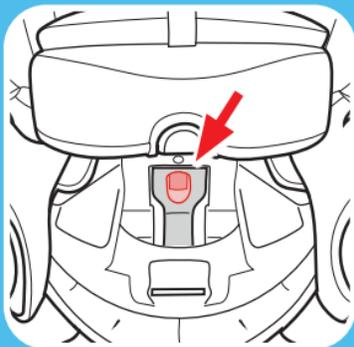

11. Open The Door To Expose The Rear-Facing Belt Path

Press the button on the front of the car seat and lift up to open the door and expose the rear-facing belt path.

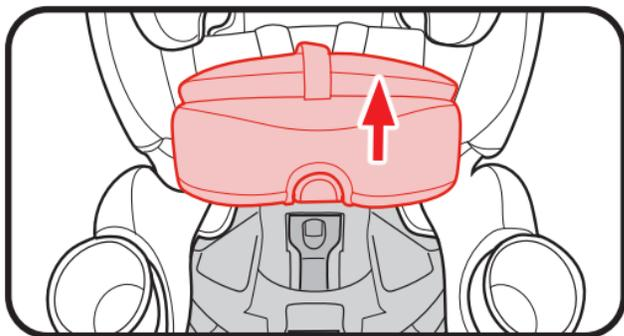

12. Open the SnugLock® Lock-Off

Pull the grey lever to open the SnugLock® lock-off.

13. *Route the Lower Anchor Strap*

Thread the lower anchor strap through the blue rear-facing belt path, under the SnugLock® lock-off and out the other side. The strap should lie as flat as possible and not be twisted.

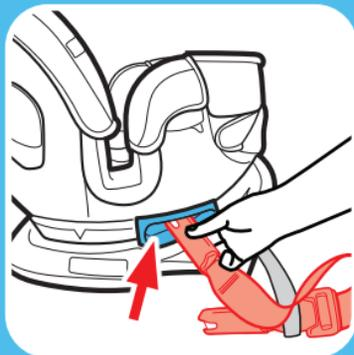
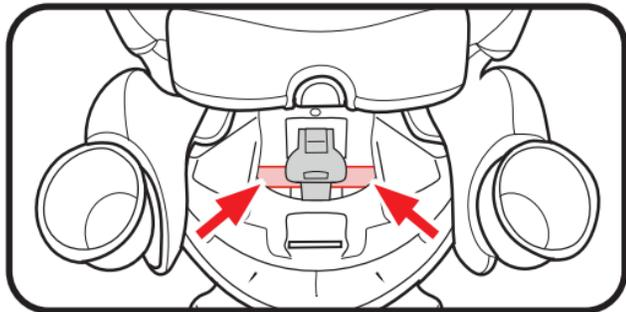

3-B

**Rear Facing
with Lower Anchor
Attachment**

3-B Rear Facing with Lower Anchor Attachment

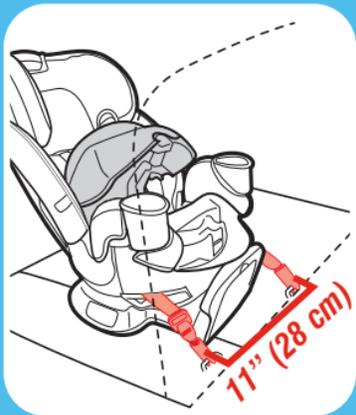

14. Attach Lower Anchor Connectors to Vehicle's Lower Anchors

Make sure the arrows are pointing up.

Lower anchor strap should not be twisted. If twisted, you will not be able to tighten the strap.

Lower anchor attachment can only be used if the vehicle lower anchor spacing is 11" (28 cm) from the center of one lower anchor to the center of the other lower anchor.

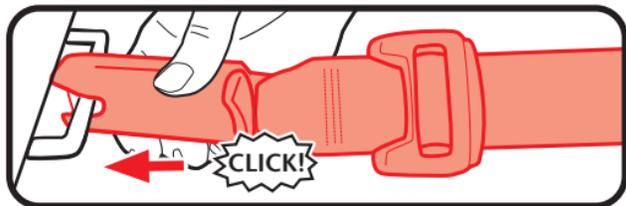
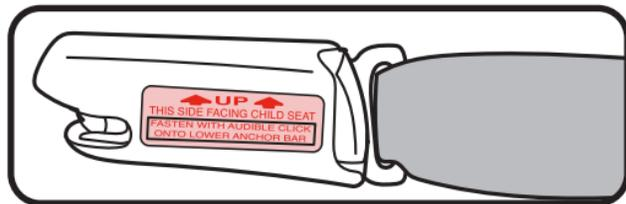

15. Tighten the Lower Anchor Strap

Press down firmly in the center of the car seat while tightening the lower anchor strap. You may need to tighten through the belt path as shown.

Do not pull on the belt with excessive force. If the belt is too tight, you will not be able to close the SnugLock® Lock-Off.

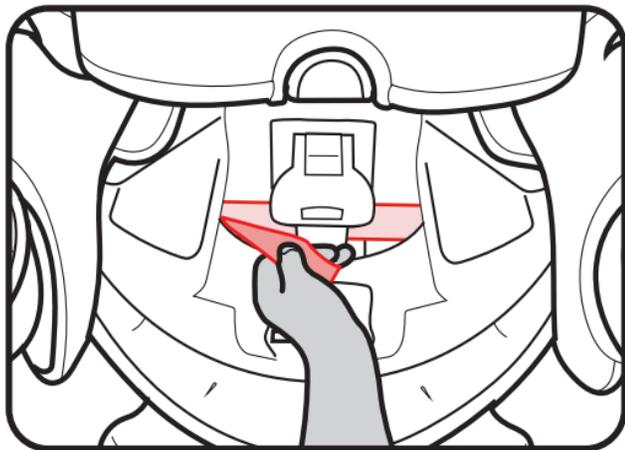

3-B

Rear Facing
with Lower Anchor
Attachment

3-B
Rear Facing
with Lower Anchor
Attachment

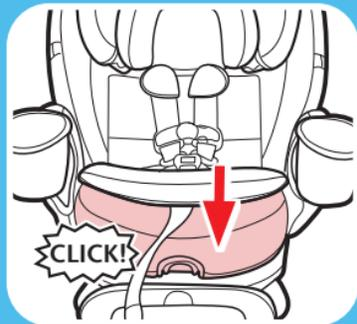
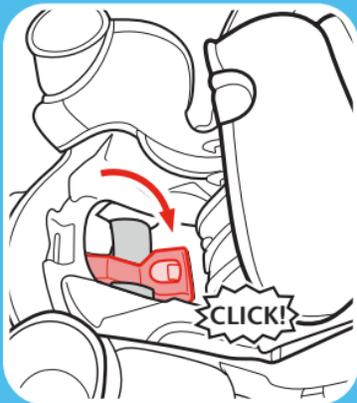

16. Close the SnugLock® Lock-Off

When the slack is removed, close the SnugLock® Lock-Off until you hear a “CLICK!”. Make sure the Lower Anchor strap is under the SnugLock® Lock-Off.

! WARNING!

Keep hands away from the lock-off area when closing the lock-off.

17. Close the Door

Lower the door back down. The door is secure when you hear a “CLICK!”.

18. Test For Tightness

Grab the sides of the seat where the lower anchor strap is and slide the car seat side-to-side and front-to-back.

If the seat moves less than 1" (2.5 cm), it is tight enough.

19. Check the Level Indicator

Vehicle **MUST** be on level ground.

Check the level indicator on the car seat. The **bubble must be completely within** the blue zone. Readjust if needed.

See section 5-A to secure your child.

Recheck the level indicator with child in seat.

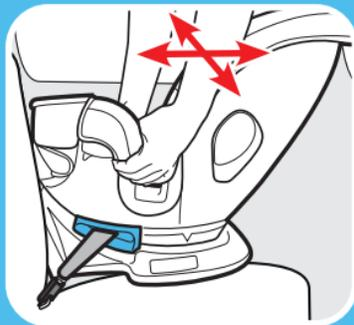

3-B

Rear Facing
with Lower Anchor
Attachment

3-B
Rear Facing
with Lower Anchor
Attachment



Is Everything Correct?

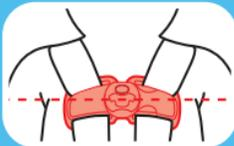
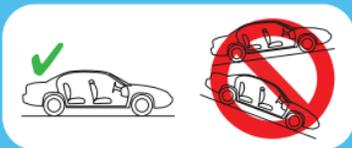

Car Seat Rotated to the Rear-Facing Position and Car Seat Does Not Move More than 1" (2.5 cm) at the Belt Path

Level Indicator's Bubble in the Blue Zone and Vehicle on Level Ground



Harness Straps at or Just Below the Child's Shoulders

Review section 5

Chest Clip Even With Armpits

Review section 5

Cannot Pinch Harness Straps at the Shoulder

Review section 5

3-C Install Rear-Facing with Vehicle Seat Belt

1. Store Tether and Lower Anchor Connectors in Storage Locations

Attach tether hook to the slot on the back or side of the car seat and remove the slack.

Store the lower anchor connectors in the storage compartment in the seat base.

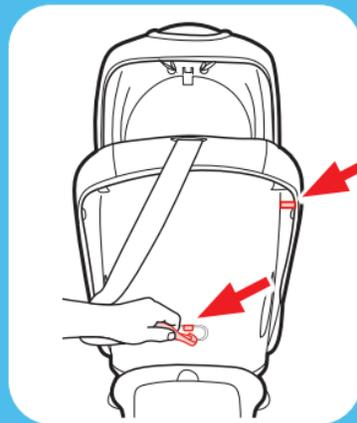
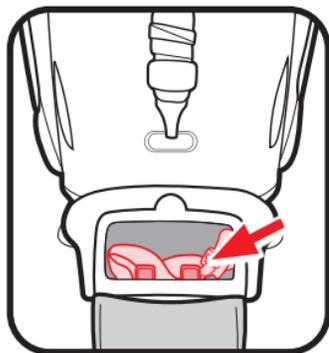

Visit www.gracobaby.com and the Graco® Turn2Me™ 3-in-1 Car Seat product page to view installation videos.



3-C Rear Facing with Seat Belt

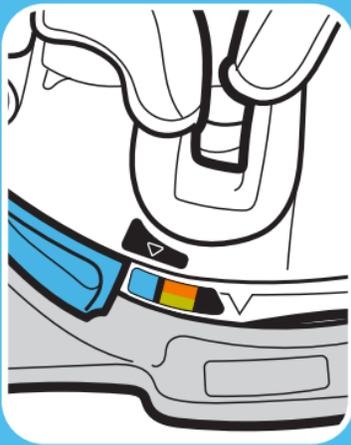

2. Rotate The Car Seat Into The Rear-Facing Position

At the same time, slide the blue trigger and squeeze the gray lever. Then rotate the seat in either direction into the rear-facing position. The seat is correctly in the rear-facing position when the arrow points to the blue label.

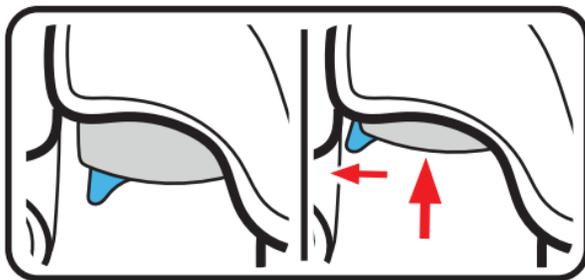

The seat is securely locked in position when you hear a “CLICK!” Grab the sides of the seat and try to rotate the seat without using the turn lever to make sure it is securely locked in place.

3. Recline the Car Seat

From the rear of the seat, pull the recline handle and place the car seat in any of the 4 recline positions.

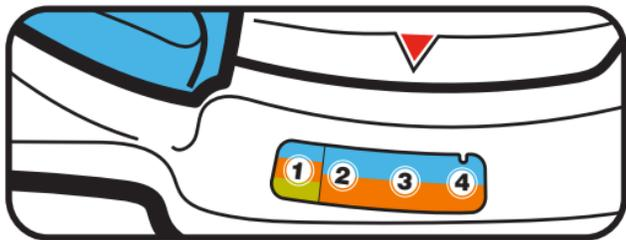

4. Place Car Seat Rear-Facing in Back Seat of the Vehicle

Place rear-facing in vehicle seat. The base should sit as flat as possible on the vehicle seat.

Slide the seat until it touches the vehicle seat back.

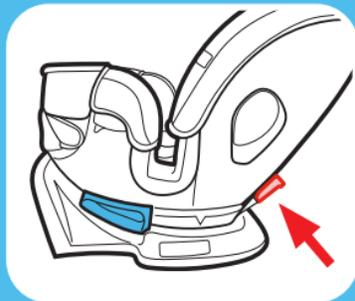

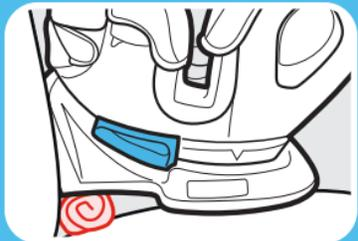
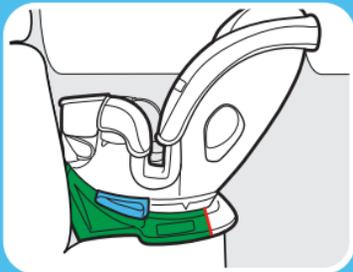

3-C Rear Facing
with Seat Belt

3-C Rear Facing with Seat Belt

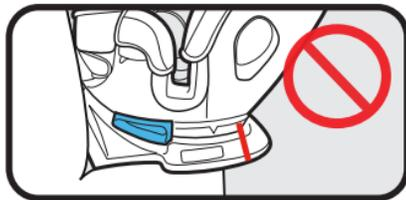

5. **Make Sure Base is a minimum of 80% on Vehicle Seat**



6. **Check the Level Indicator**

Vehicle **MUST** be on level ground.

Check the level indicator on the car seat. The **bubble must be completely within** the blue zone.

Adjust the recline until the bubble is completely within the blue zone.

If needed, rolled towels may be placed under the car seat at the vehicle seat crease, until the ball is completely in the blue zone.

7. Remove the Infant Body Support

Remove the infant body support if it is installed in the seat. You may reinstall the body support once the car seat is fully secured.

8. Open The Door To Expose The Rear-Facing Belt Path

Press the button on the front of the car seat and lift up to open the door and expose the rear-facing belt path.

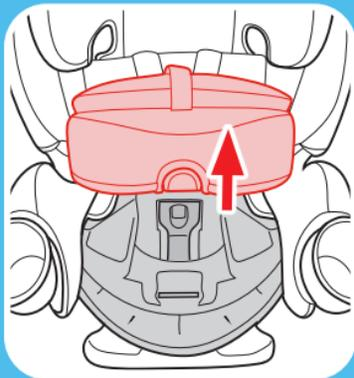
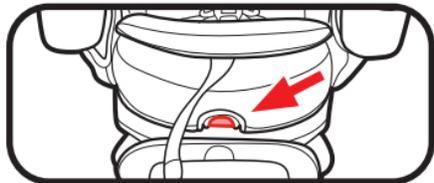

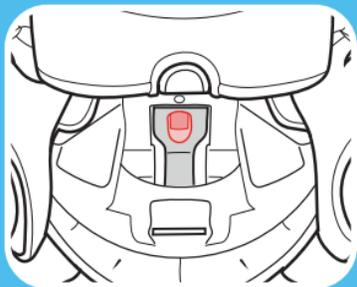

3-C Rear Facing
with Seat Belt

3-C Rear Facing with Seat Belt

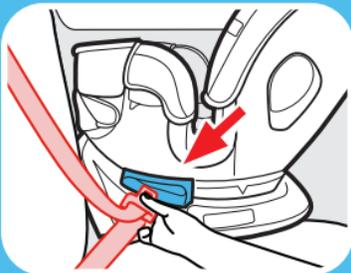

Review your vehicle owner's manual for vehicle seat belt use



9. Open the SnugLock® Lock-Off

Pull the grey lever to open the SnugLock® lock-off.

10. Route the Vehicle Seat Belt

Thread vehicle seat belt through the blue rear-facing belt path, under the SnugLock® lock-off and out the other side. Buckle the seat belt. The seat belt should lie as flat as possible and not be twisted.

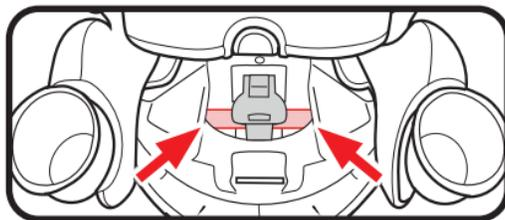

11. Tighten the Vehicle Seat Belt

Press down firmly in the center of the car seat. Pull on the shoulder belt to tighten while feeding the slack back in the retractor.

DO NOT pull on the belt with excessive force. If the belt is too tight, you will not be able to close the SnugLock® Lock-Off.

12. Close the SnugLock® Lock-Off

When the slack is removed, close the SnugLock® Lock-Off until you hear a “CLICK!”. Make sure the vehicle seat belt is under the SnugLock® Lock-Off.

13. Switch the Retractor

Switch the retractor after the installation is complete to avoid a possible strangulation risk.

⚠ WARNING!

Keep hands away from the lock-off area when closing the lock-off.

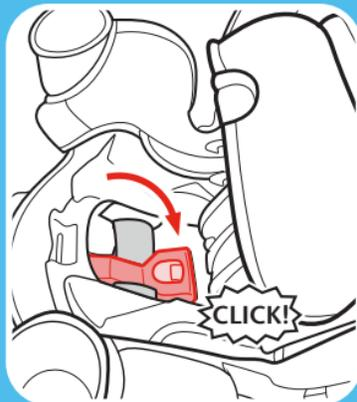

3-C Rear Facing
with Seat Belt



3-C Rear Facing with Seat Belt

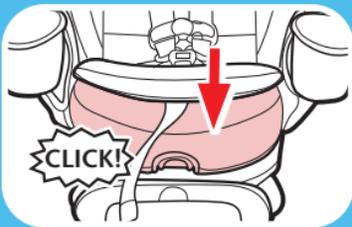

14. Close the door

Lower the door back down. The door is secure when you hear a “CLICK!”.

15. Test For Tightness

Grab the sides of the seat where the vehicle seat belt is and slide the car seat side-to-side and front-to-back.

If the seat moves less than 1” (2.5 cm), it is tight enough.

16. Check the Level Indicator

Vehicle **MUST** be on level ground.

Check the level indicator on the car seat. The **bubble must be completely within** the blue zone. Readjust if needed.

See section 5-A to secure your child.

Recheck the level indicator with child in seat.

Is Everything Correct?

Car Seat Rotated to the Rear-Facing Position and Car Seat Does Not Move More than 1" (2.5 cm) at the Belt Path

Level Indicator's Bubble in the Blue Zone and Vehicle on Level Ground



Harness Straps at or Just Below the Child's Shoulders

Review section 5

Chest Clip Even With Armpits

Review section 5

Cannot Pinch Harness Straps at the Shoulder

Review section 5

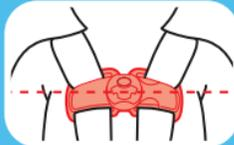
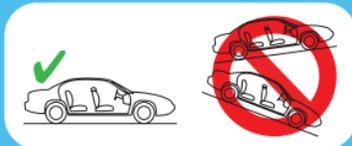

3-C Rear Facing
with Seat Belt



4-A Forward-Facing

4-A Forward-Facing Use



LATCH

Do not install by this method for a child weighing more than 40 lb (18 kg)

Visit www.gracobaby.com and the Graco® Turn2Me™ 3-in-1 Car Seat product page to view installation videos.

**Forward-Facing:
22-65 lb (10-30 kg)
49" (125 cm) or less**

- ✓ Make sure the seat is in forward-facing position by checking if the Seat Position Indicator on the side of the seat is pointing to the orange and green label.
- ✓ Make sure the car seat is placed forward-facing in the vehicle back seat.
- ✓ Make sure lower anchor strap or vehicle seat belt is routed through the orange forward-facing belt path.
- ✓ Ensure this car seat is installed tightly in your vehicle. Car seat **should not move** at the forward-facing belt path more than 1" (2.5 cm) from side to side, front to back.
- ✓ Harness straps need to be **even with or just above** the top of child's shoulders and chest clip is at **arm-pit level**.



- ✔ Check recline level making sure the bubble is within the orange zone. Vehicle **MUST** be on level ground.
- ! DO NOT rotate the car seat when securing the child in forward-facing mode.
- ! If the seat is already installed in Rear-Facing mode, you will need to completely uninstall the seat to rotate the seat into Forward-Facing mode.
- ! Children are safer riding rear-facing and should ride rear-facing as long as possible, until they reach the maximum rear-facing height or weight rating for their car seat. Then children should ride forward-facing, using the built-in harness system for as long as possible until they reach the maximum forward-facing weight or height for their car seat. At that point, children should ride in a belt-positioning booster seat. Be sure to check your local and state laws, as well as AAP and NHTSA recommendations, for car seat usage.



Vehicle Lap/Shoulder Belt with Tether

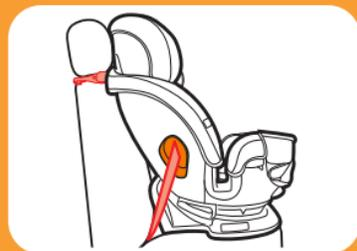

Vehicle Seat Lap Belt with Tether

Continue reading on the next page to learn how to install this car seat!



4-B Install Forward-Facing with LATCH

Review your vehicle owner's manual for LATCH location and use. Do not install by this method for a child weighing more than 40 lb (18 kg).

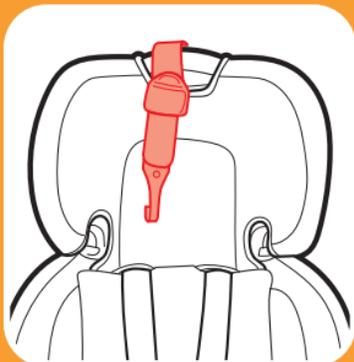

Visit www.gracobaby.com
and the Graco® Turn2Me™
3-in-1 Car Seat product
page to view installation
videos.

1. Unhook Tether Strap From Storage

Unhook tether and lay it in the seat.

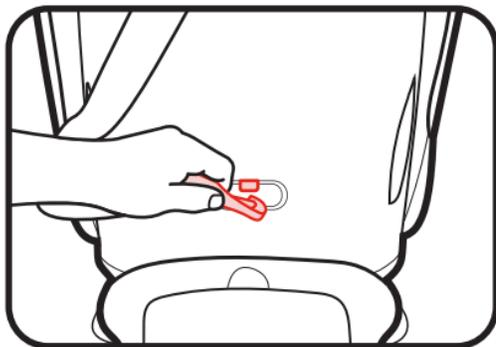

2. Rotate The Car Seat Into The Forward-Facing Position

At the same time, slide the blue trigger and squeeze the gray lever. Then rotate the seat in either direction into the forward-facing position. The seat is correctly in the forward-facing position when the arrow points to the orange and green label. The seat is secure when it “clicks” into place.

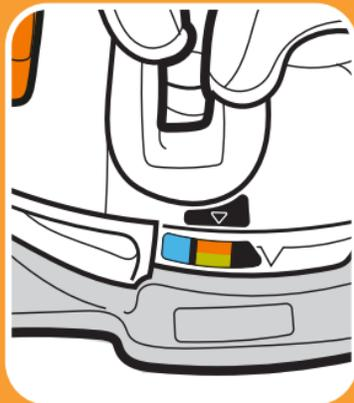
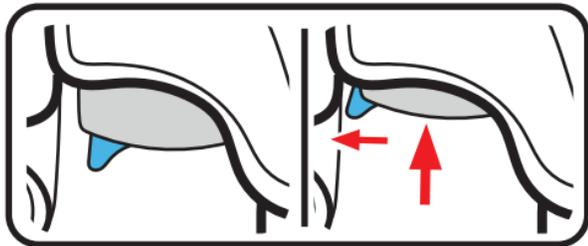

4-B Forward-Facing
with LATCH

Forward-Facing
with LATCH

4-B

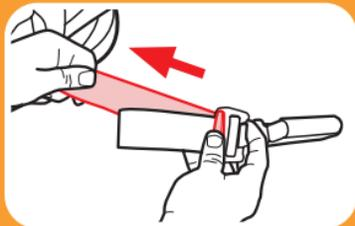

3. Remove Lower Anchor Attachment from Storage Location

Open the lower anchor storage door on the base of the car seat and remove the lower anchor attachment from the storage compartment. Close the storage compartment door.

4. Extend the Lower Anchor Strap

For easier installation, extend the lower anchor strap to its maximum length by pressing the grey button and pull out on the strap.

5. Route the Lower Anchor Strap

Thread the lower anchor strap through the orange forward-facing belt path and out the other side. The strap should lie as flat as possible and not be twisted.

6. Recline the Car Seat

Place the car seat in any of the 4 recline positions.

For children under 25 lb (11.3 kg), you MUST use recline positions 2 or 3.

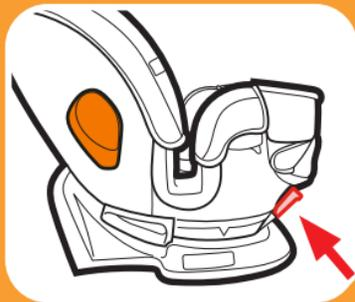
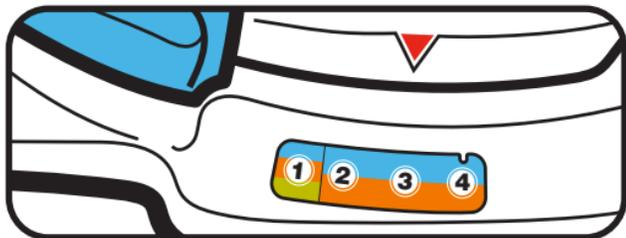

Forward-Facing
with LATCH
4-B



7. Place Car Seat Forward-Facing in Back Seat of the Vehicle

Place forward-facing in vehicle seat and center the car seat between the lower anchors. The base should sit as flat as possible on the vehicle seat. Slide the seat until it touches the vehicle seat back.

8. Make Sure Base is a minimum of 80% on Vehicle Seat.



9. Check the Level Indicator

Vehicle **MUST** be on level ground.

Check the level indicator on the car seat. The **bubble must be completely within** the orange zone.

Adjust the recline until the bubble is completely within the orange zone.

If needed, rolled towels may be placed under the car seat at the vehicle seat crease, until the ball is completely in the orange zone.



4-B Forward-Facing
with LATCH

4-B Forward-Facing
with LATCH

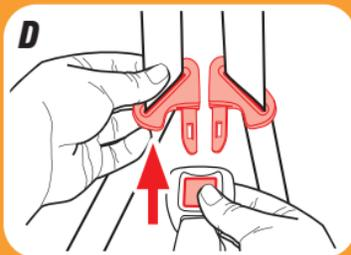
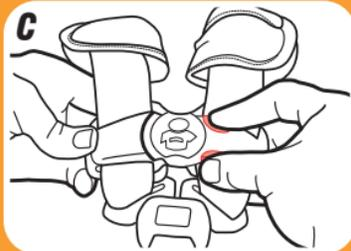

10. Expose the Lock-Off

- A.** Loosen the harness straps.
- B.** Raise the headrest to the highest position.
- C.** Unbuckle the chest clip.
- D.** Unbuckle the buckle.

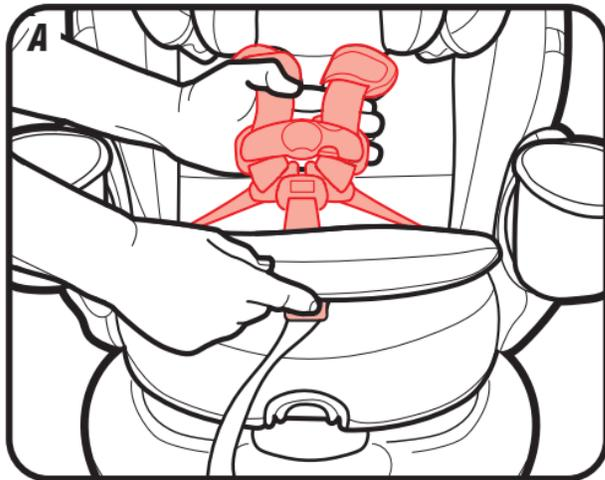

E. Lift the headrest pad flap up out of the way.

F. Undo the 2 lower snaps.

11. Open the SnugLock® Lock-Off

Pull the gray lever to open the SnugLock® lock-off.

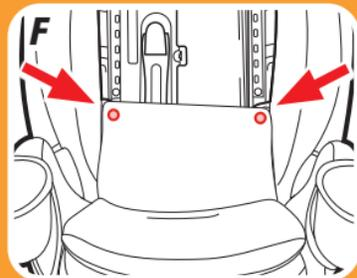
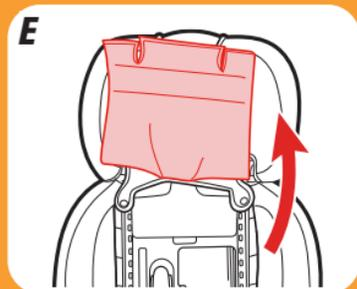

4-B
Forward-Facing
with LATCH

Forward-Facing
with LATCH

4-B

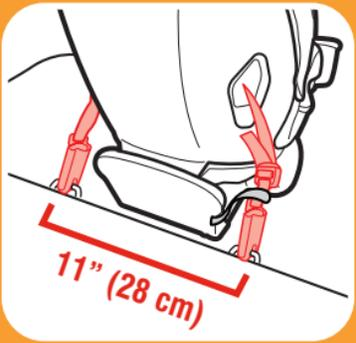
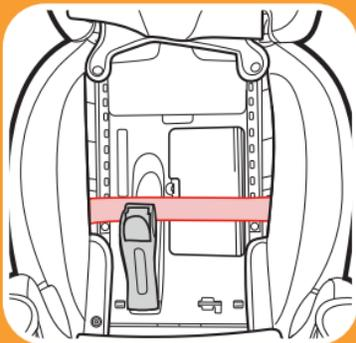

12. Route the Lower Anchor Strap Under the SnugLock® Lock-Off

The lower anchor strap should lie as flat as possible and not be twisted.

13. Connect the Lower Anchor Connectors to Vehicle's Lower Anchors

Lower anchor strap should not be twisted. If twisted, you will not be able to tighten the strap.



Make sure the arrows are pointing up.



Lower anchor connectors can only be used if the vehicle lower anchor spacing is 11 inches (28 cm) from the center of one lower anchor to the center of the other lower anchor.

14. ***Tighten the Lower Anchor Strap***

Press down firmly in the center of the car seat while tightening the lower anchor strap. You may need to tighten through the belt path as shown. **Do not pull on the belt with excessive force. If the belt is too tight, you will not be able to close the SnugLock® Lock-Off.**

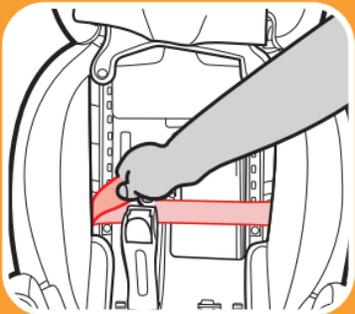

4-B Forward-Facing
with LATCH

4-B Forward-Facing
with LATCH

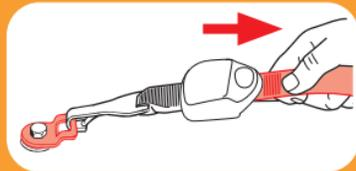
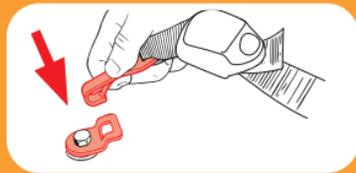
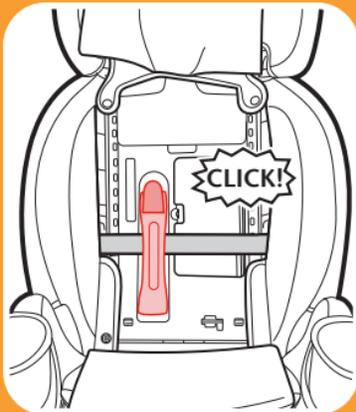

15. Close the SnugLock® Lock-Off

When the slack is removed, close the SnugLock® Lock-Off until you hear a “CLICK!”. Make sure the Lower Anchor strap is under the SnugLock® Lock-Off.

! WARNING!

Keep hands away from the lock-off area when closing the lock-off.

16. Attach Tether Strap

Extend the tether by lifting up on the tether adjuster and attach.

Consult vehicle owner’s manual for specific location.

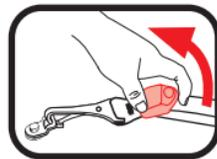

17. Tighten Tether Strap

Remove all the slack.

18. **Test For Tightness**

Grab the sides of the seat where the lower anchor strap is and slide the car seat side-to-side and front-to-back.

If the seat moves less than 1" (2.5 cm), it is tight enough.

See section 5-A to secure your child.

19. **Replace the Seat Pad**

Move the headrest back to its proper position for your child.

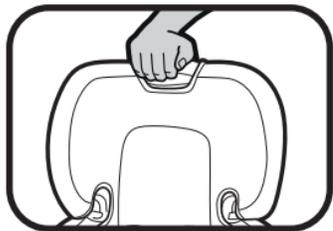

4-B Forward-Facing
with LATCH



**Forward-Facing
4-B
with LATCH**

Is Everything Correct?

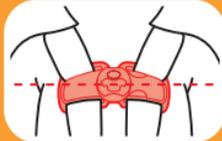
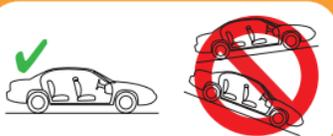

Car Seat Rotated to the Forward-Facing Position and Car Seat Does Not Move More than 1" (2.5 cm) at the Belt Path

Level Indicator's Bubble in the Orange Zone and Vehicle on Level Ground



Harness Straps at or Just Above the Child's Shoulders

Review section 5

Chest Clip Even With Armpits

Review section 5

Cannot Pinch Harness Straps at the Shoulder

Review section 5

4-C Install Forward-Facing with Vehicle Seat Belt

Visit www.gracobaby.com and the Graco® Turn2Me™ 3-in-1 Car Seat product page to view installation videos.

1. Store Lower Anchor Connectors in Storage Location

Store the lower anchor connectors in the storage compartment in the seat base.

2. Unhook Tether Strap From Storage

Unhook tether and lay it in the seat.

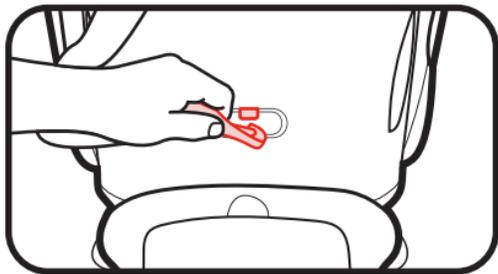

81

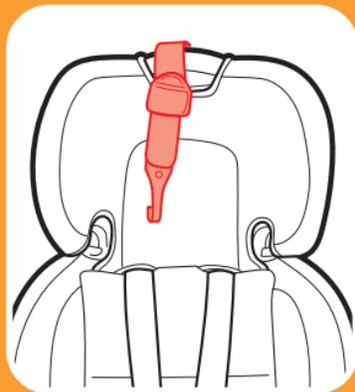

4-C Forward-Facing
with Seat Belt



4-C Forward-Facing with Seat Belt

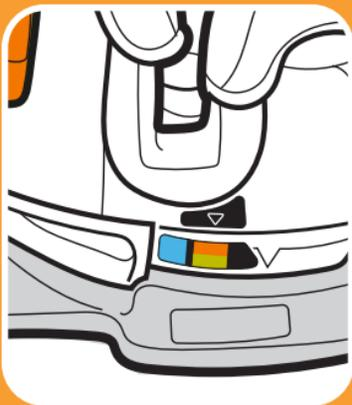

3. *Rotate the car seat into the forward-facing position*

At the same time, slide the blue trigger and squeeze the gray lever. Then rotate the seat in either direction into the forward-facing position. The seat is correctly in the forward-facing position when the arrow points to the orange and green label. The seat is secure when it “clicks” into place.

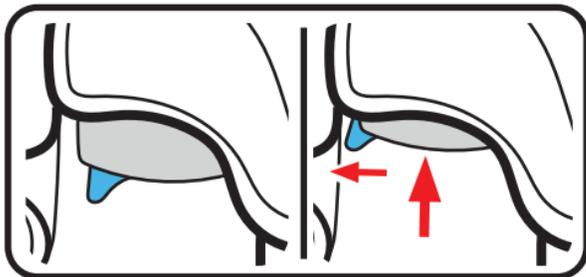

4. Recline the Car Seat

Place the car seat in any of the 4 recline positions. For children under 25 lb (11.3 kg), you **MUST** use recline positions 2 or 3.

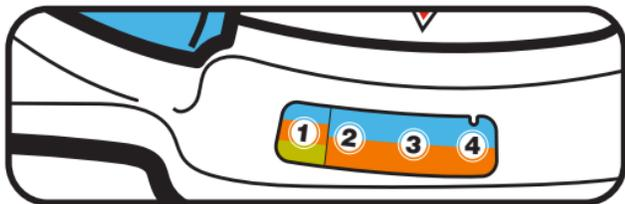

5. Place Car Seat Forward-Facing in Back Seat of the Vehicle

Place forward-facing in vehicle seat. The base should sit as flat as possible on the vehicle seat.

Slide the seat until it touches the vehicle seat back.

6. Make Sure Base is a minimum of 80% on Vehicle Seat

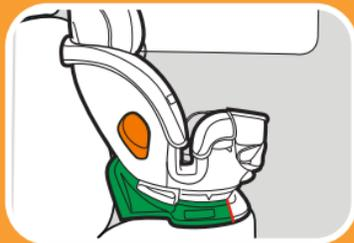
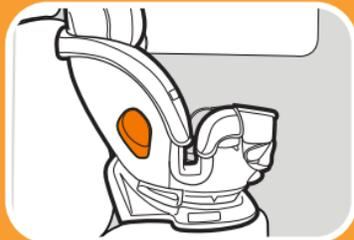
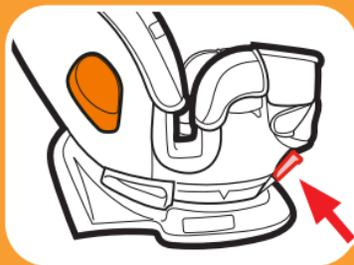

4-C Forward-Facing
with Seat Belt



Forward-Facing
with Seat Belt

4-C

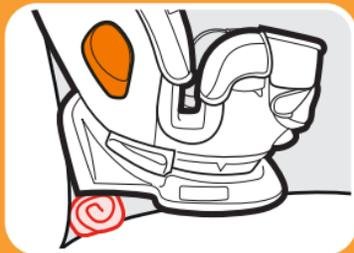

7. Check the Level Indicator

Vehicle **MUST** be on level ground.

Check the level indicator on the car seat. The **bubble must be completely within** the orange zone.

Adjust the recline until the bubble is completely within the orange zone.

If needed, rolled towels may be placed under the car seat at the vehicle seat crease, until the ball is completely in the orange zone.

8. Expose the SnugLock® Lock-Off

- A. Loosen the harness straps.
- B. Raise the headrest to the highest position.
- C. Unbuckle the chest clip.
- D. Unbuckle the buckle.

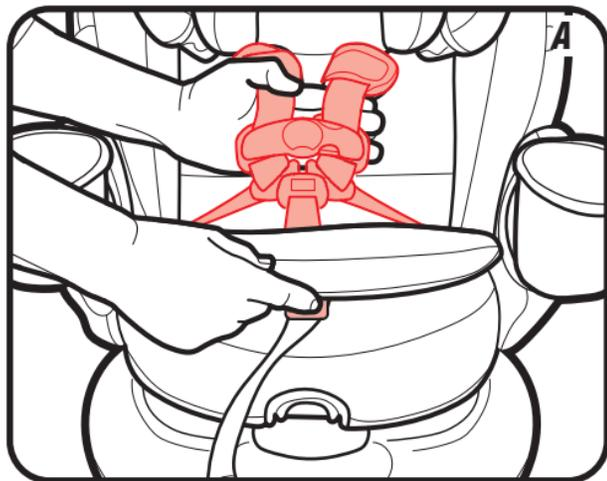

85

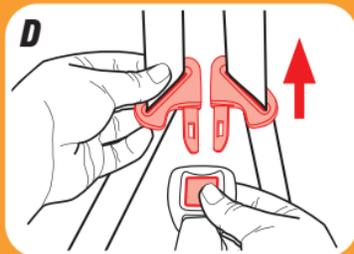
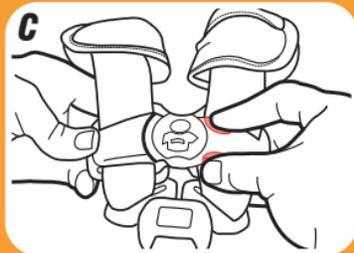

4-C Forward-Facing
with Seat Belt



4-C Forward-Facing with Seat Belt

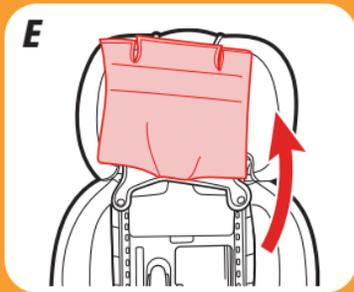

E. Lift the headrest pad flap up out of the way.

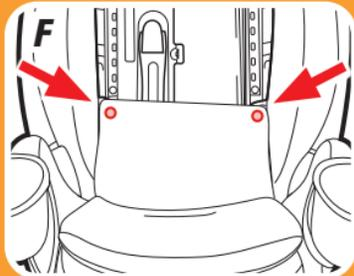

F. Undo the 2 lower snaps.

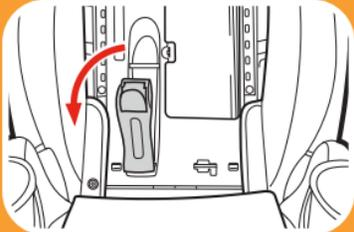

9. Open the SnugLock® Lock-Off

Pull the lever to open the SnugLock® lock-off.

Review your vehicle owner's manual for vehicle seat belt use



4-C Forward-Facing with Seat Belt

10. Route the Vehicle Seat Belt

Thread vehicle seat belt through the orange forward-facing belt path, through the lock-off, and out the other side. Buckle the seat belt. The seat belt should lie as flat as possible and not be twisted.

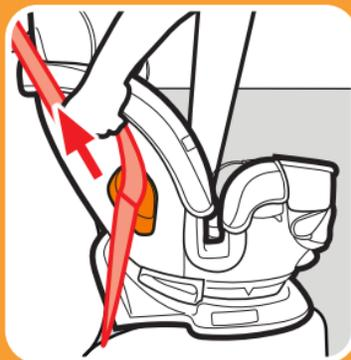
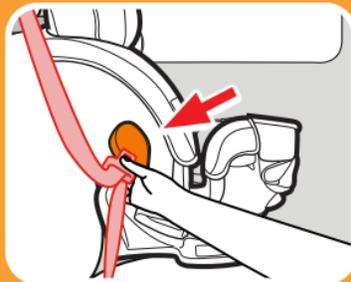
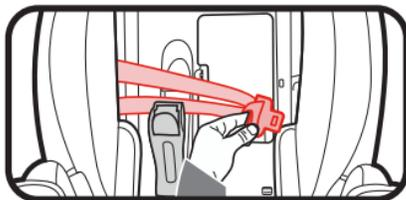

11. Tighten the Vehicle Seat Belt

Press down firmly in the center of the car seat. Pull on the shoulder belt to tighten while feeding the slack back in the retractor.

DO NOT pull on the belt with excessive force. If the belt is too tight, you will not be able to close the SnugLock® Lock-Off.



4-C Forward-Facing with Seat Belt

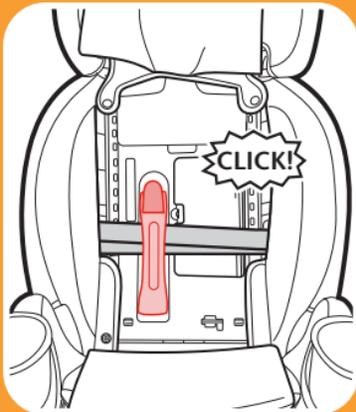

12. Close the SnugLock® Lock-Off

When the slack is removed, close the SnugLock® Lock-Off until you hear a “CLICK!”. Make sure the vehicle seat belt is under the SnugLock® Lock-Off.

13. Switch the Retractor

Switch the retractor after the installation is complete to avoid a possible strangulation risk.

! WARNING!

Keep hands away from the lock-off area when closing the lock-off.

14. **Attach Tether Strap**

Extend the tether by lifting up on the tether adjuster and attach.

Consult vehicle owner's manual for specific location.

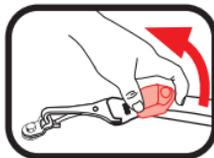

15. **Tighten Tether Strap**

Remove all the slack.

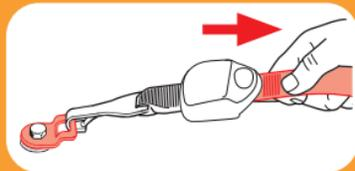
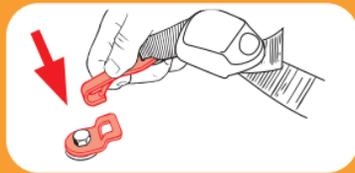

16. **Test For Tightness**

Grab the sides of the seat where the lower anchor strap is and slide the car seat side-to-side and front-to-back.

If the seat moves less than 1" (2.5 cm), it is tight enough.

See section 5-A to secure your child.



4-C Forward-Facing
with Seat Belt



4-C Forward-Facing with Seat Belt



17. **Replace the Seat Pad**

Move the headrest back to its proper position for your child.

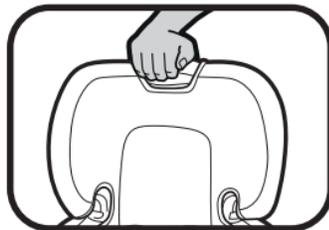

Is Everything Correct?

Car Seat Rotated to the Forward-Facing Position and Car Seat Does Not Move More than 1" (2.5 cm) at the Belt Path

Level Indicator's Bubble in the Orange Zone and Vehicle on Level Ground



Harness Straps at or Just Above the Child's Shoulders

Review section 5

Chest Clip Even With Armpits

Review section 5

Cannot Pinch Harness Straps at the Shoulder

Review section 5

91



4-C Forward-Facing with Seat Belt

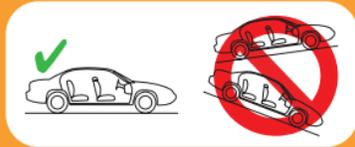

5 Securing Child 5-Point Harness

!WARNING!

WARNING! In cold weather, do not put snowsuits or bulky garments on your child when placing them in the car seat. Bulky clothing can prevent the harness straps from being tightened properly. To keep child warm, buckle your child in the car seat and place a blanket around the child or place the child's coat on backwards after buckling in.



5-A Securing Child 5-Point Harness

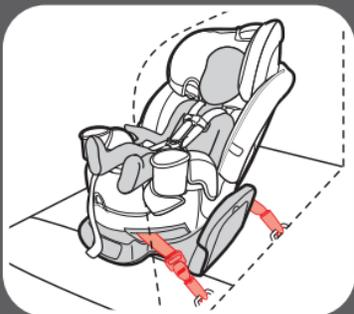

Seat Rotated Towards Vehicle Door

When securely installed in the vehicle in rear-facing mode the car seat can be rotated to face the door to easily secure and remove your child.

When installed in the vehicle in forward-facing mode the car seat **CANNOT** be rotated.

Before securing your child, make sure the car seat is firmly installed, and the vehicle is not in motion.



5 Securing Child 5-Point Harness

1. Rotate the car seat

If securing you child in forward-facing mode, skip to step 2.

The rotation levers are located underneath each armrest. You only need to use one lever to rotate the car seat.

At the same time, slide the blue trigger and squeeze the gray lever. Then rotate the seat toward you.

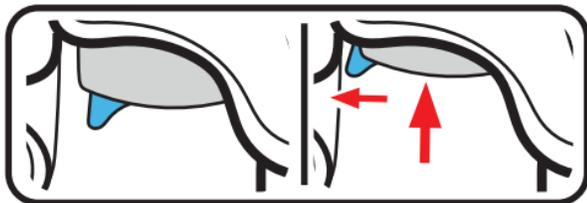

2. Loosen Harness Straps

(A) Lift up on the harness release lever while pulling out on the harness straps at the chest clip.

(B) Unbuckle the chest clip and the buckle **(C)**.

Place harness straps off to the sides.

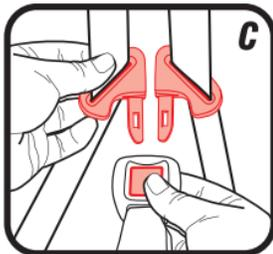

93

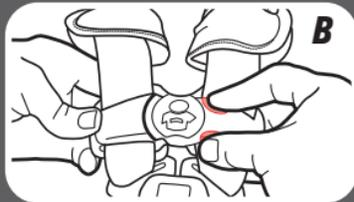
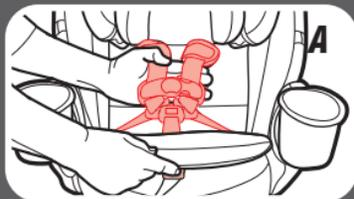
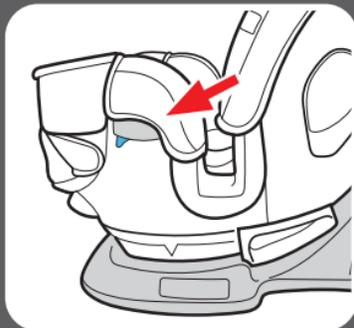

5 Securing Child 5-Point Harness

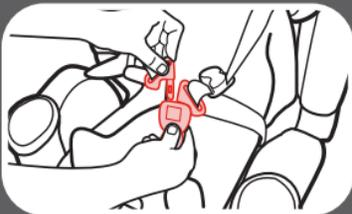
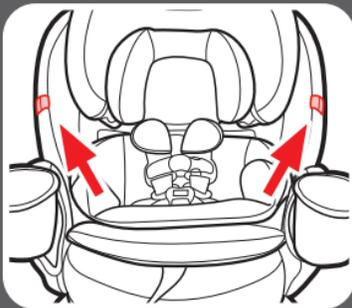

3. Buckle Tongue Storage Pockets

Place buckle tongues in the buckle tongue storage pockets on both sides of the seat.

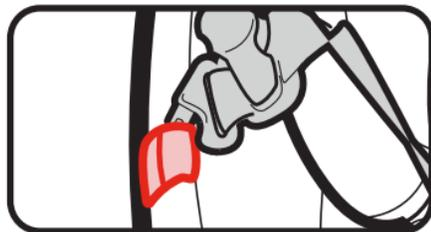

4. Place Your Child in the Seat

Make sure their back is flat against the car seat back.

5. Place Harness Straps Over Child's Shoulders and Buckle

You will hear a "CLICK!" when buckle tongues are securely attached. Pull up on each buckle tongue to make sure it is securely attached.

6. Be Sure the Harness Straps Are at the Proper Height

Rear-Facing: Harness straps must be **at or just below** the child's shoulders and top of head **must be at least 1" (2.5 cm) below** the headrest/harness adjustment handle.

Forward-Facing: Harness straps must be **at or just above** the child's shoulders and top of child's ears **must be below** top of headrest. Remove the infant head and body supports.

7. To Raise or Lower Headrest/Harness Adjustment Lever

Squeeze the adjustment lever and lift or lower headrest for the proper harness height.



95



Rear-Facing



Forward-Facing

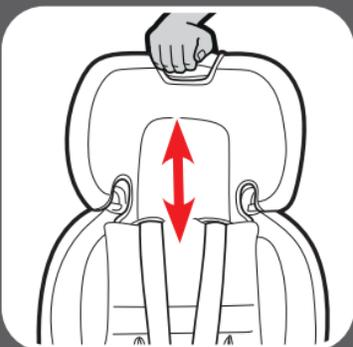

5 Securing Child
5-Point Harness

5 Securing Child 5-Point Harness

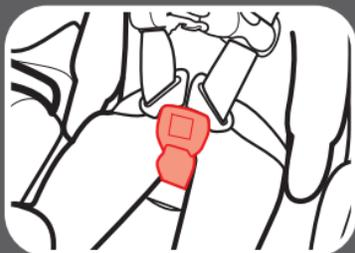

8. Check the Buckle Position

The correct slot is the one that is closest to your child without being underneath your child.

9. To Adjust Buckle Strap

Press the button on the front of the car seat and lift up to open the door. Locate the metal retainer on the underside of the door.

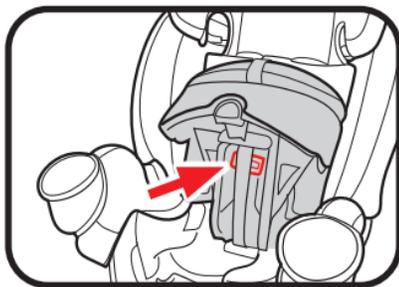

10. Rotate Metal Retainer and Insert It Up Through the Shell and Pad

From the top of the car seat, pull the buckle out.

11. Insert Metal Retainer in the New Buckle Strap Slot

Reach underneath the door and pull the metal retainer through.

12. Close the door

Lower the door back down. The door is secure when you hear a “CLICK!”

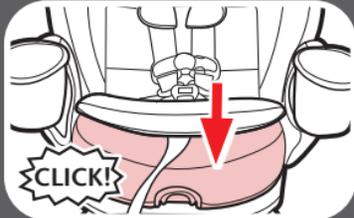
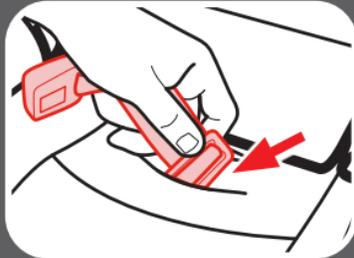
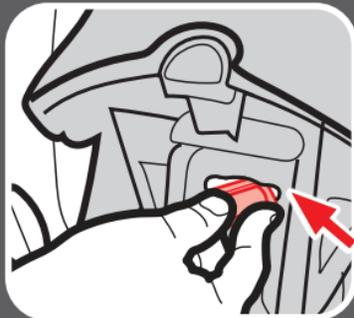

**5 Securing Child
5-Point Harness**

5 Securing Child 5-Point Harness

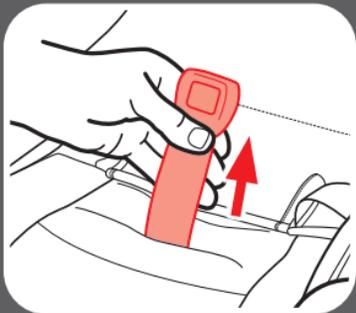

13. Pull Up on Buckle Strap to Make Sure it is Secured

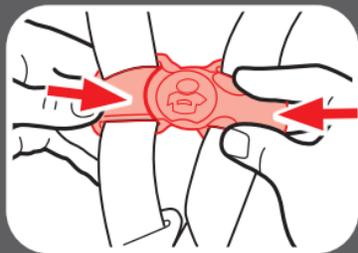

14. Buckle the Chest Clip

You will hear a “CLICK!” when the chest clip is securely buckled.



5 Securing Child 5-Point Harness

15. ***Pull All the Slack Out From Around the Waist***

Pull up on the harness strap while pushing the chest clip down. Do this to both sides.

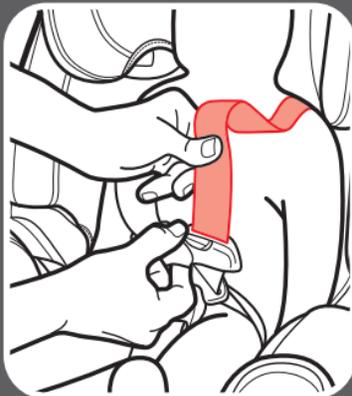

16. ***Tighten the Harness by Pulling the Harness Adjustment Strap***

When you are not able to pinch any of the harness webbing at your child's shoulder, the harness is tight enough.

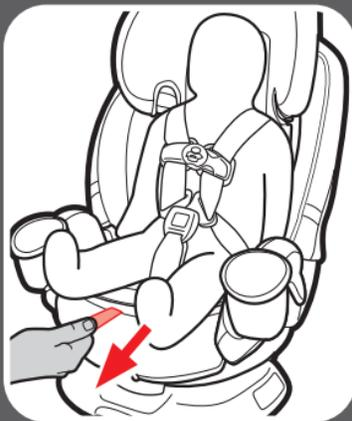

5 Securing Child 5-Point Harness

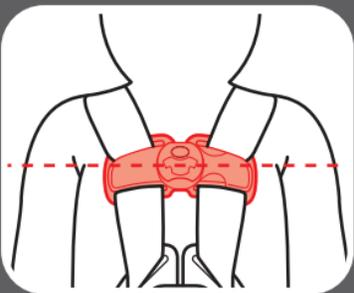
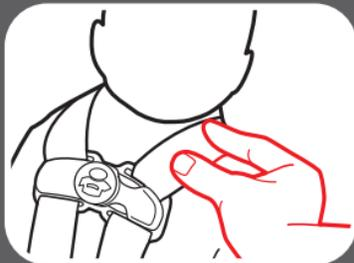

A snug harness should not allow any slack. It lies in a relatively straight line without sagging. It does not press on the child's flesh or push the child's body into an unnatural position.

17. Raise the Chest Clip to Child's Armpit Level

18. Check Tightness Again, Tighten More if Needed

19. Rotate the car seat

If securing your child in forward-facing mode, skip this step.

With your child secured, rotate the seat to the rear-facing position. The seat is correctly in the rear-facing position when the arrow points to the blue label.

The seat is securely locked in position when you hear a “CLICK!” Grab the sides of the seat and try to rotate the seat without using the turn lever to make sure it is securely locked in place.

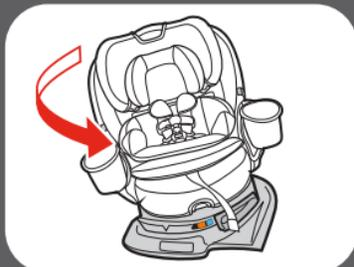
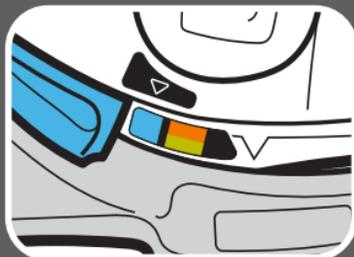

6-A Booster Use



**Vehicle Lap/Shoulder
Seat Belt**



**Never Use a Vehicle
Lap-Only Belt Across
Front of Child**

Highback Booster:

- **40-100 lb (18.1-45 kg)**
- **43-57 in. (110.1-145 cm)**
- **At least 4 years old**

- ✓ Make sure the seat is in forward-facing position by checking if the Seat Position Indicator on the side of the seat is pointing to the orange and green label.
- ✓ Make sure the seat is in the 1st recline position.
- ✓ Make sure the car seat is placed forward-facing in the vehicle back seat.
- ! Vehicle's seat headrest **SHOULD NOT** create a gap between vehicle seat and booster seat.
- ✓ Make sure the front of booster seat is **NOT** hanging over front of vehicle seat.
- ✓ Make sure vehicle seat's lap belt is adjusted snugly and lays low on the child's hip and is routed behind the armrest in the booster's belt path marked with green label.



6-A Booster

- ! **DO NOT** position vehicle belt over top of armrests.
- ✓ Make sure the vehicle seat's shoulder belt is adjusted snugly and lays between child's neck and edge of shoulder.
- ! **DO NOT** position vehicle shoulder belt under the child's arm or back.
- ! Vehicle belts **MUST** lie flat against child and **MUST NOT** be twisted.
- ! **Never** use a vehicle lap-only belt across front of child.
- ! **DO NOT** allow child to slouch or slide down in the booster seat.
- ! If child will not keep vehicle belt properly positioned, **DO NOT** use this booster seat. Use a different car seat.

When forward-facing, children should use the built-in harness system for as long as possible until they reach the maximum forward-facing weight or height for their car seat. At that point, children should ride in a belt-positioning booster seat. A booster is no longer needed once the vehicle seat belt fits properly, typically when they reach 4 feet 9 inches (145 cm) tall and are between ages 8-12. Be sure to check your local and state laws, as well as AAP and NHTSA recommendations, for car seat usage.

103

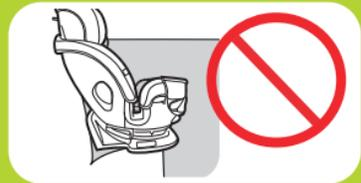

**6-A
Booster**

Continue reading on the next page to learn how to install this car seat!

6-B Install Highback Booster

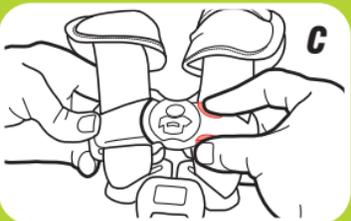
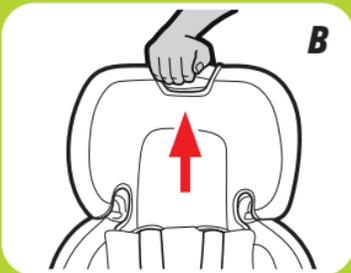
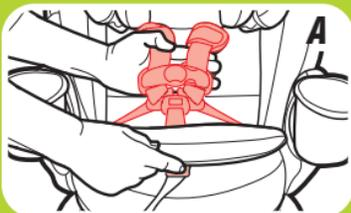

1. Store The Harness System

A. Loosen the shoulder straps as much as possible.

B. Raise the headrest to the highest position.

C. Unbuckle the chest clip and the buckle strap D.

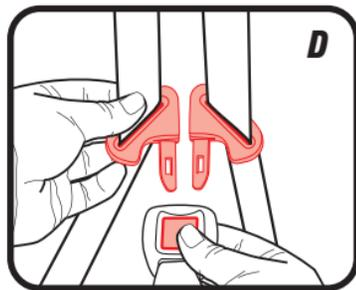

6-B Highback
Booster

2. Remove the Buckle Strap

Press the button on the front of the car seat and lift up to open the door. Locate the metal retainer on the underside of the door.

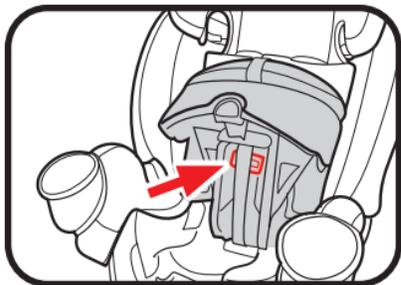

3. Rotate Metal Retainer and Insert It Up Through the Shell and Pad

From the top of the car seat, pull the buckle out.

Lower the door back down. The door is secure when you hear a “CLICK!”.

105



6-B Highback
Booster



6-B Highback Booster

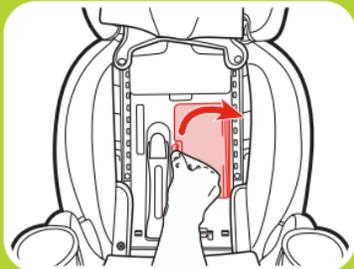
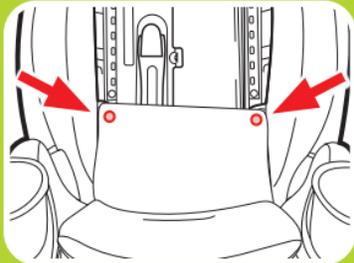
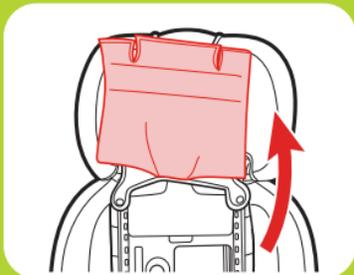

4. Lift The Headrest Pad Flap Up Out Of The Way

5. Unsnap Bottom Seat Pad

Undo the 2 lower snaps.

6. Open the Harness Storage Door

7. Place Harness, Chest Clip, Buckle, Buckle Tongues, and Buckle Strap Inside Storage Compartment, then Close the Door

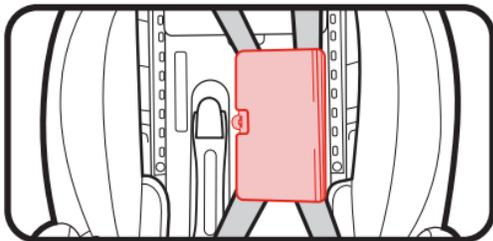

8. Replace Seat Pad

Move the headrest back to its proper position for your child.

9. Rotate The Car Seat Into The Forward-Facing/Booster Position

At the same time, slide the blue trigger and squeeze the gray lever. Then slide the seat in either direction into the forward-facing/booster position. The seat is correctly in the forward-facing/booster position when the arrow points to the orange and green label. The seat is secure when it “clicks” into place.

107

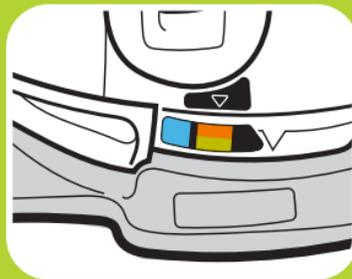
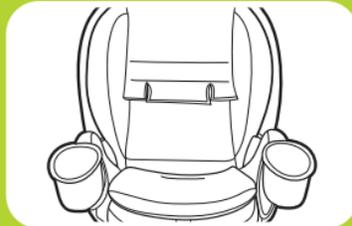
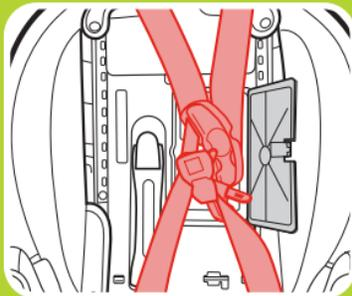

**6-B Highback
Booster**



6-B Highback Booster

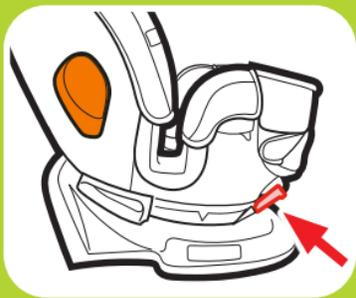

10. Recline the Car Seat

Car seat **MUST** be in recline position 1.

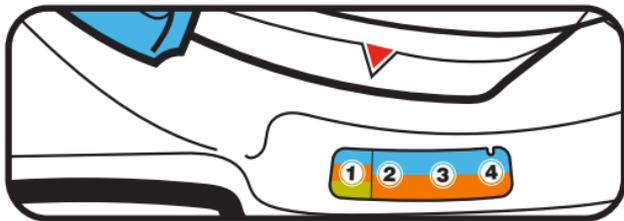

11. Place the Booster Seat Forward-Facing in the Back Seat of Vehicle

Place forward-facing on a vehicle seat that has a lap/shoulder seat belt. The base should sit as flat as possible on the vehicle seat.

Slide the seat until it touches the vehicle seat back.

Graco allows the securing of the car seat with LATCH in the booster mode only if the vehicle manufacturer allows it. The child still **MUST BE SECURED** with the vehicle lap/shoulder seat belt. LATCH can be used in the booster mode regardless of the weight of the child up to 100 lb (45 kg).

Verify the following before using LATCH in the booster mode:

- The lower anchor connectors **DO NOT** interfere with any vehicle seat belts or buckles.

If the lower anchor connectors interfere with the vehicle seat belts or if the chosen seating position does not have lower anchors, you **MUST** store the lower anchor connectors. Store the lower anchor connectors in the storage location as shown. Store the tether strap as shown. Always secure car seat with lower anchor attachment or a vehicle seat belt, even when unoccupied. In a crash, an unsecured car seat can injure passengers.

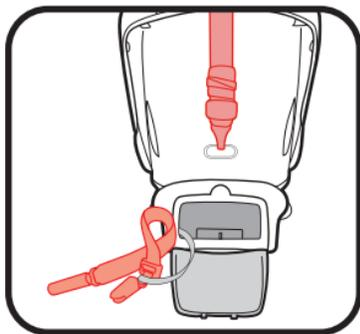

6-B
Highback
Booster

Skip to Step 25 if Not Using LATCH

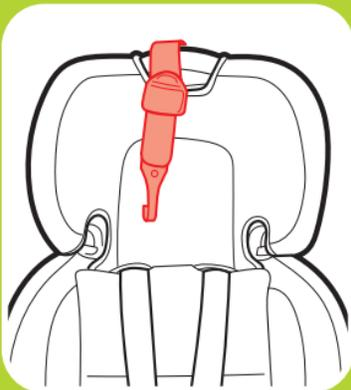

12. Unhook Tether Strap From Storage

Unhook tether and lay it in the seat.

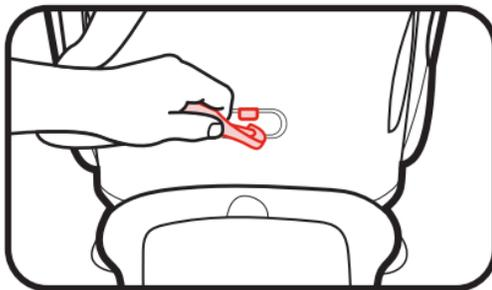

13. Remove Lower Anchor Connectors from Storage Location

Open the lower anchor storage door on the base of the car seat and remove the lower anchor connectors from the storage compartment. Close the storage compartment door.

14. Extend the Lower Anchor Strap

For easier installation, extend the lower anchor strap to its maximum length by pressing the grey button and pull out on the strap.

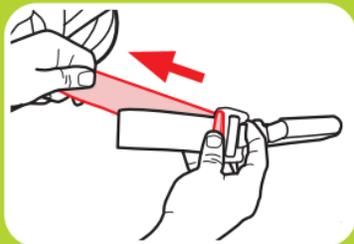

15. Route the Lower Anchor Strap

Thread the lower anchor strap through the orange forward-facing belt path and out the other side. The strap should lie as flat as possible and not be twisted.



6-B
Highback
Booster



6-B Highback Booster



16. Expose the SnugLock® Lock-Off

- A.** Raise the headrest to the highest position.

B. Lift the headrest pad flap up out of the way.

C. Undo the 2 lower snaps.

17. Open the SnugLock® Lock-Off

Pull the lever to open the SnugLock® lock-off.

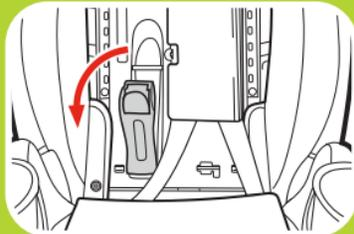
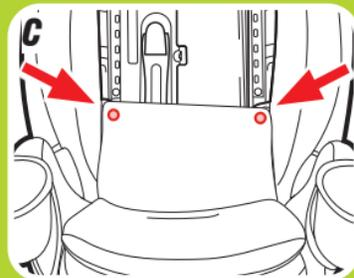
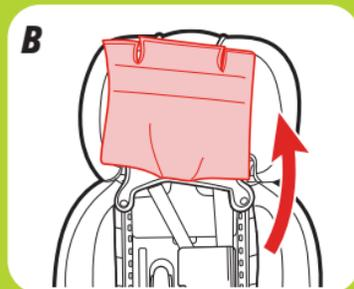

**6-B Highback
Booster**



6-B Highback Booster

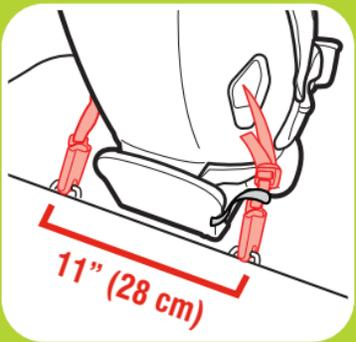
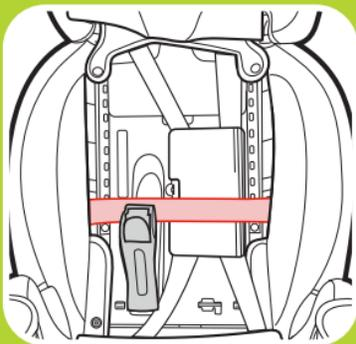

18. Make Sure the Lower Anchor Strap is Routed Under the SnugLock® Lock-Off

The lower anchor strap should lie as flat as possible and not be twisted.

19. Connect the Lower Anchor Connectors to Vehicle's Lower Anchors

Lower anchor strap should not be twisted. If twisted, you will not be able to tighten the strap.



Make sure the arrows are pointing up.

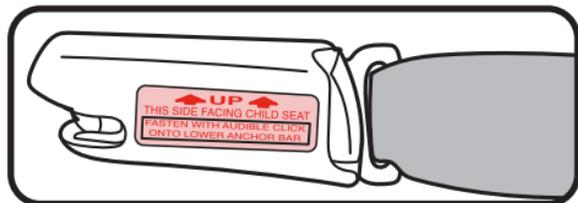

Lower anchor connectors can only be used if the vehicle lower anchor spacing is 11 inches (28 cm) from the center of one lower anchor to the center of the other lower anchor.

20. Tighten the Lower Anchor Strap

Press down firmly in the center of the car seat while tightening the lower anchor strap. You may need to tighten through the belt path as shown. **Do not pull on the belt with excessive force. If the belt is too tight, you will not be able to close the SnugLock® Lock-Off.**

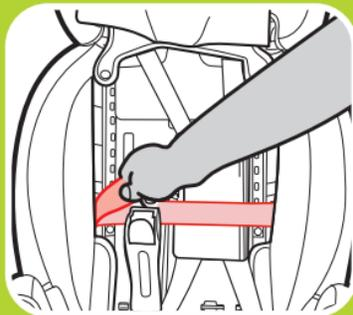
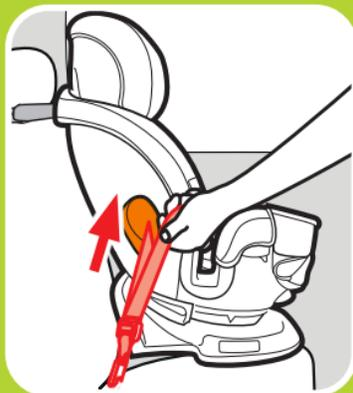

6-B Highback
Booster



6-B Highback Booster

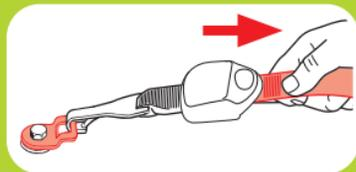
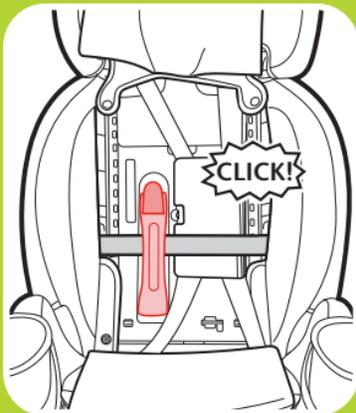

21. Close the SnugLock® Lock-Off

When the slack is removed, close the SnugLock® Lock-Off until you hear a “CLICK!”. Make sure the Lower Anchor strap is under the SnugLock® Lock-Off.

! WARNING!

Keep hands away from the lock-off area when closing the lock-off.

22. Attach Tether Strap

Extend the tether by lifting up on the tether lock and attach.

Consult vehicle owner’s manual for specific location.

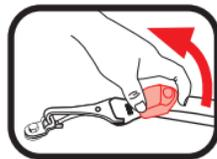

23. Tighten Tether Strap

Remove all the slack.

24. Replace the Seat Pad

Move the headrest back to its proper position for your child.

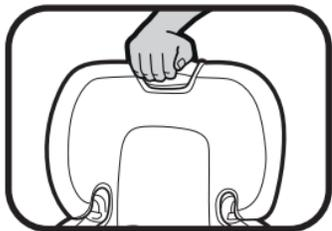

25. Thread the Vehicle Seat Shoulder Belt Through Seat Belt Guide on the Headrest

See section 6-C to secure your child.

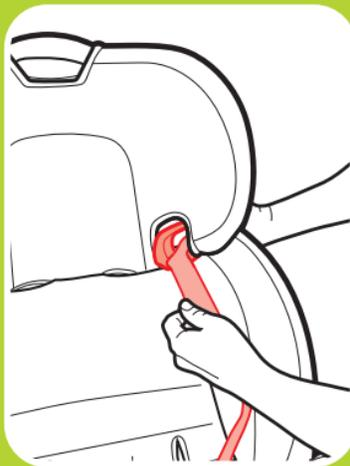

**6-B Highback
Booster**



6-C Securing Child Highback Booster

6-C Securing Child Highback Booster



!WARNING!

Use only the vehicle lap and shoulder belt system when restraining the child in the booster seat.

1. Place Child In Seat

Have your child sit in the booster seat, with his/her back flat against the back of the booster seat.

2. Thread Vehicle's Shoulder Belt Into Seat Belt Guide in the Headrest

3. Buckle the Vehicle Lap/Shoulder Seat Belt

Be sure the lap portion of the vehicle seat belt goes behind the armrests.

Be sure the lap portion of the vehicle seat belt lies low across your child's hips.

Be sure the shoulder belt lies across your child's shoulders, between the neck and edge of shoulder. The belt guides should be even with or just above the shoulders.

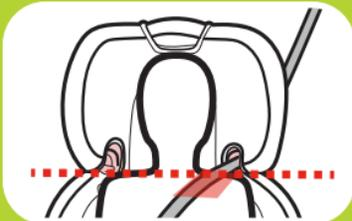
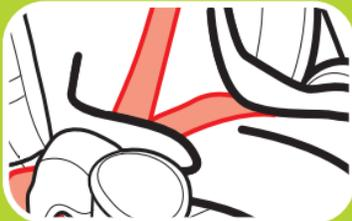
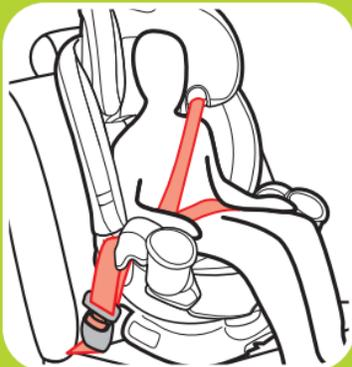

**6-C Securing Child
Highback Booster**



Is Everything Correct?



Never Use Lap Belt Only

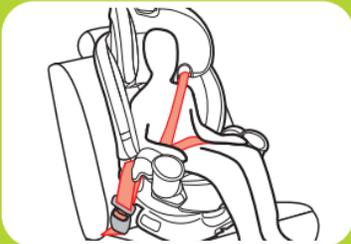

Lap Belt Behind Armrest and Lies Low Across Hips and Thighs

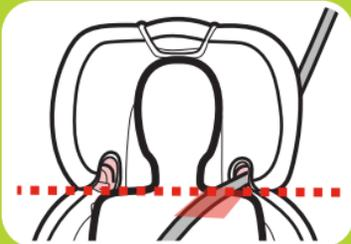

Shoulder Belt Lies On the Shoulder, Between the Neck and Edge of Shoulders

7 Accessories



7 Accessories

Harness Covers

Make sure that harness covers do not interfere with placement of the chest clip at armpit level.
To remove, undo the fastening strips and remove.

The head support and body support MUST be used together.

Infant Body Support

Use only in the rear-facing mode. Body support must be used if shoulders are below the lowest harness setting.

Never allow body support to bunch or fold behind child.

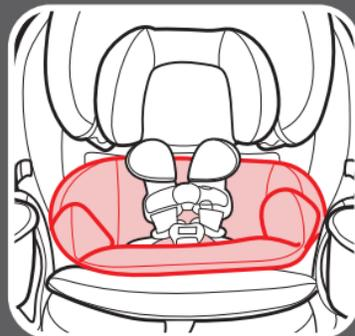
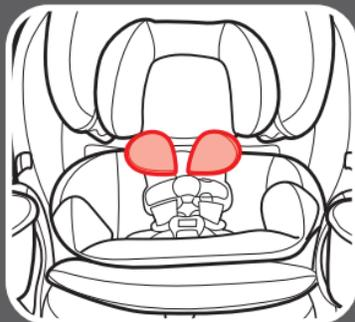



7 Accessories

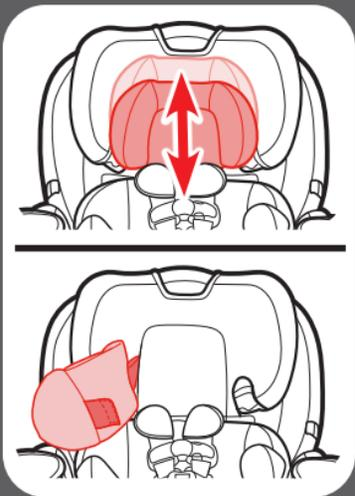

The head support and body support **MUST** be used together.

Infant Head Support

Use only in the rear-facing mode. To adjust the support, pull up until desired height.

To install, thread the head support straps through the headrest and use the fastening strips to connect the straps together.

To remove, undo the fastening strips and pull the straps out of the headrest.

8-A How to Uninstall Lower Anchor Connectors and Tether

Lower Anchor Connectors

To remove the lower anchor connectors from the lower anchors, push in on the red buttons and pull them off.



Tether

To remove, lift up on the tether adjuster to release the tension.

Press in on the hook's spring. Push tether hook in, then lift up and pull away from tether anchor.

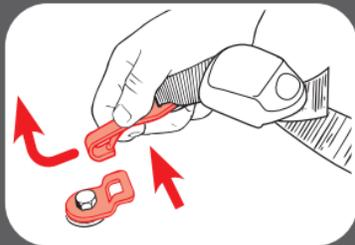
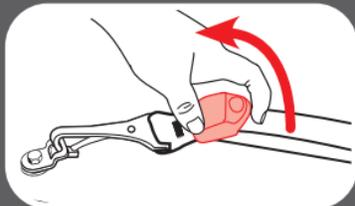

8-B Choosing Vehicle Seat Location

Review your vehicle owner's manual for Seating Locations

The best seating location for this car seat is one that:

- Is recommended by your vehicle owner's manual, and
- Results in a secure installation of this car seat

In the event there is no available back seat and / or you have no other option than to place a child other than an infant in a rear-facing car seat in a front passenger seating position, the National Highway Traffic Safety Administration (NHTSA) recommends that you take the following steps:

- Ensure the child is properly restrained according to their age and size
- Move the seat as far back as possible
- Make sure the child is not leaning out of position, such as leaning forward into the deployment path of the air bag
- Set the air bag ON-OFF switch, if available, to the OFF position
- Move the seat as far back as possible



8-C Unsafe Vehicle Seat Location

Never install this car seat in any of the following vehicle seating locations:



rear-facing or side-facing vehicle seats



rear-facing with an active front air bag



booster mode with vehicle lap belt only seat belt

8-D Vehicle Seat Belts

Review your vehicle owner's manual for vehicle seat belt use

This car seat can be installed using a vehicle seat belt. To do this, you will need to change the seat belt to a locked mode for use with car seats. With some vehicle seat belts, this is done with the latchplate; with other vehicle seat belts, this is done with the retractor.

Vehicle Seat Belt Terms

Retractor

A device that winds up the unused vehicle seat belt. It is often hidden inside the panels on the walls of the vehicle or in the vehicle seatback.

Latch Plate

The male end of the seat belt with the silver tongue.

Seat Bight

The crease where the vehicle seat back and seat bottom meet.

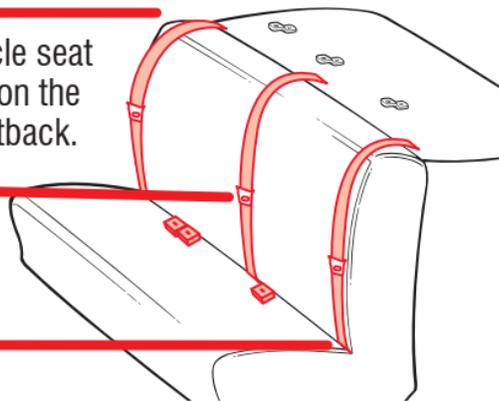

Identify Your Seat Belt Type

There are two different types of vehicle seat belts that can be used with this car seat:

Lap/Shoulder Belt

3 connections points. Can be used in all car seats modes of use.



Lap Belt Only

2 connection points. **Can ONLY be used in harness mode.**

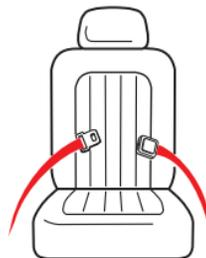

The following types of vehicle seat belts **CANNOT** be used safely with this car seat:



Lap Belt with Motorized Shoulder Belt



Lap Belt or Shoulder Belt Mounted on Door

Belts Forward of the Seat Bight



Some vehicles you may not get a secure fit. Read both your vehicle and car seat manuals.

Lap/Shoulder Belt Installation - Rear-Facing/Forward Facing Modes

Always review your vehicle owner's manual for specific information about your vehicle seat belts.

There are three types of retractors: **ELR (Emergency Locking Retractor)**, **ALR (Automatic Locking Retractor)**, and **Switchable (ELR switch to ALR)**. To determine your type of retractor, follow these steps:

1. **Slowly** pull the belt out about halfway and stop.
2. Let the belt retract back several inches.
3. Try to **slowly** pull the belt out more. If the belt cannot be pulled any further, it is **ALR**. If it can be pulled further, go to the next step.
4. **Slowly** pull the belt all the way out, and then allow it to retract several inches.
5. Try to pull the belt all the way out again. If it cannot be pulled out, it is **Switchable**. If it can still be pulled out freely, it is **ELR**.

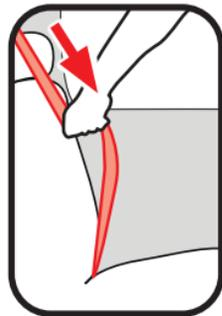

Note: Most vehicles manufactured after 1996 will have Switchable retractors in the back seat. If you have any questions about your retractor type, consult your vehicle owner's manual or call Graco for assistance.

How to Lock Your Lap and Shoulder Vehicle Seat Belt

Sliding Latch Plate and Switchable Retractor

A latchplate that slides freely on the belt webbing and cannot, by itself, hold the belt snug around a car seat. When installing the car seat, route the vehicle seat belt through the proper belt path and buckle it in. **Slowly pull the shoulder belt all the way out to switch it to locking mode.** Then, as you pull the vehicle seat belt tight, feed all the slack back into the retractor. Grab the sides of the seat at the belt path and slide the seat side-to-side and front-to-back. The seat should not move more than 1" (2.5 cm).

- When using the SnugLock® lock-off, route the vehicle seat belt into the proper belt path under the lock-off and buckle. Push down firmly on the center of the seat while pulling on the shoulder belt to remove the slack. Do not pull on the strap with excessive force. Close the SnugLock® lock-off. Test for tightness. Slowly pull the shoulder belt all the way out to switch it to locking mode.

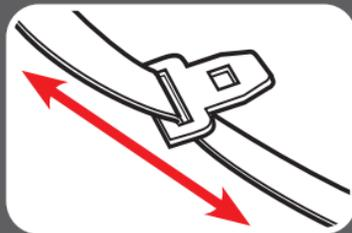

8
Additional
Information

8 Additional Information

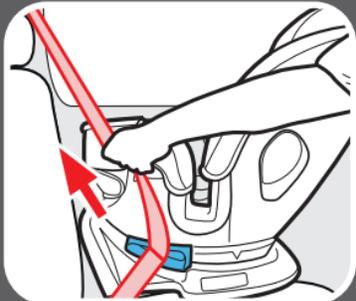
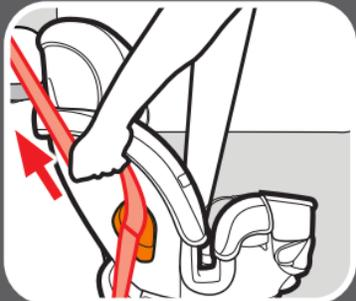
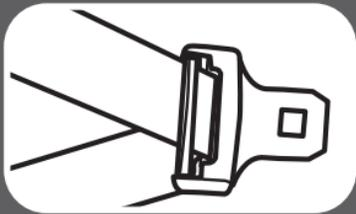

Locking Latchplate and ELR Retractor

A latchplate that holds the lap belt snug after it has been adjusted; contains a metal bar on the underside of the hardware that “locks” the belt in position.

When installing the car seat, route the vehicle seat belt through the proper belt path and buckle it in. Then, pull upwards on the shoulder belt so that the lap belt gets tight around the car seat.

Grab the sides of the seat at the belt path and slide the seat side-to-side and front-to-back. The seat should not move more than 1” (2.5 cm).

- When using the SnugLock® lock-off, route the vehicle seat belt into the proper belt path under the lock-off and buckle. Push down firmly on the center of the seat while pulling on the shoulder belt to remove the slack. Do not pull on the strap with excessive force. Close the SnugLock® lock-off. Test for tightness. Slowly pull the shoulder belt all the way out to switch it to locking mode.

Sliding Latch Plate and ALR Retractor

A latchplate that slides freely on the belt webbing and cannot, by itself, hold the belt snug around a car seat.

Slowly pull the shoulder belt all the way out. Route the vehicle seat belt through the proper belt path and buckle it in. Then, as you pull the vehicle seat belt tight, feed all the slack back into the retractor.

Grab the sides of the seat at the belt path and slide the seat side-to-side and front-to-back. The seat should not move more than 1" (2.5 cm).

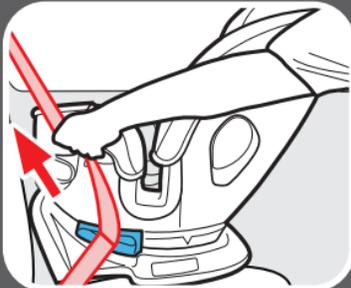
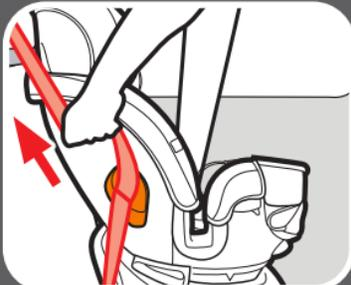
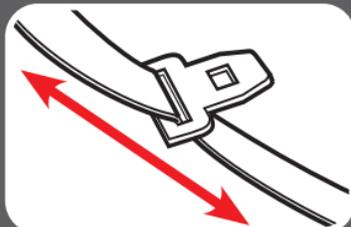

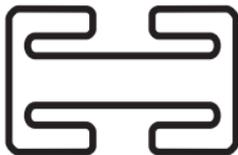
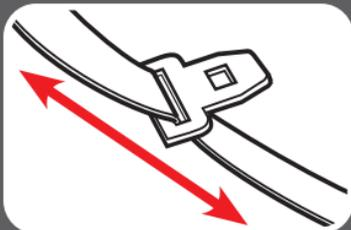

Locking Clip



Sliding Latch Plate and ELR Retractor

A latchplate that slides freely on the belt webbing and cannot, by itself, hold the belt snug around a car seat.

With this retractor, you will need to use a locking clip to lock the vehicle seat belt.

To get a locking clip order online at gracobaby.com or call 1-800-345-4109

Route the vehicle seat belt through the proper belt path and buckle it in. Pull the vehicle seat belt tight. While pushing down on seat, pinch the two straps together behind the buckle tongue. Unbuckle the belt without allowing it to slip.

Attach locking clip to lap and shoulder belts as shown.

Rebuckle belt. Check that lap belt does not move by pulling hard. If belt loosens or lengthens, repeat procedure.

Note: When using the lock-off, you do not need to use the locking clip. The lock-off locks the seat belt.

Lap Belt Installation - DO NOT use in Booster Mode

Always review your vehicle owner's manual for specific information about your vehicle seat belts.

Locking Latch Plate and No Retractor

When installing the car seat, route the lap seat belt through the proper path and buckle it in. Then, pull upwards on the tail of the belt so that the lap belt gets tight around the car seat.

Sewn On Latch Plate and ALR

Slowly pull the lap belt all the way out. Route the vehicle seat lap belt through the proper belt path and buckle it in. Then, pull the lap belt tight while feeding all the slack back into the retractor.



Grab the sides of the seat at the belt path and slide the seat side-to-side and front-to-back. The seat should not move more than 1 " (2.5 cm).



8-E Aircraft Installation

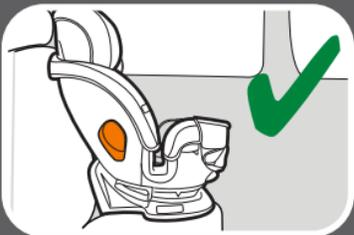

This child restraint is certified for use in aircraft only when used with the internal harness system in forward-facing mode, and **ONLY** when not using the SnugLock[®] lock-off. Use only on forward-facing aircraft seats.

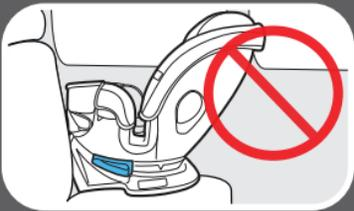

This child restraint is **NOT** certified for use in aircraft when used in rear-facing mode, or as a booster seat because aircrafts do not have shoulder belts.

NEVER use a vehicle lap-only belt across front of child.



1. Rotate the car seat into the forward-facing position

At the same time, slide the blue trigger and squeeze the gray lever. Then slide the seat in either direction into the forward-facing position. The seat is correctly in the forward-facing position when the arrow points to the orange and green label. The seat is secure when it “clicks” into place.

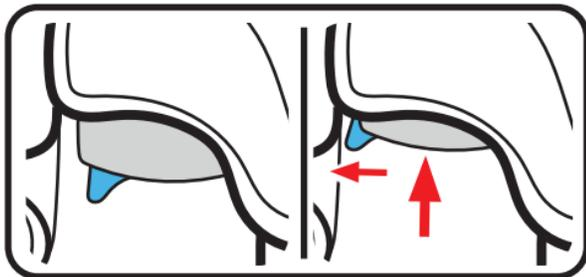

8

**Additional
Information**

8 Additional Information

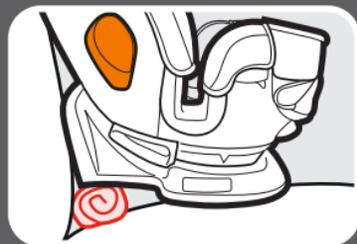

2. **Store Lower Anchor Connectors in Storage Location**

Make sure to store the lower anchor connectors in the storage compartment in the seat base.

3. **Check the Level Indicator**

Check the level indicator on the car seat. The **bubble must be completely within** the orange zone.

Adjust the recline until the bubble is completely within the orange zone.

If needed, rolled towels may be placed under the car seat at the vehicle seat crease, until the ball is completely in the orange zone.

4. **Route the Aircraft Seat Belt Over the SnugLock® Lock-off**

Thread the aircraft seat belt through the orange forward-facing belt path and out the other side. Buckle the seat belt and tighten it. The seat belt should lie as flat as possible and not be twisted.

Note: It may be easier to route the aircraft seat belt by lifting seat pad up to expose the belt path.

Make sure the aircraft seat belt is routed behind the harness straps, is flat, and is not twisted.

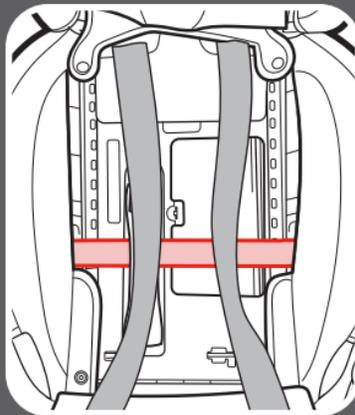
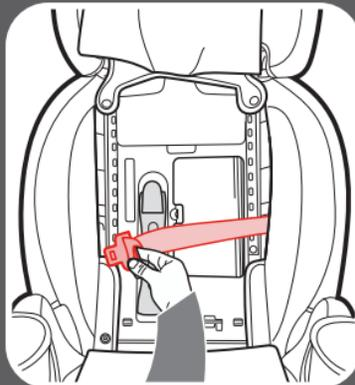

9-A Cleaning Seat Pad

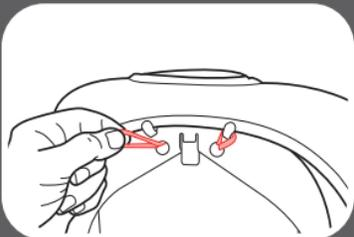
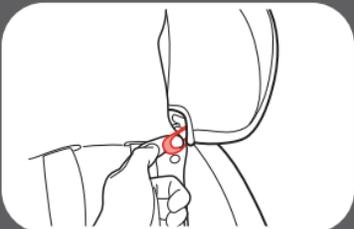
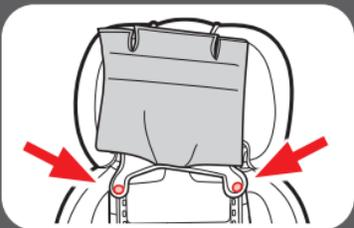

Refer to seat pad care tag for washing instructions.

Headrest Pad

Clean with a damp sponge using mild soap and cool water. If needed, pad may be removed for cleaning.

To remove, unsnap the 2 outer headrest pad snaps.

Slide the elastic retaining loops out of the belt guides.

Undo the 2 elastic straps from the back of headrest.

Remove the headrest pad.

Machine wash pad in cold water on delicate cycle and drip-dry. **DO NOT USE BLEACH.**

Reverse the steps to reattach the pad on the headrest.

Seat Pad

Clean with a damp sponge using mild soap and cool water. If needed, pad may be removed for cleaning.

To remove the seat pad, undo the 2 snaps.

Then pull the pad away from the 2 fastening strips.

Machine wash pad in cold water on delicate cycle and drip-dry. **DO NOT USE BLEACH.**

Reverse the steps to reattach the pad to the shell.

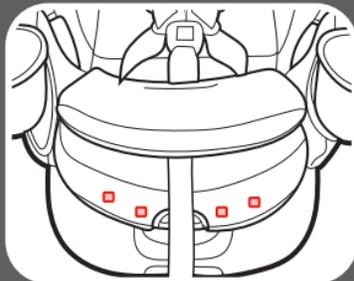
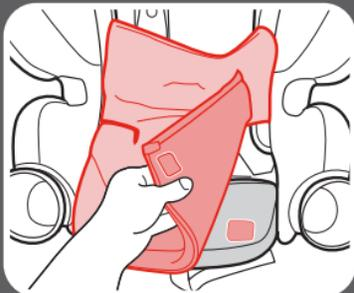
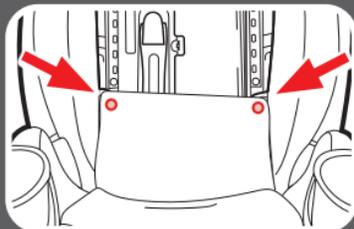

Care & 9 Cleaning

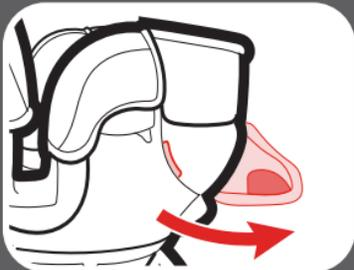
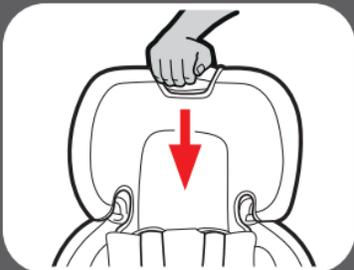
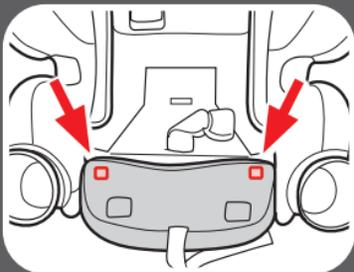

Then pull out the 2 pins on the top of the door.

Machine wash cover in cold water on delicate cycle and drip-dry. **DO NOT USE BLEACH.**

Reverse the steps to reattach the cover to the shell.

Side Pad

Clean with a damp sponge using mild soap and cool water. If needed, pad may be removed for cleaning.

To remove, first adjust the head support to its lowest position.

Pull out the tabs from below the cup holders.

Pull the fabric out from around the corner near the rear of the cup holders.

Pull out the 2 pins from the booster belt path.

On the back of the seat, undo the 2 hooks from the top of the shell.

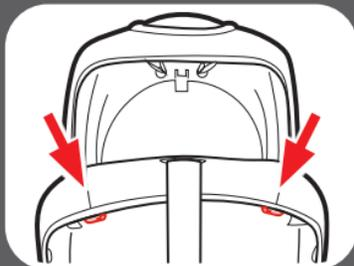
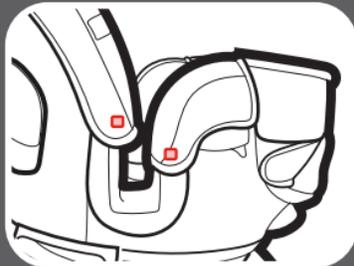
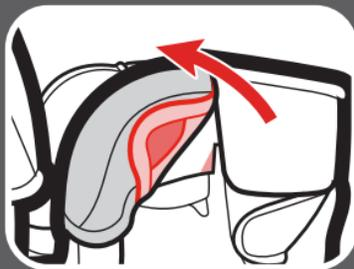



Care & 9 Cleaning

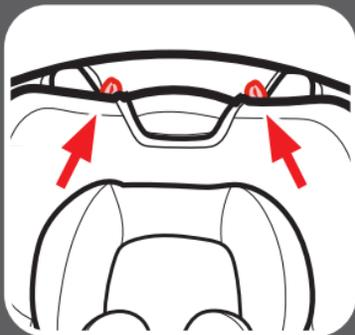

Finally, unhook the 2 elastic loops at the top of the shell, just above the head support.

Pull the side pads from the shell.

Machine wash pad in cold water on delicate cycle and drip-dry. **DO NOT USE BLEACH.**

Reverse the steps to reattach the pad to the shell.

9-B Cleaning Crotch Buckle

Press the button on the front of the car seat and lift up to open the door. Locate the metal retainer on the underside of the door. Rotate the metal retainer up through the shell and pad. From the top, pull the buckle strap out.

To clean buckle, place in a cup of warm water and gently agitate the buckle. Press the red button several times while in the water.

DO NOT SUBMERGE THE BUCKLE STRAP. DO NOT USE SOAPS, HOUSEHOLD DETERGENTS or LUBRICANTS.

Shake out excess water and allow to air dry. Repeat steps as needed until it fastens with a click. Re-insert the buckle into the same slot it was removed. Pull up on buckle strap to make sure it is secured.

WARNING! Inspect and clean buckle from time to time to remove any objects or debris that could prevent latching.

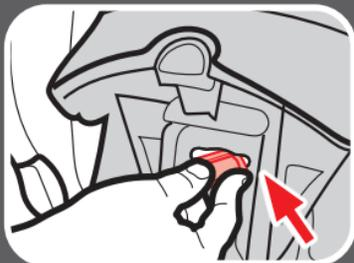
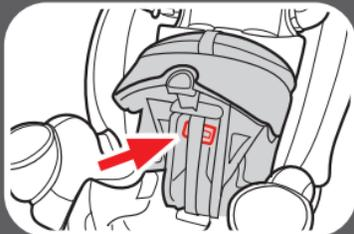

9 Care & Cleaning

9-C Cleaning Harness, Lower Anchor Attachment and Tether

Surface wash only with mild soap and damp cloth. **DO NOT IMMERSE THE HARNESS STRAPS, LOWER ANCHOR STRAP, or TETHER STRAP IN WATER.** Doing so may weaken the straps.

If harness straps, lower anchor strap or tether strap are frayed or heavily soiled, contact Customer Service at www.gracobaby.com or 1-800-345-4109.



Notes

Notes

Notes

Replacement Parts

To purchase parts or accessories in the United States,
please contact us at the following:

www.gracobaby.com

or

1-800-345-4109



Store instruction manual in
the slot with the instruction
book icon as shown.

